

NJM2900/3900

The NJM2900/3900 consist of four independent, dual input, internally compensated amplifiers which were designed specifically to operate off of a single power supply voltage and to provide a large output voltage swing. These amplifiers make use of a current mirror to achieve the non-inverting input function. Application areas include: ac amplifiers, RC active filters, low frequency triangle, squarewave and pulse waveform generation circuits, tachometers and low speed, high voltage digital logic gates.

Package Outline

Absolute Maximum Ratings (Ta=25°C)

Supply Voltage	V ⁺ (2900)	+36V (±18V)
	V ⁺ (3900)	+32V (±16V)
Power Dissipation	P _D (N-Type)	500mW
	(M.E-Type)	300mW
Input Current	I _{IN}	20mA
Operating Temperature Range	T _{opr} (2900)	-40~+85°C
	T _{opr} (3900)	-20~+75°C
Storage Temperature Range	T _{stg}	-40~+125°C

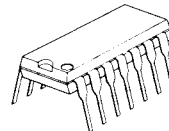

NJM2900N
NJM3900N

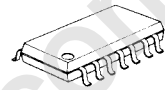

NJM2900M
NJM3900M



NJM2900E
NJM3900E

Electrical Characteristics (Ta=25°C, V⁺=+15V)

Parameter	Symbol	Test Condition	Min.	Typ.	Max.	Unit
Voltage Gain	A _v	Open Loop, f=100Hz	61.5	69	—	dB
Input Resistance	R _{IN}	Open Loop, Inverting Input	—	1	—	MΩ
Output Resistance	R _O	Open Loop	—	8	—	kΩ
Unity Gain Bandwidth	GB	A _v =1, Inverting Input (note 1)	—	2.5	—	MHz
Input Bias Current	I _B	Inverting Input	—	30	200	nA
Slew Rate	SR	Positive Output Swing	—	0.5	—	V/μs
		Negative Output Swing	—	20	—	V/μs
Supply Current	I _{CC}	R _L =∞	—	6.2	10	mA
Output High Voltage Swing	V _{OH}	I _{IN} ⁻ =0, I _{IN} ⁺ =0, R _L =5.1kΩ	13.5	14.2	—	V
Output Low Voltage Swing	V _{OL}	I _{IN} ⁻ =10μA, I _{IN} ⁺ =0, R _L =5.1kΩ	—	0.09	0.2	V
Output Source Current	I _{SOURCE}		6	18	—	mA
Output Sink Current	I _{SINK}	(note 2)	0.5	1.3	—	mA
Power Supply Rejection	SVR	f=100Hz	—	70	—	dB
Mirror Gain	M	I _{IN} ⁺ =200μA (note 3)	0.90	1	1.1	μA/μA
Mirror Current	I _M	(note 4)	—	10	500	μA
Negative Input Current	I _{IN} ⁻	(note 5)	—	1.0	—	mA

note 1. The output sink current capacity can be increased by over-driving the inverting input.

2. This standard shows the current amplification degree of a current mirror when NJM2900/3900 serves as a non-inverting amplifier.

3. The V_{BE} matching of input stage transistors is designed to meet a mirror current of about 10μA.

4. The input clamp transistor is designed in such a way as the input voltage is not lower than about 0.3V. If the negative input current exceeds 4mA, the output may drop to a low voltage.

■ Equivalent Circuit

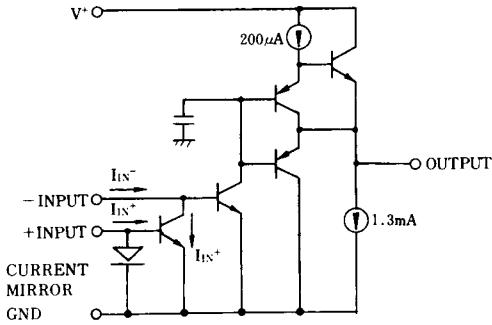

■ Connection Diagram

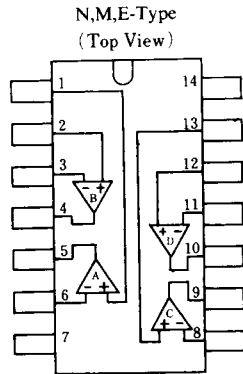

PIN FUNCTION

- | | |
|-------------|--------------------|
| 1. A +INPUT | 14. V ⁺ |
| 2. B +INPUT | 13. C +INPUT |
| 3. B -INPUT | 12. D +INPUT |
| 4. B OUTPUT | 11. D -INPUT |
| 5. A OUTPUT | 10. D OUTPUT |
| 6. A -INPUT | 9. C OUTPUT |
| 7. GND | 8. C -INPUT |

■ Typical Application (V⁺=15V)

Voltage Control Current Source (Transconductance Amp.)

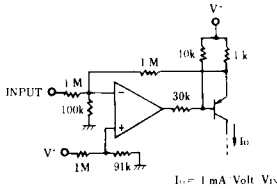

Triangle/Square Wave Generator

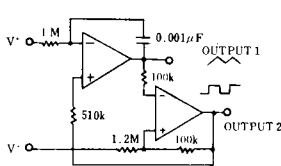

Inverting Amplifier

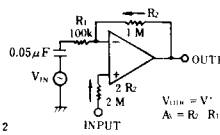

V_{BE} Bias

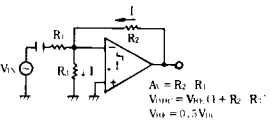

Stepped wave generator/Pulse Counter

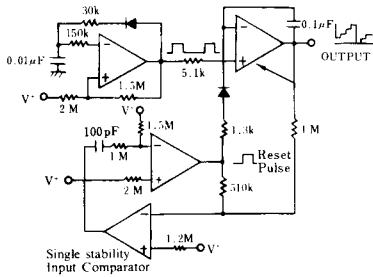

Auxiliary Amp. for In Supply

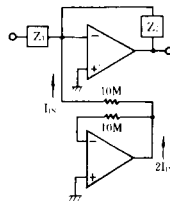

Band Pass Active Filter

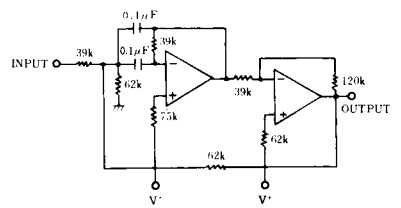

Differential input signal detecting circuit

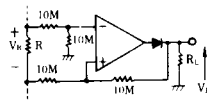

Non-Inverting Amplifier

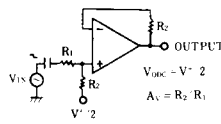

Double Voltage (V⁺/V⁻ = ±15V)

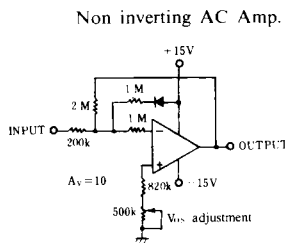

AC Amp.

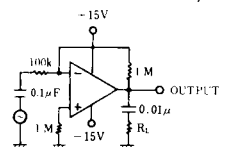

■ Typical Characteristics

Mirror Gain vs. Temperature

($V^+ = 15V, I_{IN} = 10\mu A$)

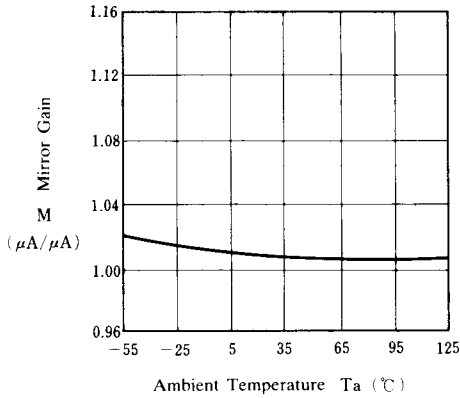

Maximum Mirror Current vs. Temperature

($V^+ = 15V, A_1 \geq 0.90$)

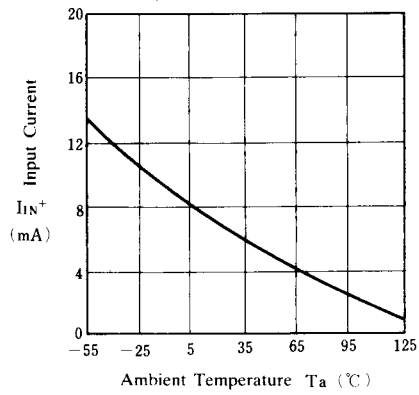

Voltage Gain vs. Frequency

($V^+ = 15V, T_a = 25^\circ C$)

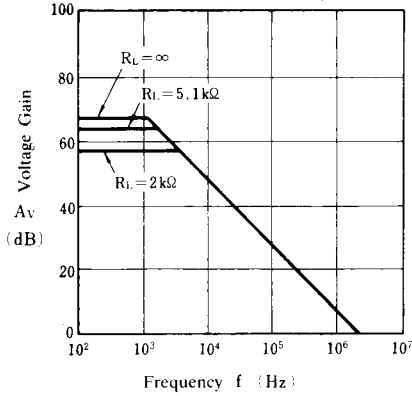

Voltage Gain vs. Supply Voltage

($T_a = 25^\circ C$)

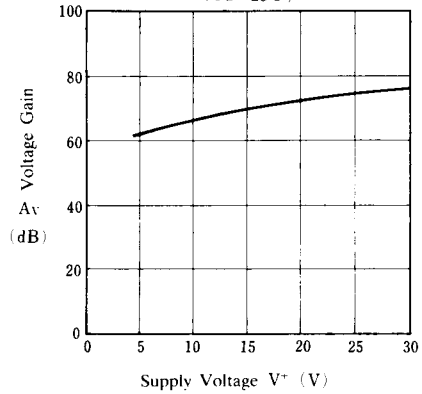

Voltage Gain vs. Temperature

($V^+ = 15V, R_L = \infty$)

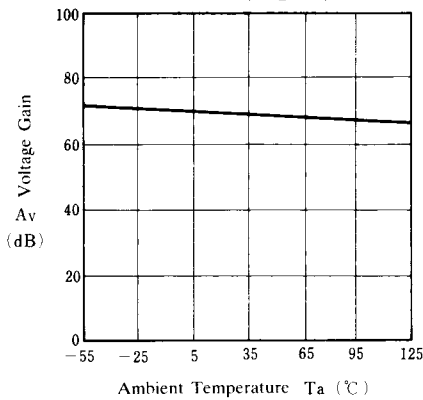

Input Current vs. Temperature

($V^+ = 15V$)

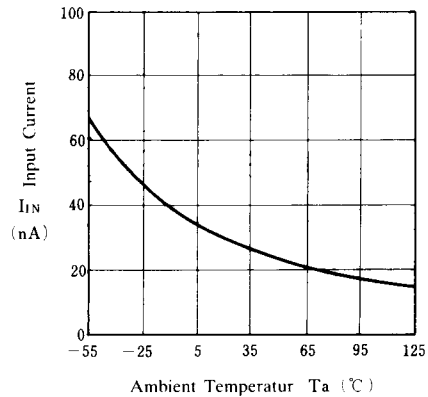

Typical Characteristics

Supply Current vs. Supply Voltage
($R_L = \infty$)

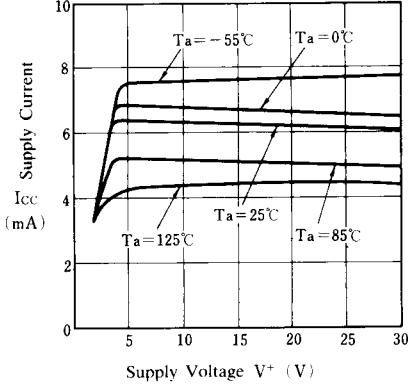

Maximum Output Voltage Swing vs. Frequency

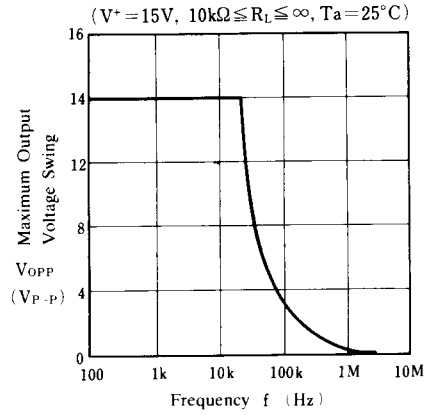

Output Sink Current vs. Supply Voltage
($T_a = 25^\circ\text{C}$)

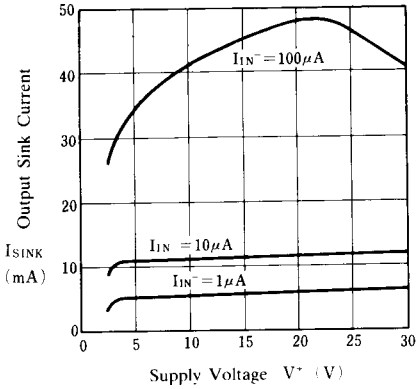

A Class Output Bias Current vs. Supply Voltage

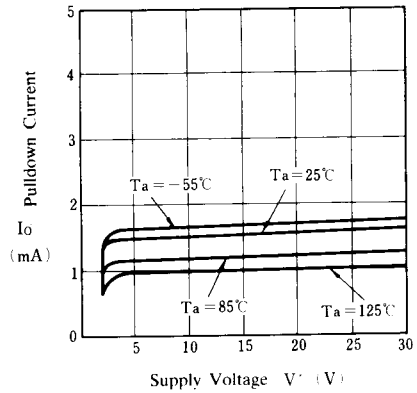

Output Source Current vs. Supply Voltage

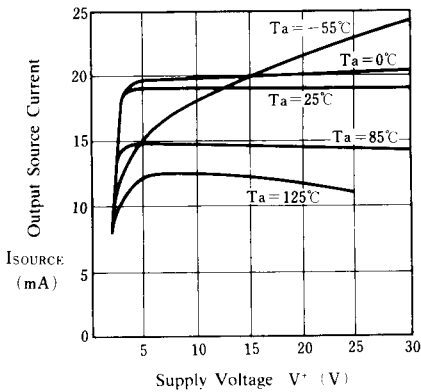

Supply Voltage Rejection vs. Frequency
($T_a = 25^\circ\text{C}$)

