

Ultra-low Quiescent Current, High Efficiency Boost DC-DC Regulator

ADVANCED INFORMATION

FEATURES

- Ultra-low 12 μ A Quiescent Current
- 700mA Output Current at 2.6V_{IN}, 3.3V_{OUT}
- 94% Efficiency Possible
- Wide Input Voltage Range: 0.85V to 4.5V
- 3.3V Fixed Output and adjustable 2.5V to 5.0V Output Range
- Internal Synchronous Rectifier for High Efficiency
- 0.3 Charging Switch, 0.3 Synchronous Rectifier
- Anti-Ringing Inductor Switch
- Programmable Inductor Peak Current
- Logic Shutdown Control
- Under Voltage Lock-Out, 0.62V
- Programmable Low Battery Detect
- Small 10 pin MSOP Package

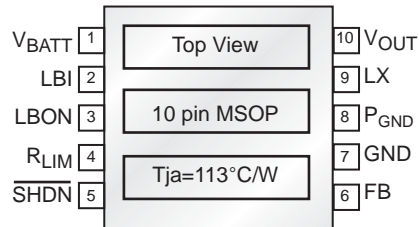

APPLICATIONS

- Digital Still Cameras
- MP3 Players
- PDA's
- Pagers
- Handheld Portable Devices
- Medical Monitors

DESCRIPTION

The SP6649 is an ultra-low quiescent current, high efficiency step-up DC-DC converter ideal for single and dual cell alkaline, or Li-Ion battery applications such as digital still cameras, PDA's, MP3 players, and other portable devices. The SP6649 combines the high delivery associated with PWM control, and the low quiescent current and excellent light-load efficiency of PFM control. The SP6649 features 12 μ A quiescent current, synchronous rectification, a 0.3 charging switch, anti-ringing inductor switch, programmable low battery detect, under-voltage lockout and programmable inductor peak current. The device can be controlled by a 1nA active LOW shutdown pin.

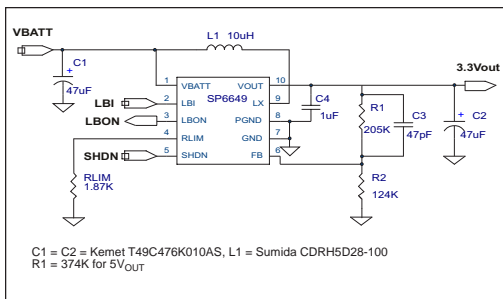

Figure 1. Typical Application Circuit



Figure 2. Maximum Load Current in Operation

ABSOLUTE MAXIMUM RATINGS

These are stress ratings only and functional operation of the device at these ratings or any other above those indicated in the operation sections of the specifications below is not implied. Exposure to absolute maximum rating conditions for extended periods of time may affect reliability.

LX, V _O , V _{BATT} , LBON, FB to GND pin	-0.3 to 6.0V
SHDN, LBI	-0.3V to V _{BATT} +0.5V
V _O , GND, LX Current	1.3A
Reverse V _{BATT} Current	220mA
Forward V _{BATT} Current	500mA
Storage Temperature	-65 °C to 150°C
Operating Temperature	-40°C to +85°C
Lead Temperature (Soldering, 10 sec)	300 °C
ESD Rating	2kV HBM

SPECIFICATIONS

V_{BATT}=V_{SHDN} = 1.3V, V_{FB}=0V, I_{LOAD} = 0mA, T_{AMB} = -40°C to +85°C, V_{OUT} = +3.3V, typical values at 27°C unless otherwise noted.

PARAMETER	MIN	TYP	MAX	UNITS	CONDITIONS
Input Voltage Operating Range, V _{BATT}	0.7		4.5	V	After Startup
Under Voltage Lock-out/UVLO		0.62		V	
Start-up Input Voltage, V _{BATT}		0.85	0.9	V	R _{LOAD} = 3k
Output Voltage, V _O	3.16	3.30	3.44	V	3.3V V _O preset
Quiescent Current into V _O , I _{QO}		12	22	µA	V _{OUT} = 3.3V, V _{FB} = 1.5V, Toggle SHDN
Quiescent Current into V _{BATT} , I _{QB}		20	500	nA	V _{OUT} = 3.3V, V _{FB} = 1.5V
Shutdown Current into V _O , I _{SDO}		1	500	nA	V _{SHDN} = 0V
Shutdown Current into V _{BATT} , I _{SDB}		200	500	nA	V _{SHDN} = 0V, V _{BATT} = 2.6V
Efficiency, R _{LIM} = 4.0K		85 91		% %	V _{BATT} = 1.3V, I _{OUT} = 50mA V _{BATT} = 2.6V, I _{OUT} = 100mA
Efficiency, R _{LIM} = 1.87K		85 92		% %	V _{BATT} = 1.3V, I _{OUT} = 100mA V _{BATT} = 2.6V, I _{OUT} = 200mA
Inductor Current Limit, I _{PK}	1.0	1.2	1.4	A	R _{LIM} = 1.17k, I _{PK} = 1400/R _{LIM}
Output Current		250 700		mA mA	V _{BATT} = 1.3V, R _{LIM} = 1.17k V _{BATT} = 2.6V, R _{LIM} = 1.17k
		150 400		mA mA	V _{BATT} = 1.3V, R _{LIM} = 1.87k V _{BATT} = 2.6V, R _{LIM} = 1.87k
Minimum Off-Time Constant K _{OFF}		1.1		V*µs	t _{OFF} K _{OFF} / (V _{OUT} - V _{BATT})
Maximum On-Time Constant K _{ON}		3.3		V*µs	t _{ON} K _{ON} / V _{BATT}
N _{MOS} Switch Resistance		0.30	0.6		I _{NMOS} = 100mA
P _{MOS} Switch Resistance		0.30	0.6		I _{PMOS} = 100mA
FB Set Voltage, V _{FB}	1.20	1.25	1.30	V	External feedback
FB Input Current		1	100	nA	V _{FB} = 1.3V
LBI Falling Trip Voltage	0.594	0.625	0.656	V	
LBI Hysteresis		25		mV	
Low Output Voltage for LBON, V _{OL}			0.4	V	V _{BATT} = 1.3V, I _{sink} = 1mA
Leakage current for LBON			500	nA	V _{BATT} = 1.3V, V _{LBON} = 3.3V
SHDN Input Voltage	V _{IL} V _{IH} V _{IL} V _{IH}	1.0 2.0	0.25 0.5	V	V _{BATT} = 1.3V V _{BATT} = 1.3V V _{BATT} = 2.6V V _{BATT} = 2.6V
SHDN Input Current		1	100	nA	

PIN DESCRIPTION

PIN NUMBER	PIN NAME	DESCRIPTION
1	V_{BATT}	Battery Voltage pin. The startup circuitry runs off of this pin. The operate circuit also uses this voltage to regulate the off-time [$t_{OFF} = K_{OFF} / (V_{OUT} - V_{BATT})$]. When the battery voltage drops below 0.62V after a successful startup the SP6649 goes into an undervoltage lockout mode (UVLO).
2	LBI	Low Battery Input pin. LBI below 0.61V causes the LBON pin to pull down to ground. Use a resistor divider to program the low voltage threshold for each battery configuration.
3	LBON	Low Battery Output Not pin. Open drain N_{MOS} output that sinks current to ground when LBI is below 0.625V.
4	R_{LIM}	Resistor Programmable Inductor Peak Current. By connecting a resistor R_{LIM} from this pin to ground the inductor peak current is set by $I_{PEAK} = 1400 / R_{LIM}$. The range for R_{LIM} is 4.0K (for 350mA) to 1.17K (for 1.2A).
5	\overline{SHDN}	Shutdown Not. Tie this pin to V_{BATT} for normal operation. Tie this pin to ground to disable all circuitry inside the chip. In shutdown the output voltage will float down to a diode drop below the battery potential.
6	FB	External Feedback pin. Connect this pin to GND for fixed +3.3V operation. Connect this pin to a resistor voltage divider between V_{OUT} and GND for adjustable output operation.
7	GND	Ground pin for the internal regulator bias currents.
8	P_{GND}	Switch ground pin. The inductor charging current flows out of this pin.
9	LX	Inductor switching node. Connect one terminal of the inductor to the positive terminal of the battery. Connect the second terminal of the inductor to this pin. The inductor charging current flows into LX, through the internal charging N-channel FET, and out the GND pin.
10	V_{OUT}	Output Voltage pin. The inductor current flows out of this pin during the off-time. It is also the internal regulator voltage supply, and minimum off-time one shot input. Kelvin connect this pin to the positive terminal of the output capacitor.

At light loads (plot A in *Figure 3*) the charge cycle will take $t_{ON,MAX}$ μ s. For a 1V battery this would be:

$$t_{ON,MAX} = K_{ON} / V_{BATT} = 3.3V\mu s / 1V = 3.3\mu s$$

The current built up in the coil during the charge cycle gets fully discharged (discontinuous conduction mode, DCM) When the current in the coil has reached zero the synchronous rectifier switch is opened and the voltage across the coil (from V_{BATT} to LX) is shorted internally to eliminate inductive ringing.

With increasing load (plot B in *Figure 3*) this inductor damping time becomes shorter (because the output will drop quicker below its regulation point due to the heavier load) up to the point where it becomes zero. If the load increases further the SP6649 enters continuous conduction mode (CCM) where there is always current in the inductor. The charge time is still $t_{ON,MAX}$ as long as the inductor peak current limit is not reached (plot C in *Figure 3*). the inductor peak current limit can be programmed by trying a resistor R_{LIM} from the R_{LIM} pin to ground where:

$$I_{PEAK} = 1400 / R_{LIM}$$

with a maximum recommended I_{PEAK} of 1.2A (or a minimum R_{LIM} of 1.17K).

When the peak current limit is reached the charge time is short-cycled.

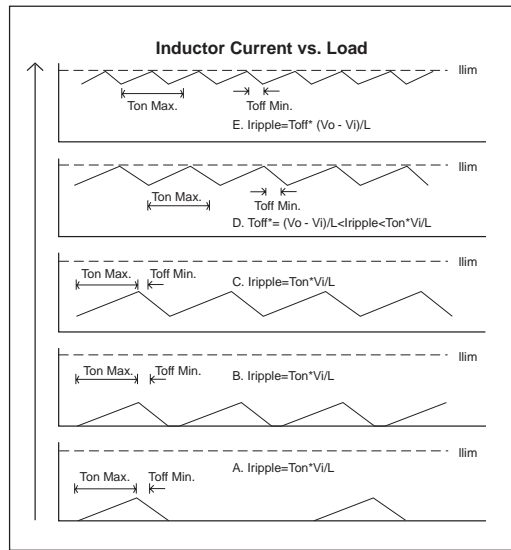

Figure 3. Inductor Current vs. Load

In (plot D of *Figure 3*) the current reaches the peak current limit during the charge cycle but full load is still not reached because at the end of the minimum off-time V_{OUT} was still not below its regulation point. Finally in plot E the maximum load is reached where the discharge time has shrunk to its minimum allowed value $t_{OFF,MIN}$.

PERFORMANCE CHARACTERISTICS

3.3V out, refer to the Circuit in Figure 1, $T_{AMB}=+25^{\circ}\text{C}$.

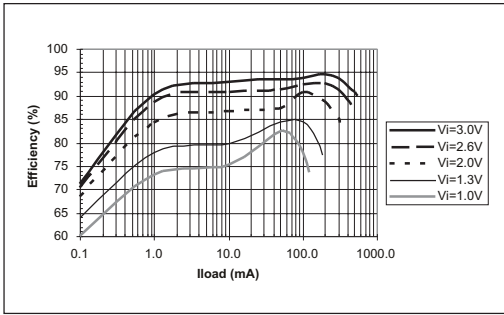

Figure 4. Efficiency vs. Load Current

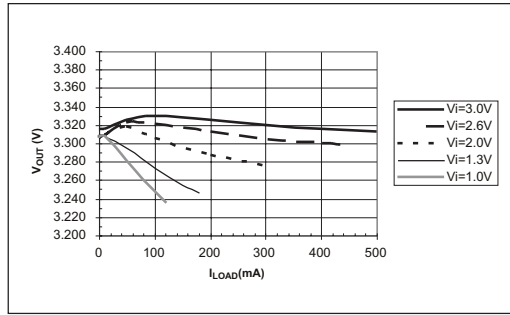

Figure 5. Line/Load Rejection vs. Load Current

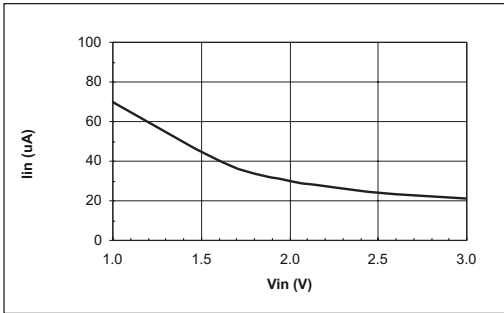

Figure 6. No Load Battery Current

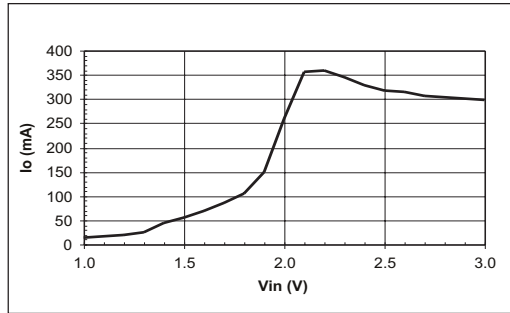

Figure 7. Maximum Resistive Load Current in Startup

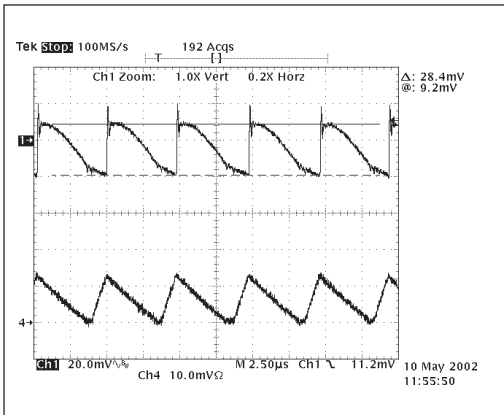

Figure 8. Output Ripple, $V_{IN}=2.6\text{V}$, $I_{LOAD}=80\text{mA}$

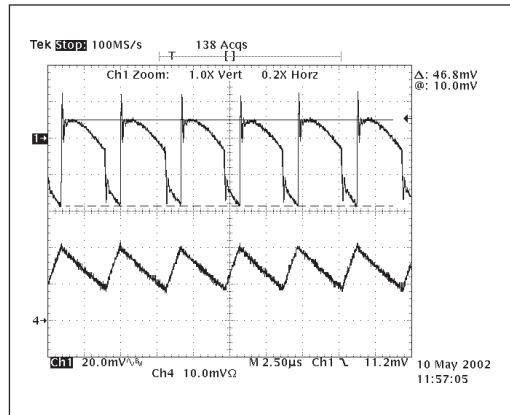

Figure 9. Output Ripple, $V_{IN}=2.6\text{V}$, $I_{LOAD}=200\text{mA}$

PERFORMANCE CHARACTERISTICS

5V out, refer to the Circuit in Figure 1, $T_{AMB}=+25^{\circ}\text{C}$, $R_1=374\text{K}$.

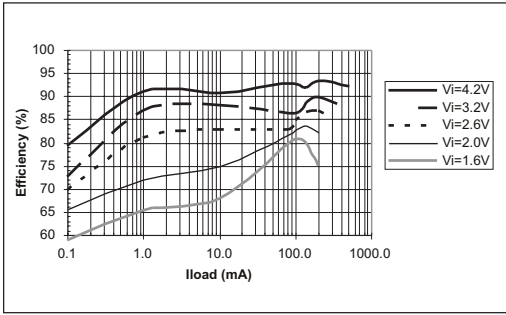

Figure 10. SP6649 5V Efficiency vs. Load Current

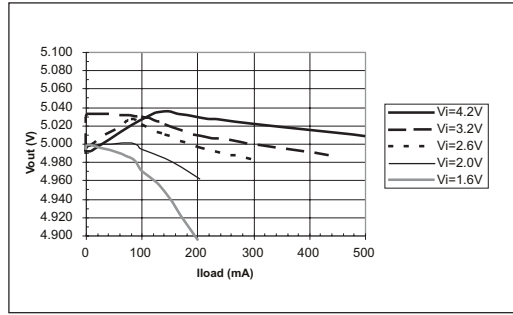

Figure 11. SP6649 5V Line/Load Rejection vs. Load Current

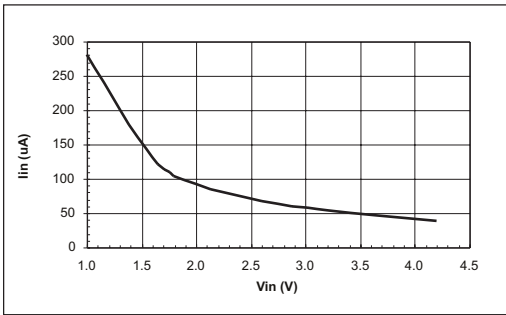

Figure 12. SP6649 5V No Load Battery Current

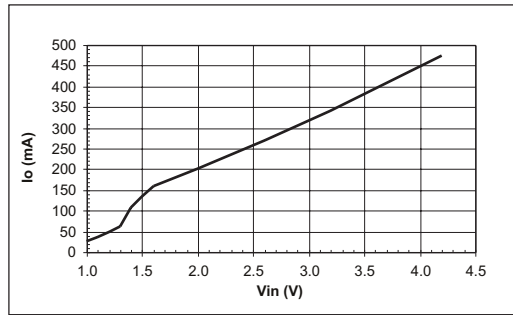

Figure 13. SP6649 5V Maximum Resistive Load Current in Startup

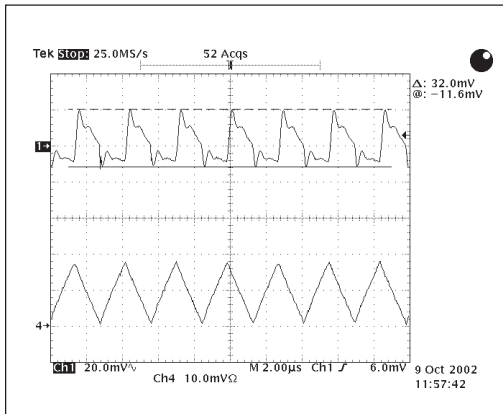

Figure 14. SP6649 5V Output Ripple, $V_{in}=2.6\text{V}$, $I_{load}=80\text{mA}$

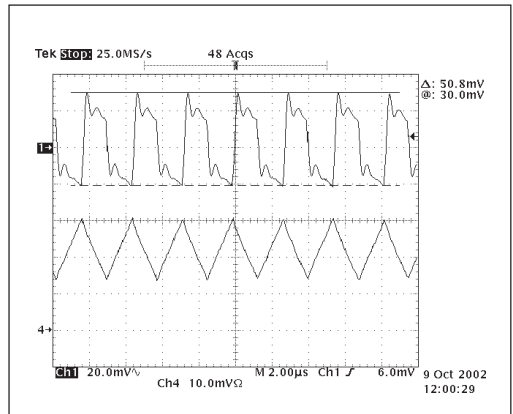
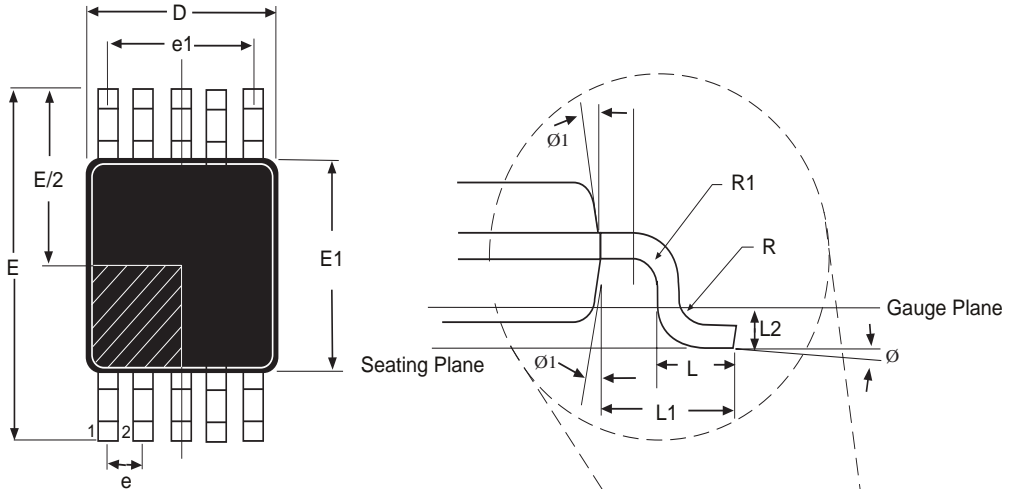

Figure 15. SP6649 5V Output Ripple, $V_{in}=2.6\text{V}$, $I_{load}=200\text{mA}$

ADVANCED INFORMATION

PACKAGE: 10-PIN MSOP

(ALL DIMENSIONS IN MILLIMETERS)



Pin #1 identifier must be indicated within this shaded area ($D/2 * E/2$)

Dimensions in (mm)	10-PIN MSOP JEDEC MO-187 (BA) Variation		
	MIN	NOM	MAX
A	-	-	1.1
A1	0	-	0.15
A2	0.75	0.85	0.95
b	0.17	-	0.27
c	0.08	-	0.23
D	3.00 BSC		
E	4.90 BSC		
E1	3.00 BSC		
e	0.50 BSC		
e1	2.00 BSC		
L	0.4	0.60	0.80
L1	-	0.95	-
L2	-	0.25	-
N	-	10	-
R	0.07	-	-
R1	0.07	-	-
Ø	0°	-	8°
Ø1	0°	-	15°

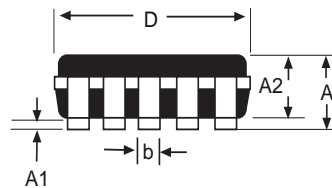
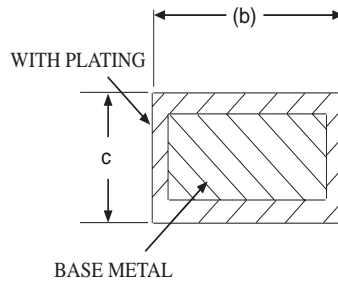

ORDERING INFORMATION

Part Number	Operating Temperature Range	Package Type
SP6649EU	-40°C to +85°C	10 Pin MSOP
SP6649EU/TR	-40°C to +85°C	(Tape & Reel) 10 Pin MSOP

ADVANCED INFORMATION



SIGNAL PROCESSING EXCELLENCE

Sipex Corporation

Headquarters and Sales Office
233 South Hillview Drive
Milpitas, CA 95035
TEL: (408) 934-7500
FAX: (408) 935-7600

Sales Office
22 Linnell Circle
Billerica, MA 01821
TEL: (978) 667-8700
FAX: (978) 670-9001
e-mail: sales@sipex.com

Sipex Corporation reserves the right to make changes to any products described herein. Sipex does not assume any liability arising out of the application or use of any product or circuit described herein; neither does it convey any license under its patent rights nor the rights of others.