

18 - 20 GHz 5-Bit Phase Shifter

TGP1439-EPU

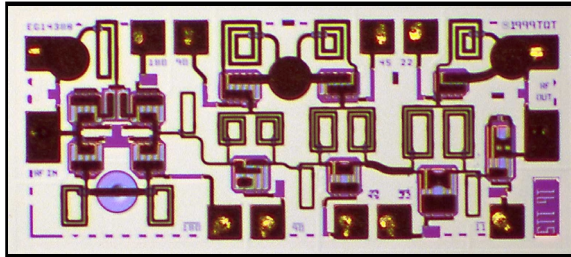

The TriQuint TGP1439-EPU is a 5-Bit Digital Phase Shifter MMIC design using TriQuint's proven 0.5 μm Power pHEMT process to support a variety of K-Band phased array applications including satellite communication systems.

The 5-bit design utilizes a compact topology that achieves a 1.27 mm² die area, high performance and good tolerance to control voltage variation

The TGP1439-EPU provides a 5-Bit digital phase shift function with a nominal -5 dB insertion loss and 3° RMS phase shift error over a bandwidth of 18-20 GHz.

The TGP1439-EPU requires a minimum of off-chip components and operates with a -5.0 V to -2.5 V control voltage range. Each device is RF tested on-wafer to ensure performance compliance. The device is available in chip form.

Key Features and Performance

- 0.5um pHEMT Technology
- 18-20 GHz Frequency Range
- 3° Typical RMS Phase Shift Error
- -5 dB Typical Insertion Loss
- Control Voltage: -2.5 V to -5.0 V
- Compact 1.27 mm² Die Area

Primary Applications

- Phased Arrays
- Satellite Communication Systems

TGP1439-EPU Typical RF Performance (Fixtured)

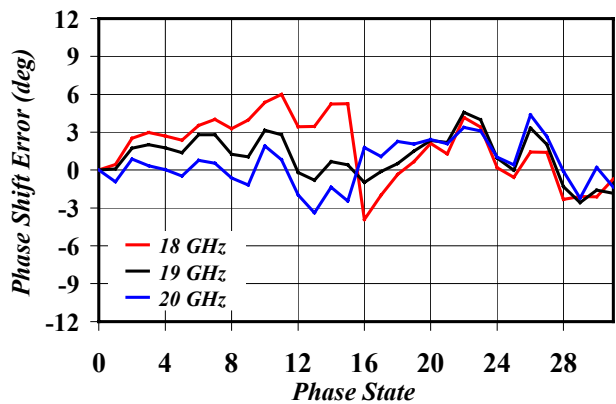

TGP1439-EPU Typical RF Performance (Fixtured)

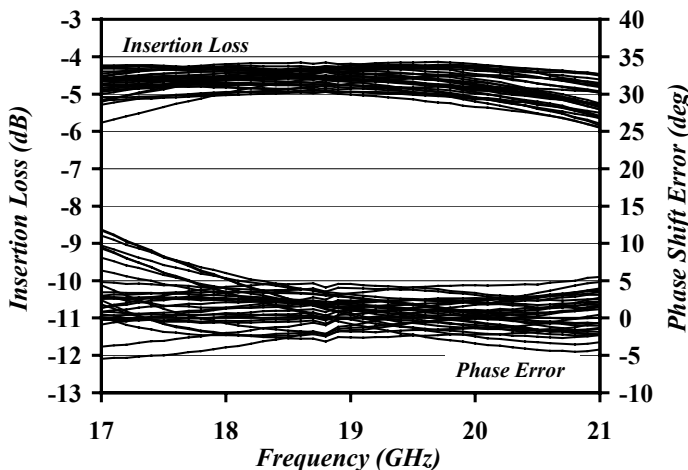

TGP1439-EPU Typical RF Performance (Fixtured)

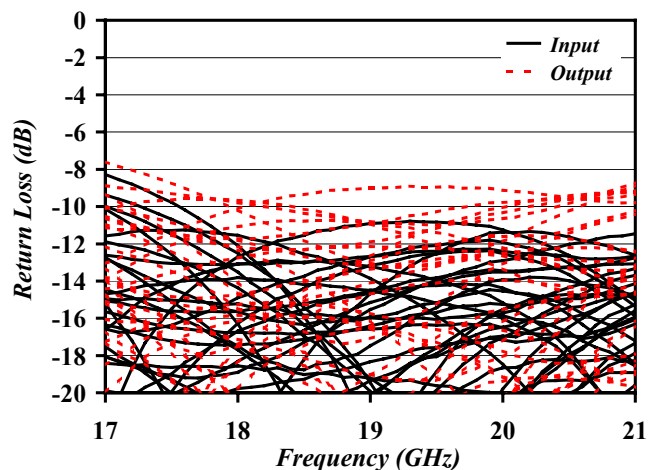

Note: Devices designated as EPU are typically early in their characterization process prior to finalizing all electrical and process specifications. Specifications are subject to change without notice.

Electrical Characteristics
RECOMMENDED MAXIMUM RATINGS

Symbol	Parameter	Value	Notes
V ⁻	Control Voltage	-8 V	
I ⁺	Control Current	1 mA	<u>3/</u>
P _D	Power Dissipation	0.1 W	
P _{IN}	Input Continuous Wave Power	20 dBm	
T _{CH}	Operating Channel Temperature	150 °C	<u>1/</u> , <u>2/</u>
T _M	Mounting Temperature (30 seconds)	320 °C	
T _{STG}	Storage Temperature	-65 °C to 150 °C	

- 1/ These ratings apply to each individual FET
- 2/ Junction operating temperature will directly affect the device mean time to failure (MTTF). For maximum life it is recommended that junction temperatures be maintained at the lowest possible levels.
- 3/ Total current for the entire MMIC

ON-WAFER RF PROBE CHARACTERISTICS
(T_A = 25 °C ± 5°C)

Symbol	Parameter	Test Condition V _{ctrl} =0V / -2.5V	Limit			Units
			Min	Nom	Max	
IL	Insertion Loss	F = 18, 19, 20 GHz States 0 and 31	-5.5	-4.6	-4.0	dB
IRL	Input Return Loss	F = 18, 19, 20 GHz States 0 and 31		-16	-11	dB
ORL	Output Return Loss	F = 18, 19, 20 GHz States 0 and 31		-14	-11	dB
PS	Phase Shift	F = 18, 19, 20 GHz State 31	342	344	350	deg

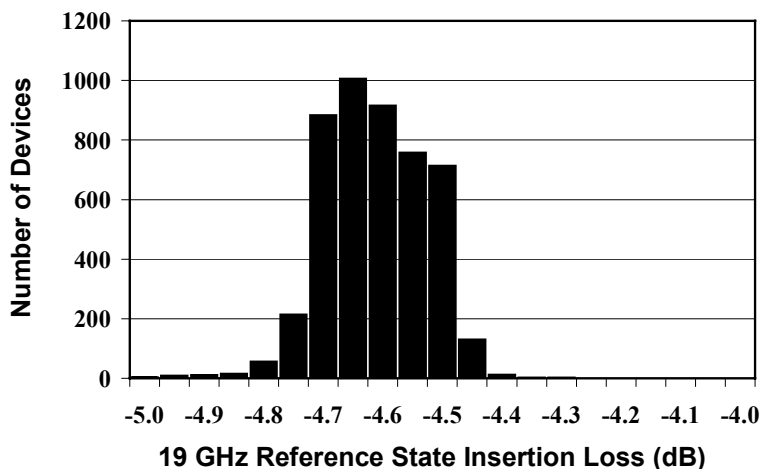

Note: Devices designated as EPU are typically early in their characterization process prior to finalizing all electrical and process specifications. Specifications are subject to change without notice.

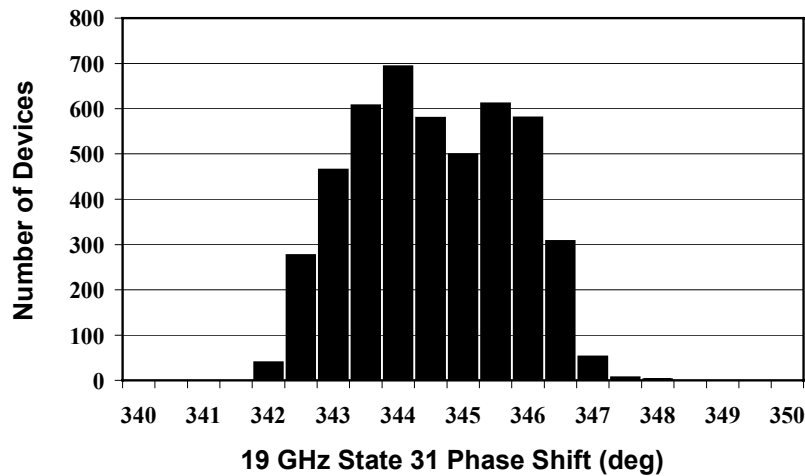
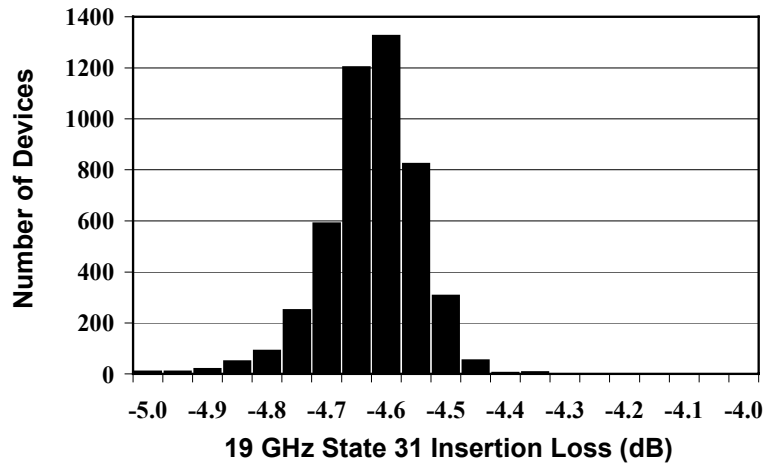

Typical Fixtured Performance Over the 18-20 GHz Band

Parameter	Unit	-5.0 V	-2.5 V
Mean Insertion Loss	dB	-4.9	-5.0
Mean Loss Flatness	dB	0.3	0.6
Peak Amplitude Error	dBpp	1.2	1.3
RMS Amplitude Error	dB	0.25	0.30
Peak Phase Shift Error	deg	-3 / +7	-3 / +7
RMS Phase Shift Error	deg	3.0	2.7
Loss Temp. Variation	dB/°C	-0.0048	-0.0052
Ave Input Return Loss	dB	-16	-15
Ave Output Return Loss	dB	-15	-15

Note: Devices designated as EPU are typically early in their characterization process prior to finalizing all electrical and process specifications. Specifications are subject to change without notice.

Mechanical Characteristics

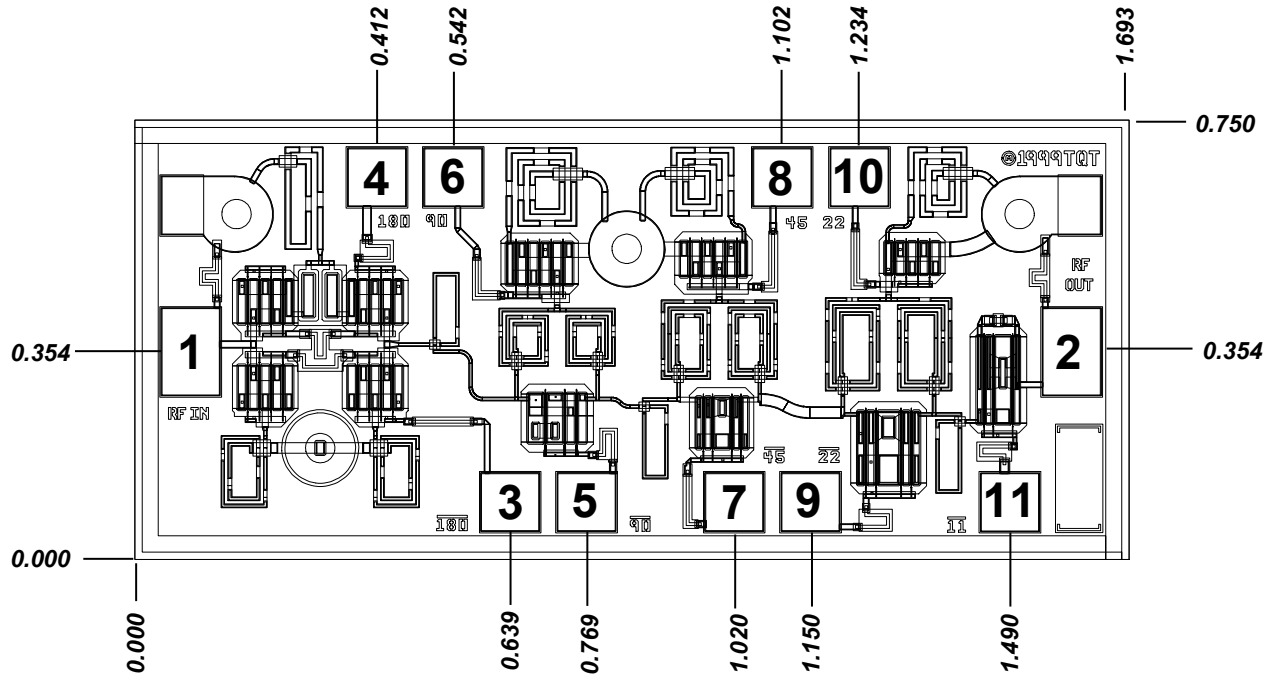

Units: millimeters

Thickness: 0.1016

Chip size tolerance: +/- 0.0508

V_{cntl} = -5.0 V to -2.5 V

Passive device, RF IN and RF OUT designators for reference only

Bond Pad #1	(RF IN)	0.100 x 0.150
Bond Pad #2	(RF OUT)	0.100 x 0.150
Bond Pad #3	(180° Bit ON: V= V_{cntl})	0.100 x 0.100
Bond Pad #4	(180° Bit ON: V= 0.0V)	0.100 x 0.100
Bond Pad #5	(90° Bit ON: V= V_{cntl})	0.100 x 0.100
Bond Pad #6	(90° Bit ON: V= 0.0V)	0.100 x 0.100
Bond Pad #7	(45° Bit ON: V= V_{cntl})	0.100 x 0.100
Bond Pad #8	(45° Bit ON: V= 0.0V)	0.100 x 0.100
Bond Pad #9	(22.5° Bit ON: V= V_{cntl})	0.100 x 0.100
Bond Pad #10	(22.5° Bit ON: V= 0.0V)	0.100 x 0.100
Bond Pad #11	(11.25° Bit ON: V= V_{cntl})	0.100 x 0.100

Note: To turn phase bits off, apply the opposite condition. For example to turn Phase bit 180° OFF, Bond Pad 3 = 0.0V and Bond Pad 4 = V_{cntl}.

Note: Devices designated as EPU are typically early in their characterization process prior to finalizing all electrical and process specifications. Specifications are subject to change without notice.

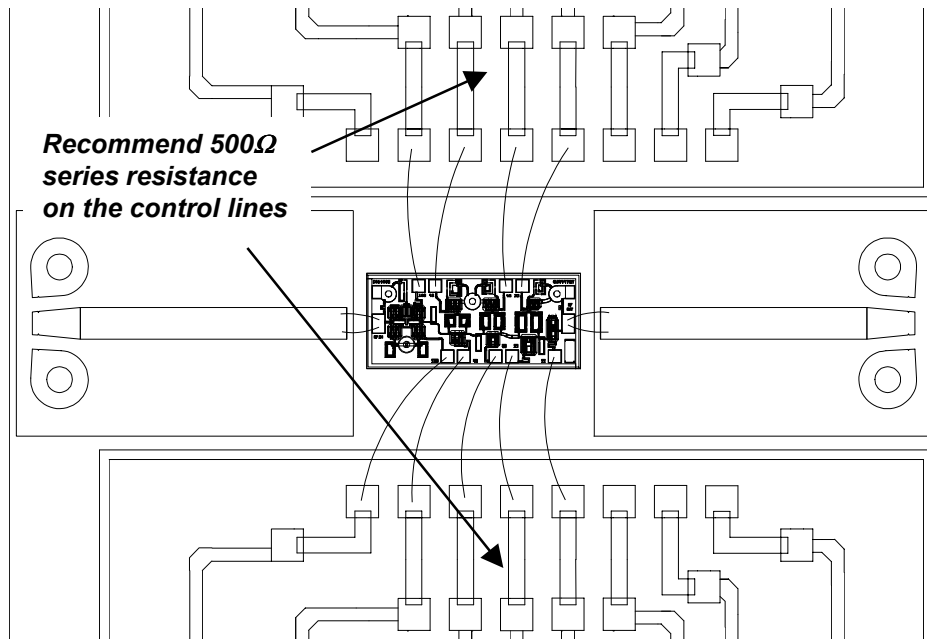

Chip Assembly and Bonding Diagram

Reflow process assembly notes:

- AuSn (80/20) solder with limited exposure to temperatures at or above 300°C
- alloy station or conveyor furnace with reducing atmosphere
- no fluxes should be utilized
- coefficient of thermal expansion matching is critical for long-term reliability
- storage in dry nitrogen atmosphere

Component placement and adhesive attachment assembly notes:

- vacuum pencils and/or vacuum collets preferred method of pick up
- avoidance of air bridges during placement
- force impact critical during auto placement
- organic attachment can be used in low-power applications
- curing should be done in a convection oven; proper exhaust is a safety concern
- microwave or radiant curing should not be used because of differential heating
- coefficient of thermal expansion matching is critical

Interconnect process assembly notes:

- thermosonic ball bonding is the preferred interconnect technique
- force, time, and ultrasonics are critical parameters
- aluminum wire should not be used
- discrete FET devices with small pad sizes should be bonded with 0.0007-inch wire
- maximum stage temperature: 200°C

GaAs MMIC devices are susceptible to damage from Electrostatic Discharge. Proper precautions should be observed during handling, assembly and test.