

Triacs

Silicon Bidirectional Triode Thyristors

... designed primarily for full-wave ac control applications, such as light dimmers, motor controls, heating controls and power supplies; or wherever full-wave silicon gate controlled solid-state devices are needed. Triac type thyristors switch from a blocking to a conducting state for either polarity of applied anode voltage with positive or negative gate triggering.

- Blocking Voltage to 800 Volts
- All Diffused and Glass Passivated Junctions for Greater Parameter Uniformity and Stability
- Small, Rugged, Thermowatt Construction for Low Thermal Resistance, High Heat Dissipation and Durability
- Gate Triggering Guaranteed in Two Modes (2N6342, 2N6343, 2N6344, 2N6345) or Four Modes (2N6346, 2N6347, 2N6348, 2N6349)
- For 400 Hz Operation, Consult Factory
- 12 Ampere Devices Available as 2N6342A thru 2N6349A

**2N6342
thru
2N6349**

**TRIACs
8 AMPERES RMS
200 thru 800 VOLTS**

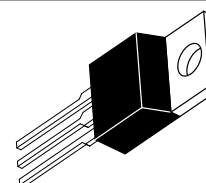
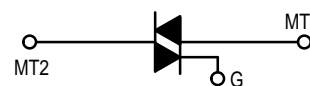

**CASE 221A-04
(TO-220AB)
STYLE 4**

MAXIMUM RATINGS ($T_J = 25^\circ\text{C}$ unless otherwise noted.)

Rating	Symbol	Value	Unit
*Peak Repetitive Off-State Voltage ⁽¹⁾ (Gate Open, $T_J = -40$ to $+110^\circ\text{C}$) 1/2 Sine Wave 50 to 60 Hz, Gate Open	V_{DRM}	200 400 600 800	Volts
*RMS On-State Current Full Cycle Sine Wave 50 to 60 Hz	$I_T(\text{RMS})$	8 4	Amps
*Peak Non-repetitive Surge Current (One Full Cycle, 60 Hz, $T_C = +80^\circ\text{C}$) Preceded and followed by Rated Current	I_{TSM}	100	Amps
Circuit Fusing ($t = 8.3$ ms)	I^2t	40	A^2s
*Peak Gate Power ($T_C = +80^\circ\text{C}$, Pulse Width = 2 μs)	P_{GM}	20	Watts
*Average Gate Power ($T_C = +80^\circ\text{C}$, $t = 8.3$ ms)	$P_{G(AV)}$	0.5	Watt
*Peak Gate Current	I_{GM}	2	Amps
*Peak Gate Voltage	V_{GM}	10	Volts
*Operating Junction Temperature Range	T_J	-40 to +125	$^\circ\text{C}$
*Storage Temperature Range	T_{stg}	-40 to +150	$^\circ\text{C}$

1. V_{DRM} for all types can be applied on a continuous basis. Blocking voltages shall not be tested with a constant current source such that the voltage ratings of the devices are exceeded.

REV 1

2N6342 thru 2N6349

THERMAL CHARACTERISTICS

Characteristic	Symbol	Max	Unit
*Thermal Resistance, Junction to Case	$R_{\theta JC}$	2.2	$^{\circ}\text{C}/\text{W}$

ELECTRICAL CHARACTERISTICS ($T_C = 25^{\circ}\text{C}$, and Either Polarity of MT2 to MT1 Voltage, unless otherwise noted.)

Characteristic	Symbol	Min	Typ	Max	Unit
*Peak Blocking Current ($V_D = \text{Rated } V_{DRM}$, gate open) $T_J = 25^{\circ}\text{C}$ $T_J = 100^{\circ}\text{C}$	I_{DRM}	—	—	10 2	μA mA
*Peak On-State Voltage ($I_{TM} = 11 \text{ A Peak}$; Pulse Width = 1 to 2 ms, Duty Cycle $\leq 2\%$)	V_{TM}	—	1.3	1.55	Volts
Gate Trigger Current (Continuous dc) ($V_D = 12 \text{ Vdc}$, $R_L = 100 \text{ Ohms}$) (Minimum Gate Pulse Width = 2 μs) MT2(+), G(+) All Types MT2(+), G(-) 2N6346 thru 49 MT2(-), G(-) All Types MT2(-), G(+) 2N6346 thru 49 *MT2(+), G(+); MT2(-), G(-) $T_C = -40^{\circ}\text{C}$ All Types *MT2(+), G(-); MT2(-), G(+) $T_C = -40^{\circ}\text{C}$ 2N6346 thru 49	I_{GT}	—	12 12 20 35 — —	50 75 50 75 100 125	mA
Gate Trigger Voltage (Continuous dc) ($V_D = 12 \text{ Vdc}$, $R_L = 100 \text{ Ohms}$) (Minimum Gate Pulse Width = 2 μs) MT2(+), G(+) All Types MT2(+), G(-) 2N6346 thru 49 MT2(-), G(-) All Types MT2(-), G(+) 2N6346 thru 49 *MT2(+), G(+); MT2(-), G(-) $T_C = -40^{\circ}\text{C}$ All Types *MT2(+), G(-); MT2(-), G(+) $T_C = -40^{\circ}\text{C}$ 2N6346 thru 49 ($V_D = \text{Rated } V_{DRM}$, $R_L = 10 \text{ k Ohms}$, $T_J = 100^{\circ}\text{C}$) *MT2(+), G(+); MT2(-), G(-) All Types *MT2(+), G(-); MT2(-), G(-) 2N6346 thru 49	V_{GT}	—	0.9 0.9 1.1 1.4 — —	2 2.5 2 2.5 2.5 3	Volts
*Holding Current ($V_D = 12 \text{ Vdc}$, Gate Open) $T_C = 25^{\circ}\text{C}$ ($I_T = 200 \text{ mA}$) $*T_C = -40^{\circ}\text{C}$	I_H	—	6 —	40 75	mA
*Turn-On Time ($V_D = \text{Rated } V_{DRM}$, $I_{TM} = 11 \text{ A}$, $I_{GT} = 120 \text{ mA}$, Rise Time = 0.1 μs , Pulse Width = 2 μs)	t_{gt}	—	1.5	2	μs
Critical Rate of Rise of Commutation Voltage ($V_D = \text{Rated } V_{DRM}$, $I_{TM} = 11 \text{ A}$, Commutating $di/dt = 4.0 \text{ A/ms}$, Gate Unenergized, $T_C = 80^{\circ}\text{C}$)	$dv/dt(c)$	—	5	—	$\text{V}/\mu\text{s}$

*Indicates JEDEC Registered Data.

FIGURE 1 – RMS CURRENT DERATING

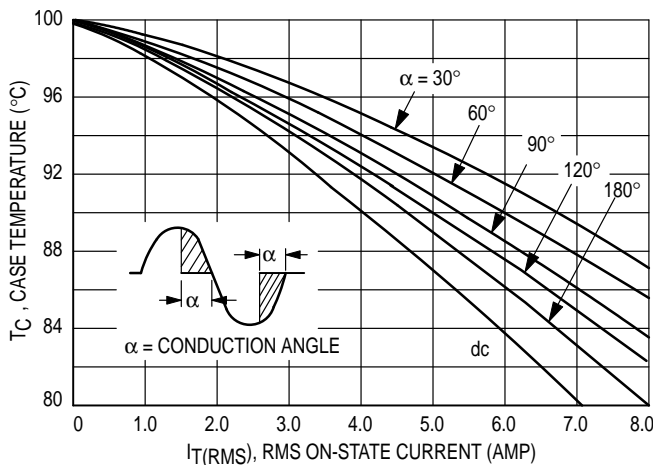

FIGURE 2 – ON-STATE POWER DISSIPATION

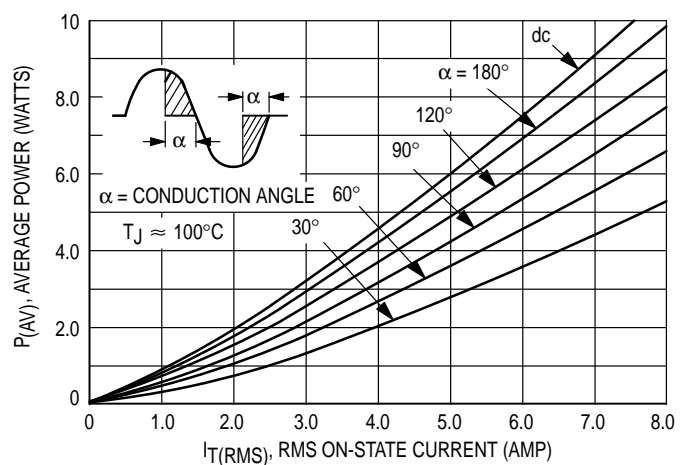

FIGURE 3 – TYPICAL GATE TRIGGER VOLTAGE

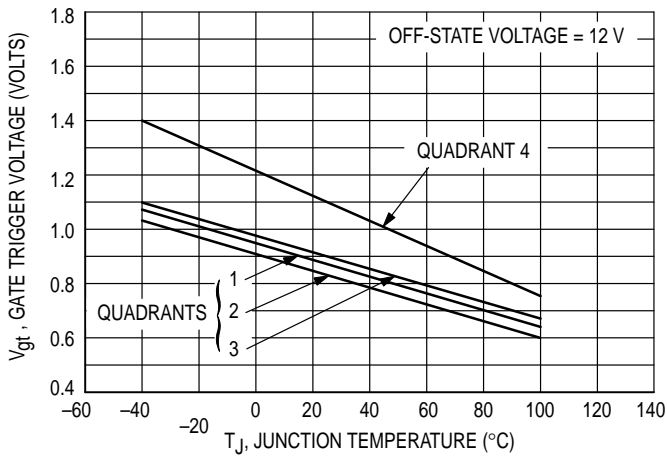

FIGURE 4 – TYPICAL GATE TRIGGER CURRENT

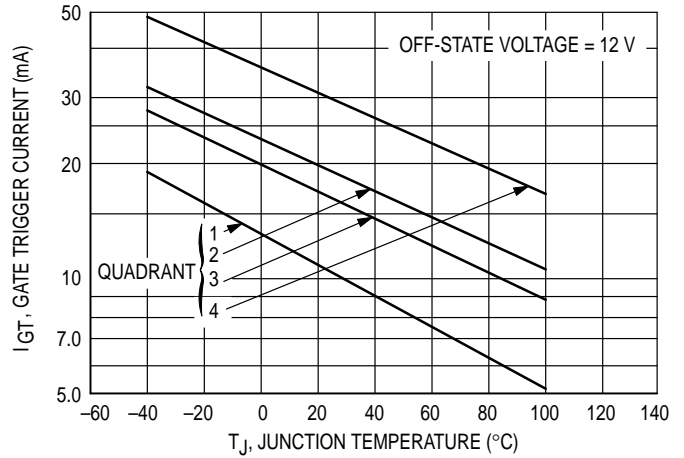

FIGURE 5 – ON-STATE CHARACTERISTICS

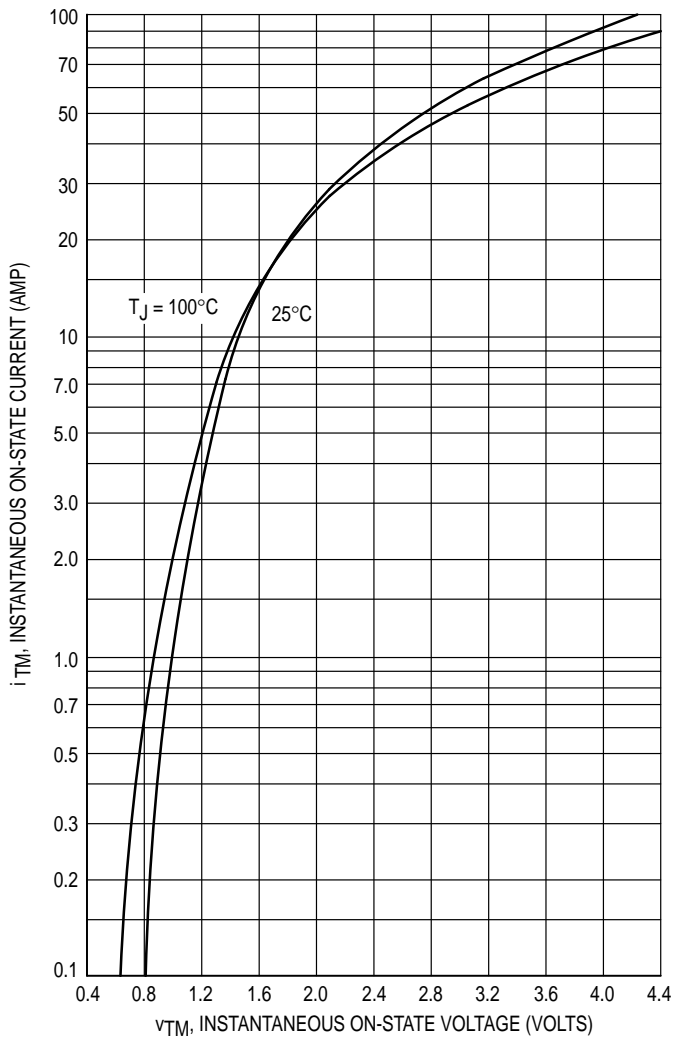

FIGURE 6 – TYPICAL HOLDING CURRENT

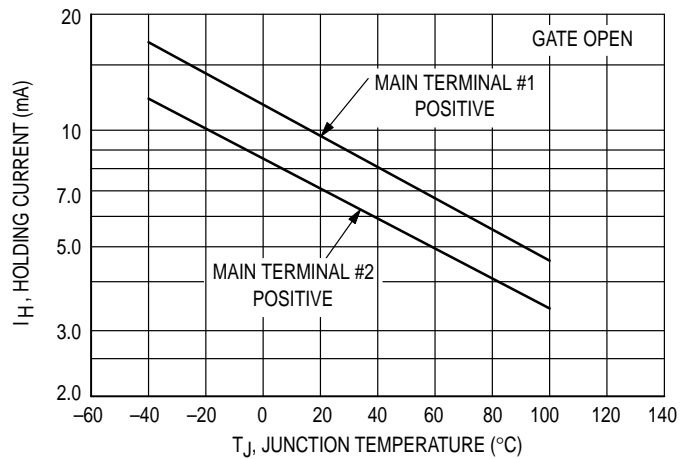

FIGURE 7 – MAXIMUM NON-REPETITIVE SURGE CURRENT

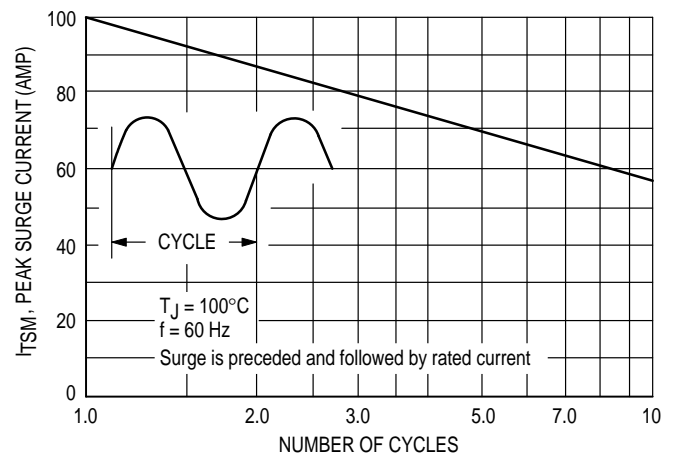
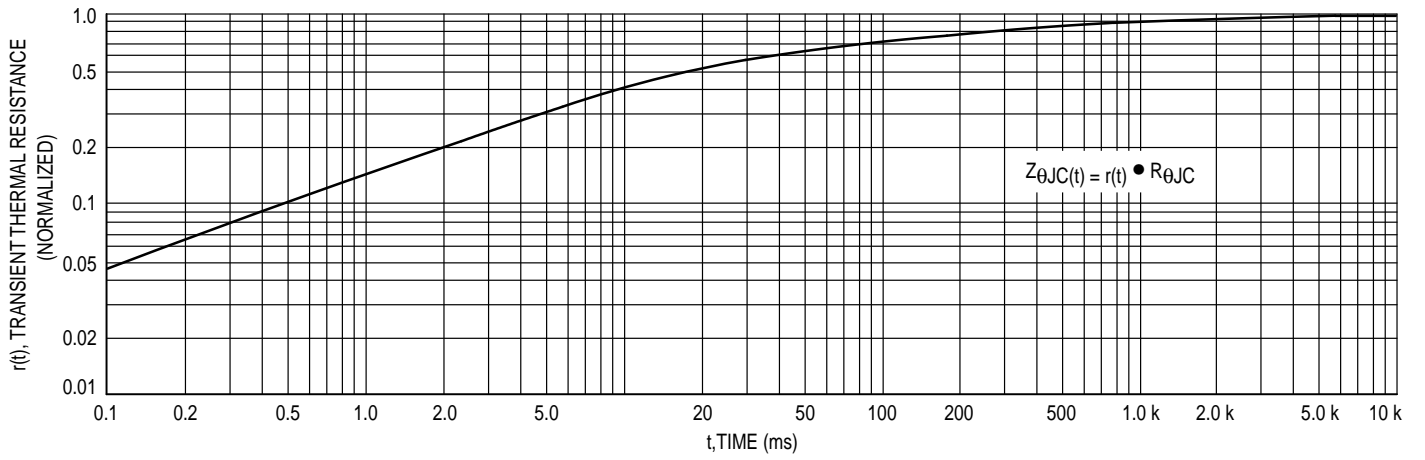
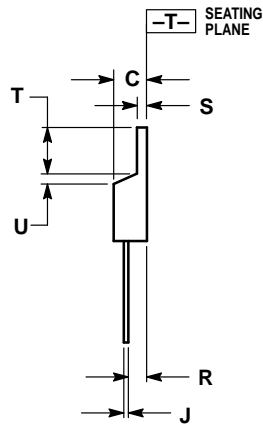
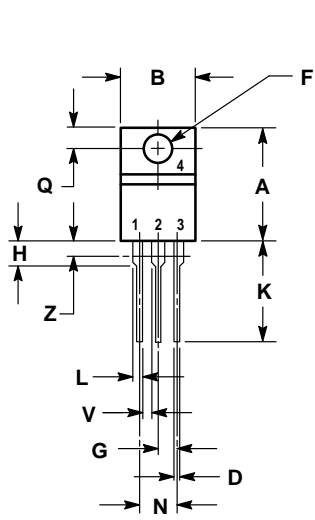

FIGURE 8 – TYPICAL THERMAL RESPONSE



PACKAGE DIMENSIONS



STYLE 4:
 PIN 1. MAIN TERMINAL 1
 2. MAIN TERMINAL 2
 3. GATE
 4. MAIN TERMINAL 2

- NOTES:
 1. DIMENSIONING AND TOLERANCING PER ANSI Y14.5M, 1982.
 2. CONTROLLING DIMENSION: INCH.
 3. DIMENSION Z DEFINES A ZONE WHERE ALL BODY AND LEAD IRREGULARITIES ARE ALLOWED.

DIM	INCHES		MILLIMETERS	
	MIN	MAX	MIN	MAX
A	0.570	0.620	14.48	15.75
B	0.380	0.405	9.66	10.28
C	0.160	0.190	4.07	4.82
D	0.025	0.035	0.64	0.88
F	0.142	0.147	3.61	3.73
G	0.095	0.105	2.42	2.66
H	0.110	0.155	2.80	3.93
J	0.014	0.022	0.36	0.55
K	0.500	0.562	12.70	14.27
L	0.045	0.055	1.15	1.39
N	0.190	0.210	4.83	5.33
Q	0.100	0.120	2.54	3.04
R	0.080	0.110	2.04	2.79
S	0.045	0.055	1.15	1.39
T	0.235	0.255	5.97	6.47
U	0.000	0.050	0.00	1.27
V	0.045	—	1.15	—
Z	—	0.080	—	2.04

CASE 221A-04
 (TO-220AB)

Motorola reserves the right to make changes without further notice to any products herein. Motorola makes no warranty, representation or guarantee regarding the suitability of its products for any particular purpose, nor does Motorola assume any liability arising out of the application or use of any product or circuit, and specifically disclaims any and all liability, including without limitation consequential or incidental damages. "Typical" parameters can and do vary in different applications. All operating parameters, including "Typicals" must be validated for each customer application by customer's technical experts. Motorola does not convey any license under its patent rights nor the rights of others. Motorola products are not designed, intended, or authorized for use as components in systems intended for surgical implant into the body, or other applications intended to support or sustain life, or for any other application in which the failure of the Motorola product could create a situation where personal injury or death may occur. Should Buyer purchase or use Motorola products for any such unintended or unauthorized application, Buyer shall indemnify and hold Motorola and its officers, employees, subsidiaries, affiliates, and distributors harmless against all claims, costs, damages, and expenses, and reasonable attorney fees arising out of, directly or indirectly, any claim of personal injury or death associated with such unintended or unauthorized use, even if such claim alleges that Motorola was negligent regarding the design or manufacture of the part. Motorola and [®] are registered trademarks of Motorola, Inc. Motorola, Inc. is an Equal Opportunity/Affirmative Action Employer.

Literature Distribution Centers:

USA: Motorola Literature Distribution; P.O. Box 20912; Phoenix, Arizona 85036.

EUROPE: Motorola Ltd.; European Literature Centre; 88 Tanners Drive, Blakelands, Milton Keynes, MK14 5BP, England.

JAPAN: Nippon Motorola Ltd.; 4-32-1, Nishi-Gotanda, Shinagawa-ku, Tokyo 141, Japan.

ASIA PACIFIC: Motorola Semiconductors H.K. Ltd.; Silicon Harbour Center, No. 2 Dai King Street, Tai Po Industrial Estate, Tai Po, N.T., Hong Kong.



This datasheet has been download from:

www.datasheetcatalog.com

Datasheets for electronics components.