

IRF420, IRF421, IRF422, IRF423

2.2A and 2.5A, 450V and 500V, 3.0 and 4.0 Ohm,
N-Channel Power MOSFETs

July 1998

Features

- 2.2A and 2.5A, 450V and 500V
- $r_{DS(ON)} = 3.0\Omega$ and 4.0Ω
- SOA is Power Dissipation Limited
- Nanosecond Switching Speeds
- Linear Transfer Characteristics
- High Input Impedance
- Majority Carrier Device
- Related Literature
 - TB334 "Guidelines for Soldering Surface Mount Components to PC Boards"

Ordering Information

PART NUMBER	PACKAGE	BRAND
IRF420	TO-204AA	IRF420
IRF421	TO-204AA	IRF421
IRF422	TO-204AA	IRF422
IRF423	TO-204AA	IRF423

NOTE: When ordering, use the entire part number.

Description

These are N-Channel enhancement mode silicon gate power field effect transistors. They are advanced power MOSFETs designed, tested, and guaranteed to withstand a specified level of energy in the breakdown avalanche mode of operation. All of these power MOSFETs are designed for applications such as switching regulators, switching converters, motor drivers, relay drivers, and drivers for high power bipolar switching transistors requiring high speed and low gate drive power. These types can be operated directly from integrated circuits.

Formerly developmental type TA17405.

Symbol

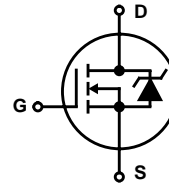

Packaging

JEDEC TO-204AA

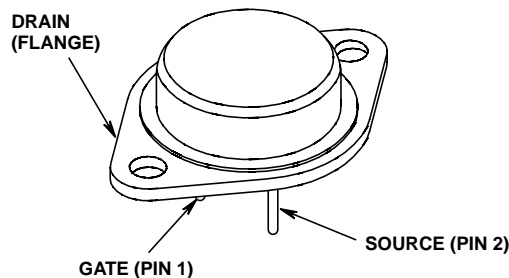

IRF420, IRF421, IRF422, IRF423

Absolute Maximum Ratings $T_C = 25^\circ\text{C}$ Unless Otherwise Specified

	IRF420	IRF421	IRF422	IRF423	UNITS
Drain to Source Breakdown Voltage (Note 1) V_{DS}	500	450	500	450	V
Drain to Gate Voltage ($R_{GS} = 20\text{k}\Omega$) (Note 1) V_{DGR}	500	450	500	450	V
Continuous Drain Current I_D	2.5	2.5	2.2	2.2	A
$T_C = 100^\circ\text{C}$ I_D	1.6	1.6	1.4	1.4	A
Pulsed Drain Current (Note 3) I_{DM}	10	10	8	8	A
Gate to Source Voltage V_{GS}	± 20	± 20	± 20	± 20	V
Maximum Power Dissipation P_D	50	50	50	50	W
Linear Derating Factor	0.4	0.4	0.4	0.4	$\text{W}/^\circ\text{C}$
Single Pulse Avalanche Energy Rating (Note 4) E_{AS}	210	210	210	210	mJ
Operating and Storage Temperature T_J, T_{STG}	-55 to 150	-55 to 150	-55 to 150	-55 to 150	$^\circ\text{C}$
Maximum Temperature for Soldering					
Leads at 0.063in (1.6mm) from Case for 10s T_L	300	300	300	300	$^\circ\text{C}$
Package Body for 10s, See TB334 T_{pkg}	260	260	260	260	$^\circ\text{C}$

CAUTION: Stresses above those listed in "Absolute Maximum Ratings" may cause permanent damage to the device. This is a stress only rating and operation of the device at these or any other conditions above those indicated in the operational sections of this specification is not implied.

NOTE:

- $T_J = 25^\circ\text{C}$ to 125°C .

Electrical Specifications $T_C = 25^\circ\text{C}$, Unless Otherwise Specified

PARAMETER	SYMBOL	TEST CONDITIONS	MIN	TYP	MAX	UNITS
Drain to Source Breakdown Voltage IRF420, IRF422	BV_{DSS}	$I_D = 250\mu\text{A}, V_{GS} = 0\text{V}$, (Figure 10)	500	-	-	V
IRF421, IRF423			450	-	-	V
Gate Threshold Voltage	$V_{GS(TH)}$	$V_{GS} = V_{DS}, I_D = 250\mu\text{A}$	2.0	-	4.0	V
Zero Gate Voltage Drain Current	I_{DSS}	$V_{DS} = \text{Rated } BV_{DSS}, V_{GS} = 0\text{V}$	-	-	25	μA
		$V_{DS} = 0.8 \times \text{Rated } BV_{DSS}, V_{GS} = 0\text{V}, T_J = 125^\circ\text{C}$	-	-	250	μA
On-State Drain Current (Note 2) IRF420, IRF421	$I_{D(ON)}$	$V_{DS} > I_{D(ON)} \times r_{DS(ON)MAX}, V_{GS} = 10\text{V}$ (Figure 7)	2.5	-	-	A
IRF422, IRF423			2.2	-	-	A
Gate to Source Leakage Current	I_{GSS}	$V_{GS} = \pm 20\text{V}$	-	-	± 100	nA
Drain to Source On Resistance (Note 2) IRF420, IRF421	$r_{DS(ON)}$	$I_D = 1.4\text{A}, V_{GS} = 10\text{V}$, (Figures 8, 9)	-	2.5	3.0	Ω
IRF422, IRF423			-	3.0	4.0	Ω
Forward Transconductance (Note 2)	g_{fs}	$V_{DS} \geq 10\text{V}, I_D = 2.0\text{A}$, (Figure 12)	1.5	2.3	-	S
Turn-On Delay Time	$t_{d(ON)}$	$V_{DD} = 250\text{V}, I_D \approx 2.5\text{A}, R_G = 18\Omega, R_L = 96\Omega, V_{GS} = 10\text{V}$, (Figures 17, 18) MOSFET Switching Times are Essentially Independent of Operating Temperature	-	10	15	ns
Rise Time	t_r		-	12	18	ns
Turn-Off Delay Time	$t_{d(OFF)}$		-	28	42	ns
Fall Time	t_f		-	12	18	ns
Total Gate Charge (Gate to Source + Gate to Drain)	$Q_{g(TOT)}$		$V_{GS} = 10\text{V}, I_D \approx 2.5\text{A}, V_{DS} = 0.8 \times \text{Rated } BV_{DSS}, I_{G(REF)} = 1.5\text{mA}$, (Figures 14, 19, 20) Gate Charge is Essentially Independent of Operating Temperature	-	11	19
Gate to Source Charge	Q_{gs}		-	5	-	nC
Gate to Drain "Miller" Charge	Q_{gd}		-	6	-	nC

IRF420, IRF421, IRF422, IRF423

Electrical Specifications $T_C = 25^\circ\text{C}$, Unless Otherwise Specified (Continued)

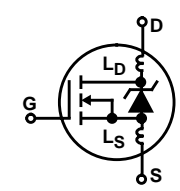
PARAMETER	SYMBOL	TEST CONDITIONS		MIN	TYP	MAX	UNITS
Input Capacitance	C_{ISS}	$V_{DS} = 25\text{V}$, $V_{GS} = 0\text{V}$, $f = 1\text{MHz}$, (Figure 11)		-	300	-	pF
Output Capacitance	C_{OSS}			-	75	-	pF
Reverse Transfer Capacitance	C_{RSS}			-	20	-	pF
Internal Drain Inductance	L_D	Measured between the Contact Screw on the Flange that is Closer to Source and Gate Pins and the Center of Die.	Modified MOSFET Symbol Showing the Internal Devices Inductances. 	-	5.0	-	nH
Internal Source Inductance	L_S	Measured from the Source Lead, 6mm (0.25in) from the Flange and Source Bonding Pad.		-	12.5	-	nH
Thermal Resistance Junction to Case	$R_{\theta JC}$			-	-	2.5	$^\circ\text{C/W}$
Thermal Resistance Junction to Ambient	$R_{\theta JA}$	Free Air Operation		-	-	30	$^\circ\text{C/W}$

Source to Drain Diode Specifications

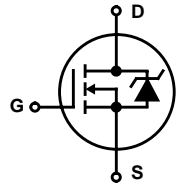
PARAMETER	SYMBOL	TEST CONDITIONS		MIN	TYP	MAX	UNITS
Continuous Source to Drain Current	I_{SD}	Modified MOSFET Symbol Showing the Integral Reverse P-N Junction Diode 		-	-	2.5	A
Pulse Source to Drain Current (Note 3)	I_{SDM}			-	-	10	A
Source to Drain Diode Voltage (Note 2)	V_{SD}	$T_J = 25^\circ\text{C}$, $I_{SD} = 2.5\text{A}$, $V_{GS} = 0\text{V}$, (Figure 13)		-	-	1.4	V
Reverse Recovery Time	t_{rr}	$T_J = 25^\circ\text{C}$, $I_{SD} = 2.5\text{A}$, $dI_{SD}/dt = 100\text{A}/\mu\text{s}$		130	270	540	ns
Reverse Recovered Charge	Q_{RR}	$T_J = 25^\circ\text{C}$, $I_{SD} = 2.5\text{A}$, $dI_{SD}/dt = 100\text{A}/\mu\text{s}$		0.57	1.2	2.3	μC

NOTES:

2. Pulse test: pulse width $\leq 300\mu\text{s}$, duty cycle $\leq 2\%$.
3. Repetitive rating: pulse width limited by max junction temperature. See Transient Thermal Impedance curve (Figure 3).
4. $V_{DD} = 50\text{V}$, starting $T_J = 25^\circ\text{C}$, $L = 60\text{mH}$, $R_G = 25\Omega$, peak $I_{AS} = 2.5\text{A}$, Figures 15, 16.

IRF420, IRF421, IRF422, IRF423

Typical Performance Curves $T_C = 25^\circ\text{C}$ Unless Otherwise Specified

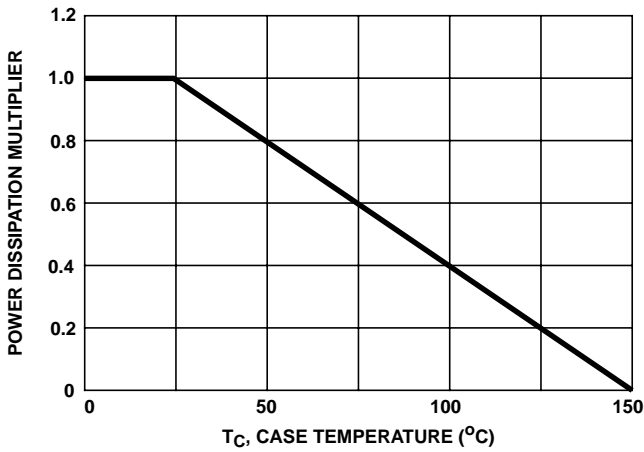

FIGURE 1. NORMALIZED POWER DISSIPATION vs CASE TEMPERATURE

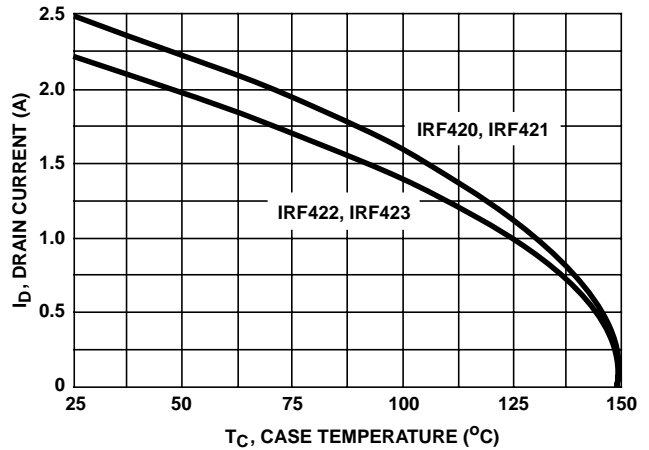

FIGURE 2. MAXIMUM CONTINUOUS DRAIN CURRENT vs CASE TEMPERATURE

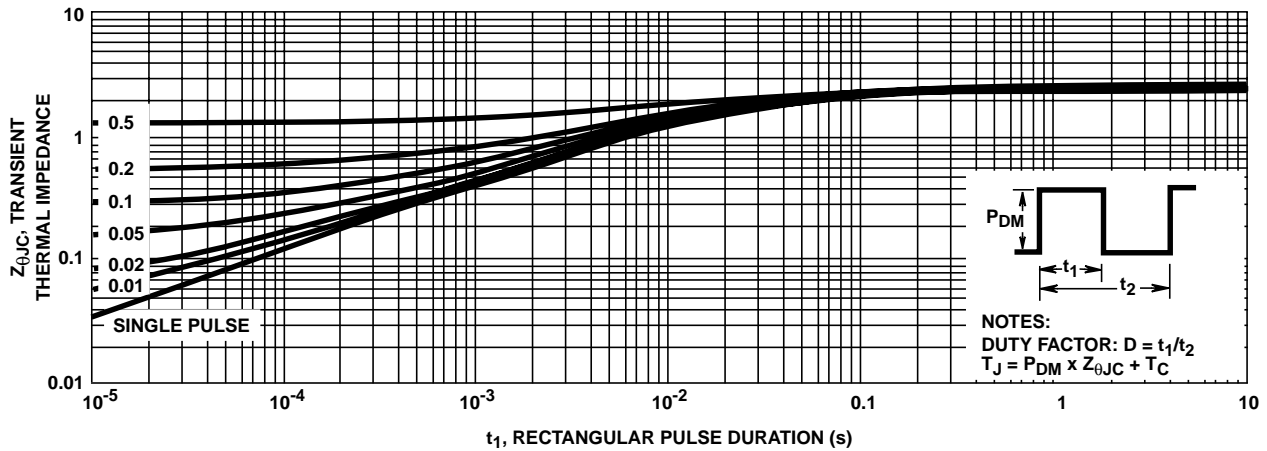

FIGURE 3. MAXIMUM TRANSIENT THERMAL IMPEDANCE

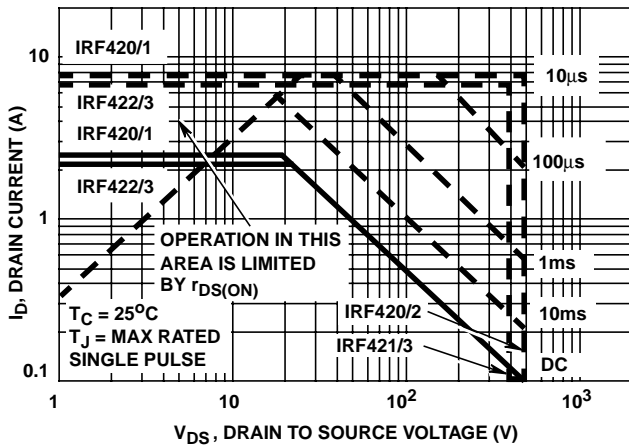

FIGURE 4. FORWARD BIAS SAFE OPERATING AREA

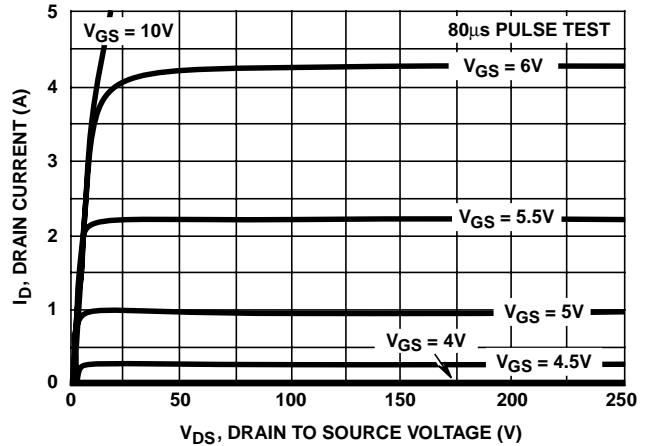

FIGURE 5. OUTPUT CHARACTERISTICS

Typical Performance Curves $T_C = 25^\circ\text{C}$ Unless Otherwise Specified (Continued)

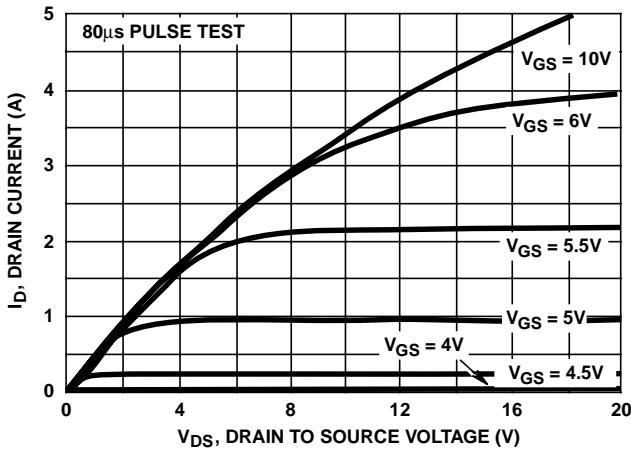

FIGURE 6. SATURATION CHARACTERISTICS

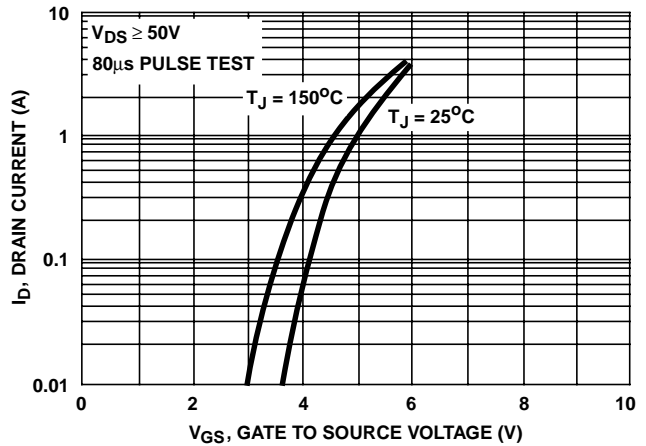
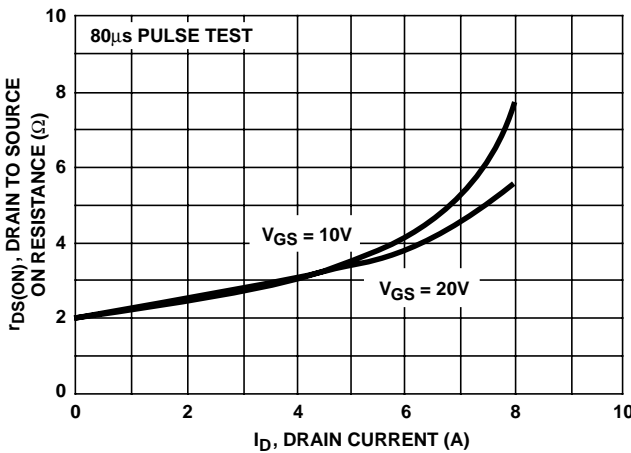

FIGURE 7. TRANSFER CHARACTERISTICS



NOTE: Heating effect of 2µs pulse is minimal.

FIGURE 8. DRAIN TO SOURCE ON RESISTANCE vs GATE VOLTAGE AND DRAIN CURRENT

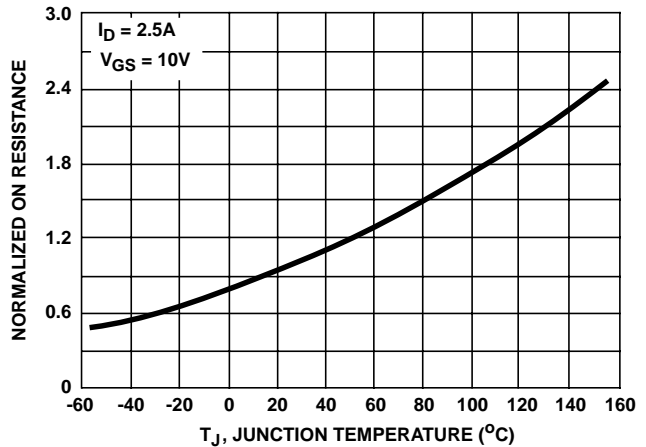

FIGURE 9. NORMALIZED DRAIN TO SOURCE vs JUNCTION TEMPERATURE

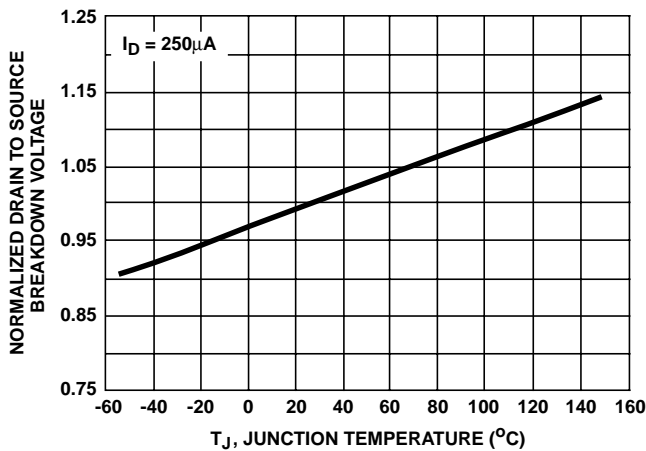

FIGURE 10. NORMALIZED DRAIN TO SOURCE BREAKDOWN VOLTAGE vs JUNCTION TEMPERATURE

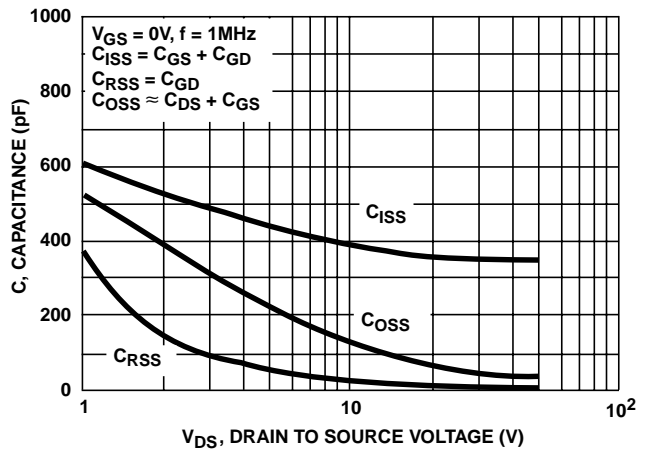

FIGURE 11. CAPACITANCE vs DRAIN TO SOURCE VOLTAGE

Typical Performance Curves $T_C = 25^\circ\text{C}$ Unless Otherwise Specified (Continued)

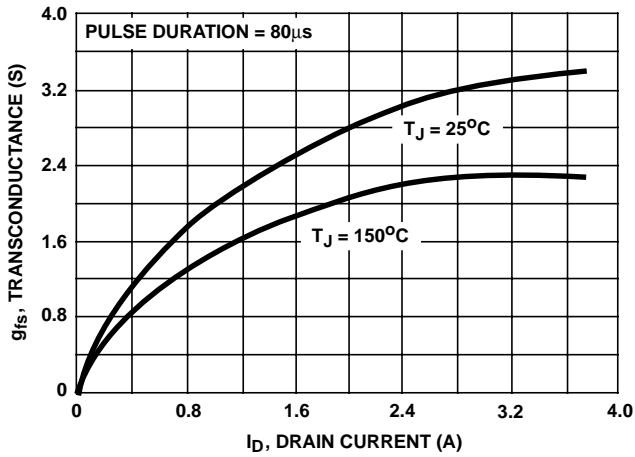

FIGURE 12. TRANSCONDUCTANCE vs DRAIN CURRENT

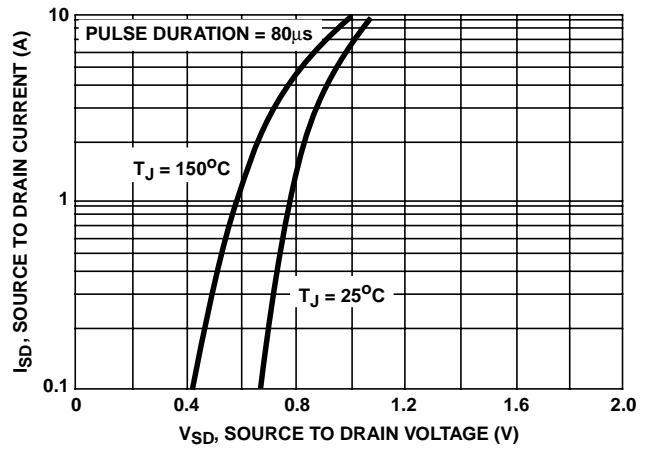

FIGURE 13. SOURCE TO DRAIN DIODE VOLTAGE

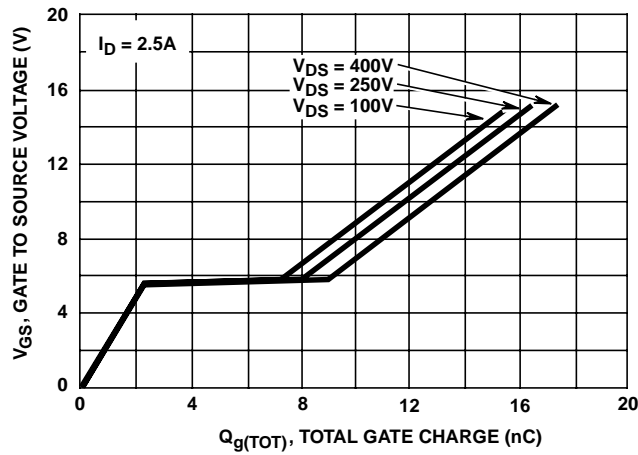

FIGURE 14. GATE TO SOURCE VOLTAGE vs GATE CHARGE

Test Circuits and Waveforms

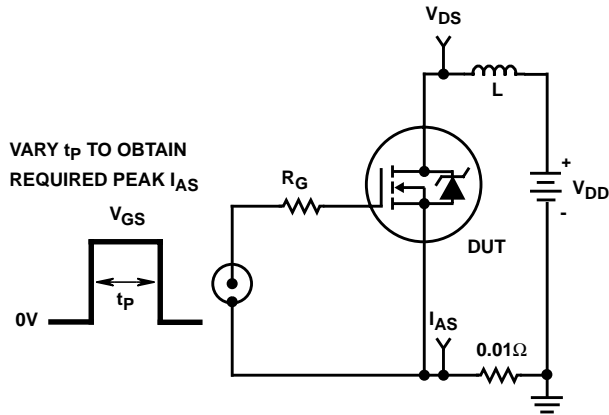

FIGURE 15. UNCLAMPED ENERGY TEST CIRCUIT

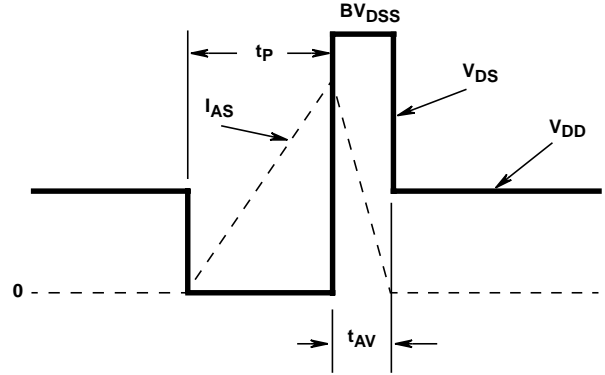

FIGURE 16. UNCLAMPED ENERGY WAVEFORMS

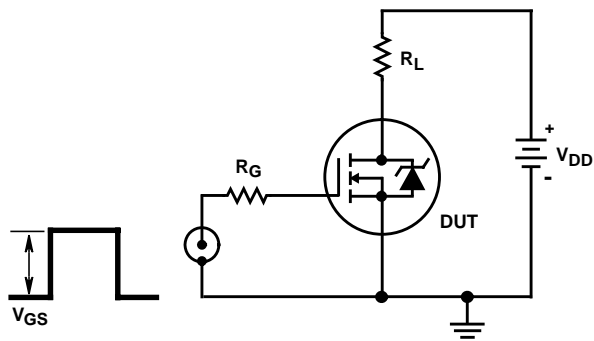

FIGURE 17. SWITCHING TIME TEST CIRCUIT

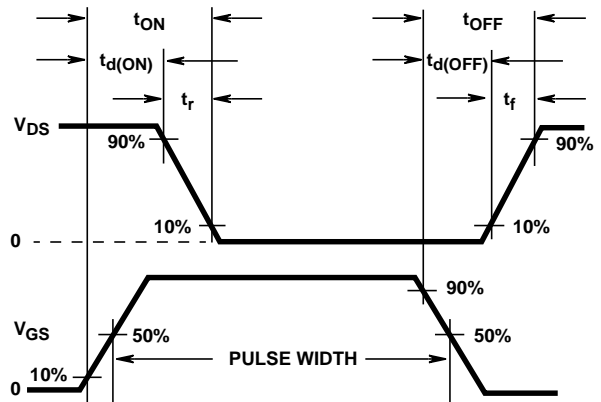

FIGURE 18. RESISTIVE SWITCHING WAVEFORMS

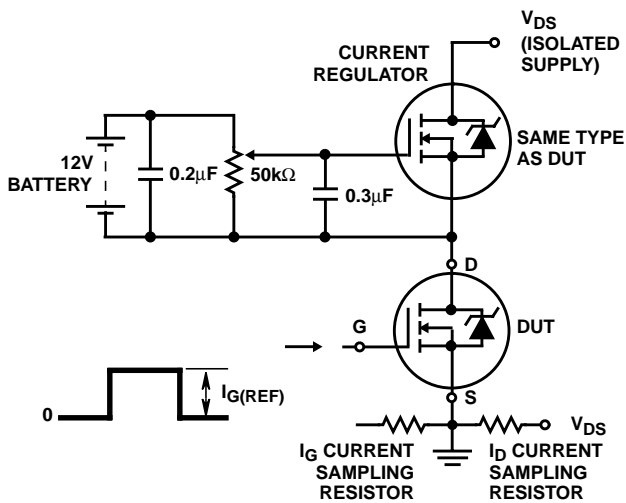

FIGURE 19. GATE CHARGE TEST CIRCUIT

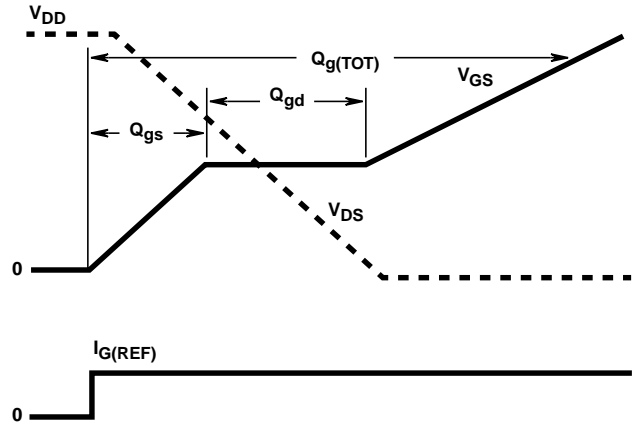

FIGURE 20. GATE CHARGE WAVEFORMS