

SG - 112

The SG – 112 reflective sensor for paper sensing combine high - output GaAs IRED with high sensitive phototransistor. It is most applicable to paper sensor.

FEATURES

- PWB direct mount type
- The most suitable detection distance : 3.0mm
- With the installation positioning boss
- Low profile

APPLICATIONS

- Printers
- Facsimiles
- CD – ROM drives
- DVD – ROM drives

DIMENSIONS

(Unit : mm)

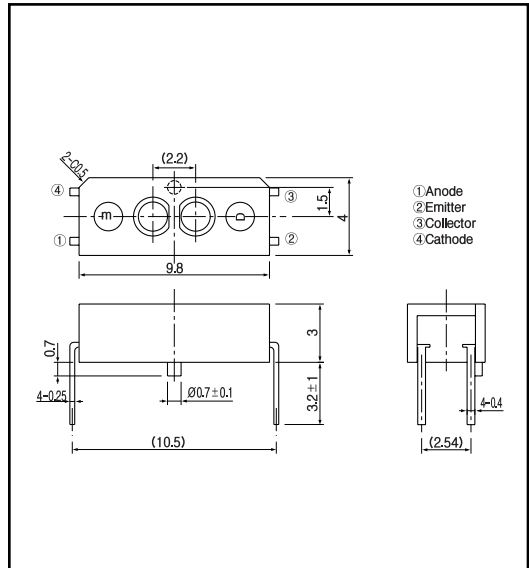

MAXIMUM RATINGS

(Ta=25)

	Item	Symbol	Rating	Unit
Input	Power dissipation	P_D	75	mW
	Forward current	I_F	50	mA
	Reverse voltage	V_R	5	V
	Pulse forward current ^{*1}	I_{FP}	1	A
Output	Collector power dissipation	P_C	75	mW
	Collector current	I_C	20	mA
	C - E voltage	V_{CE0}	30	V
	E - C voltage	V_{EC0}	5	V
	Operating temp. ^{*2}	T_{opr}	- 20 ~ +85	
	Storage temp. ^{*2}	T_{stg}	- 30 ~ +85	
	Soldering temp. ^{*3}	T_{sol}	260	

*1. pulse width : t w 100 μ sec,period : T=10msec.

*2. No icebound or dew *3. For MAX.5 seconds at the position of 1mm from the package

ELECTRO-OPTICAL CHARACTERISTICS

(Ta=25)

	Item	Symbol	Conditions	Min.	Typ.	Max.	Unit.
Input	Forward voltage	V_F	$I_F=20mA$		1.2	1.4	V
	Reverse current	I_R	$V_R=5V$			10	μA
	Peak wavelength	λ_p	$I_F=20mA$		940		nm
Output	Collector dark current	I_{CE0}	$V_{CE}=10V$		1	100	nA
	Light current	I_C	$I_F=20mA, V_E=5V, L=2mm$	0.2		2.4	mA
Transmissi	Package current	I_{CEOD}	$I_F=20mA, V_E=5V(Non-reflector)$			20	μA
	C - E saturation voltage	$V_{CE(sat)}$	$I_F=20mA, I_C=0.1mA$		0.15	0.4	V
	Rise time	t_r	$V_{CC}=5V, I_C=0.3mA, R=100$		5		μ sec.
Fall time	t_f			5		μ sec.	

Photo interrupters(Reflective)

SG - 112

Collector power dissipation Vs. Ambient temperature

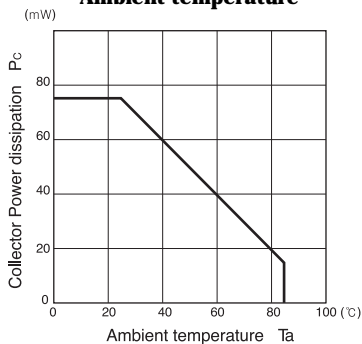

Forward current Vs. Forward voltage

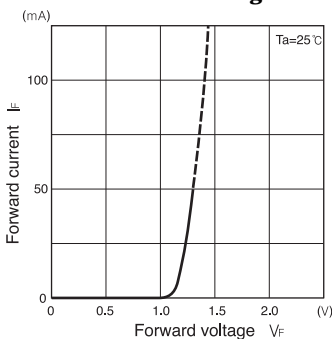

Light current Vs. Forward current

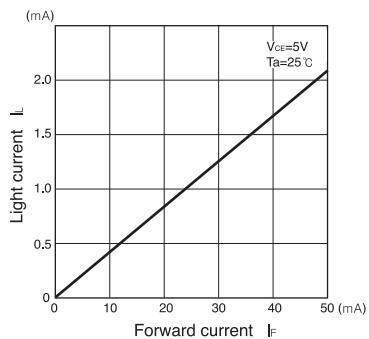

Light current Vs. Collector-Emitter voltage

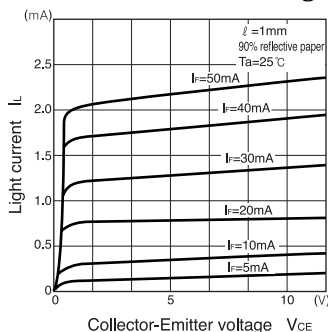

Relative light current Vs. Ambient temperature

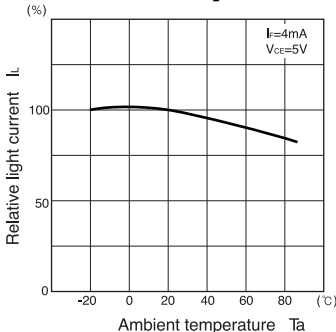

Dark current Vs. Ambient temperature

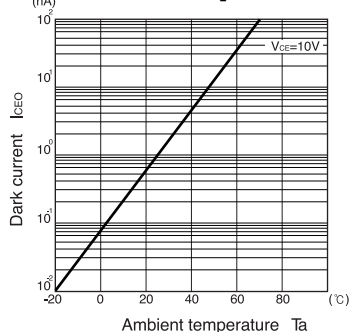

Switching time Vs. Load resistance

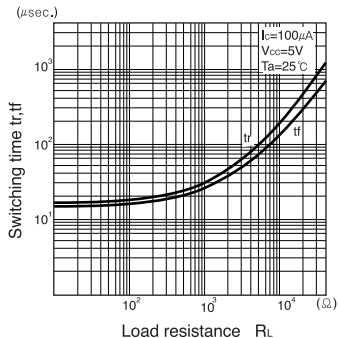

Relative light current Vs. Moving distance

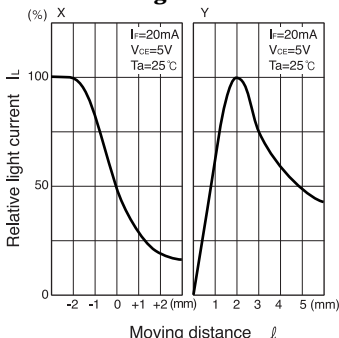

Switching time measurement circuit

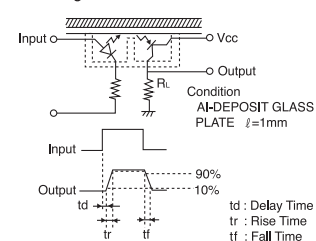

Method of measuring position detection characteristic

