

NPN Silicon AF Transistors

- For AF input stages and driver applications
- High current gain
- Low collector-emitter saturation voltage
- Low noise between 30 Hz and 15 kHz
- Complementary types: BC856, BC857, BC858
BC859, BC860 (PNP)

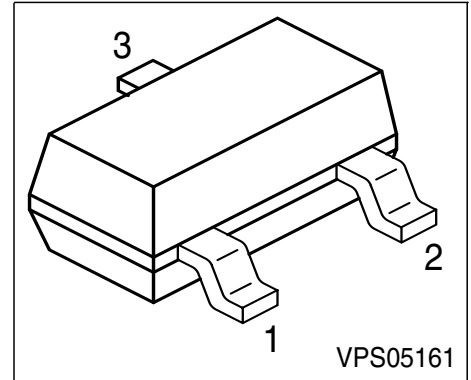

Type	Marking	Pin Configuration			Package
BC846A	1As	1 = B	2 = E	3 = C	SOT23
BC846B	1Bs	B = 1	2 = E	3 = C	SOT23
BC847A	1Es	B = 1	2 = E	3 = C	SOT23
BC847B	1Fs	1 = B	2 = E	3 = C	SOT23
BC847C	1Gs	1 = B	2 = E	3 = C	SOT23
BC848A	1Js	1 = B	2 = E	3 = C	SOT23
BC848B	1Ks	1 = B	2 = E	3 = C	SOT23
BC848C	1Ls	1 = B	2 = E	3 = C	SOT23
BC849B	2Bs	1 = B	2 = E	3 = C	SOT23
BC849C	2Cs	1 = B	2 = E	3 = C	SOT23
BC850B	2Fs	1 = B	2 = E	3 = C	SOT23
BC850C	2Gs	1 = B	2 = E	3 = C	SOT23

Maximum Ratings

Parameter	Symbol	BC846	BC847	BC848	Unit
			BC850	BC849	
Collector-emitter voltage	V_{CEO}	65	45	30	V
Collector-base voltage	V_{CBO}	80	50	30	
Collector-emitter voltage	V_{CES}	80	50	30	
Emitter-base voltage	V_{EBO}	6	6	5	
DC collector current	I_C	100			mA
Peak collector current	I_{CM}	200			mA
Peak base current	I_{BM}	200			
Peak emitter current	I_{EM}	200			
Total power dissipation, $T_S = 71\text{ °C}$	P_{tot}	330			mW
Junction temperature	T_j	150			°C
Storage temperature	T_{stg}	-65 ... 150			

Thermal Resistance

Junction - soldering point ¹⁾	R_{thJS}	≤240	K/W
--	------------	------	-----

Electrical Characteristics at $T_A = 25\text{ °C}$, unless otherwise specified.

Parameter	Symbol	Values			Unit
		min.	typ.	max.	

DC Characteristics

Collector-emitter breakdown voltage $I_C = 10\text{ mA}$, $I_B = 0$		$V_{(BR)CEO}$				V
BC846	65	-	-			
BC847/850	45	-	-			
	BC848/849	30	-	-		
Collector-base breakdown voltage $I_C = 10\text{ }\mu\text{A}$, $I_E = 0$		$V_{(BR)CBO}$				
BC846	80	-	-			
BC847/850	50	-	-			
	BC848/849	30	-	-		

¹⁾For calculation of R_{thJA} please refer to Application Note Thermal Resistance

Electrical Characteristics at $T_A = 25^\circ\text{C}$, unless otherwise specified.

Parameter	Symbol	Values			Unit
		min.	typ.	max.	
DC Characteristics					
Collector-emitter breakdown voltage $I_C = 10 \mu\text{A}$, $V_{BE} = 0$	$V_{(BR)CES}$				V
BC846		80	-	-	
BC847/850		50	-	-	
BC848/849		30	-	-	
Emitter-base breakdown voltage $I_E = 1 \mu\text{A}$, $I_C = 0$	$V_{(BR)EBO}$				
BC846/847		6	-	-	
BC848-850		5	-	-	
Collector cutoff current $V_{CB} = 40 \text{V}$, $I_E = 0$	I_{CBO}	-	-	15	nA
Collector cutoff current $V_{CB} = 30 \text{V}$, $I_E = 0$, $T_A = 150^\circ\text{C}$	I_{CBO}	-	-	5	μA
DC current gain 1) $I_C = 10 \mu\text{A}$, $V_{CE} = 5 \text{V}$	h_{FE}				-
h_{FE} -group A		-	140	-	
h_{FE} -group B		-	250	-	
h_{FE} -group C		-	480	-	
DC current gain 1) $I_C = 2 \text{mA}$, $V_{CE} = 5 \text{V}$	h_{FE}				
h_{FE} -group A		110	180	220	
h_{FE} -group B		200	290	450	
h_{FE} -group C		420	520	800	
Collector-emitter saturation voltage1) $I_C = 10 \text{mA}$, $I_B = 0.5 \text{mA}$ $I_C = 100 \text{mA}$, $I_B = 5 \text{mA}$	V_{CEsat}				mV
$I_C = 10 \text{mA}$, $I_B = 0.5 \text{mA}$		-	90	250	
$I_C = 100 \text{mA}$, $I_B = 5 \text{mA}$		-	200	600	
Base-emitter saturation voltage 1) $I_C = 10 \text{mA}$, $I_B = 0.5 \text{mA}$ $I_C = 100 \text{mA}$, $I_B = 5 \text{mA}$	V_{BEsat}				
$I_C = 10 \text{mA}$, $I_B = 0.5 \text{mA}$		-	700	-	
$I_C = 100 \text{mA}$, $I_B = 5 \text{mA}$		-	900	-	
Base-emitter voltage 1) $I_C = 2 \text{mA}$, $V_{CE} = 5 \text{V}$ $I_C = 10 \text{mA}$, $V_{CE} = 5 \text{V}$	$V_{BE(ON)}$				
$I_C = 2 \text{mA}$, $V_{CE} = 5 \text{V}$		580	660	700	
$I_C = 10 \text{mA}$, $V_{CE} = 5 \text{V}$		-	-	770	

 1) Pulse test: $t \leq 300\mu\text{s}$, $D = 2\%$

Electrical Characteristics at $T_A = 25^\circ\text{C}$, unless otherwise specified.

Parameter	Symbol	Values			Unit
		min.	typ.	max.	
AC Characteristics					
Transition frequency $I_C = 10\text{ mA}$, $V_{CE} = 5\text{ V}$, $f = 100\text{ MHz}$	f_T	-	250	-	MHz
Collector-base capacitance $V_{CB} = 10\text{ V}$, $f = 1\text{ MHz}$	C_{cb}	-	3	-	pF
Emitter-base capacitance $V_{EB} = 0.5\text{ V}$, $f = 1\text{ MHz}$	C_{eb}	-	8	-	
Short-circuit input impedance $I_C = 2\text{ mA}$, $V_{CE} = 5\text{ V}$, $f = 1\text{ kHz}$	h_{11e}				k Ω
$h_{FE-gr.A}$		-	2.7	-	
$h_{FE-gr.B}$		-	4.5	-	
$h_{FE-gr.C}$		-	8.7	-	
Open-circuit reverse voltage transf.ratio $I_C = 2\text{ mA}$, $V_{CE} = 5\text{ V}$, $f = 1\text{ kHz}$	h_{12e}				10^{-4}
$h_{FE-gr.A}$		-	1.5	-	
$h_{FE-gr.B}$		-	2	-	
$h_{FE-gr.C}$		-	3	-	
Short-circuit forward current transf.ratio $I_C = 2\text{ mA}$, $V_{CE} = 5\text{ V}$, $f = 1\text{ kHz}$	h_{21e}				-
$h_{FE-gr.A}$		-	200	-	
$h_{FE-gr.B}$		-	330	-	
$h_{FE-gr.C}$		-	600	-	
Open-circuit output admittance $I_C = 2\text{ mA}$, $V_{CE} = 5\text{ V}$, $f = 1\text{ kHz}$	h_{22e}				μS
$h_{FE-gr.A}$		-	18	-	
$h_{FE-gr.B}$		-	30	-	
$h_{FE-gr.C}$		-	60	-	
Noise figure $I_C = 200\text{ }\mu\text{A}$, $V_{CE} = 5\text{ V}$, $R_S = 2\text{ k}\Omega$, $f = 1\text{ kHz}$, $\Delta f = 200\text{ Hz}$	F	-	1.2	4	dB
Equivalent noise voltage $I_C = 200\text{ }\mu\text{A}$, $V_{CE} = 5\text{ V}$, $R_S = 2\text{ k}\Omega$, $f = 10 \dots 50\text{ Hz}$	V_n	-	-	0.135	μV

Total power dissipation $P_{tot} = f(T_S)$

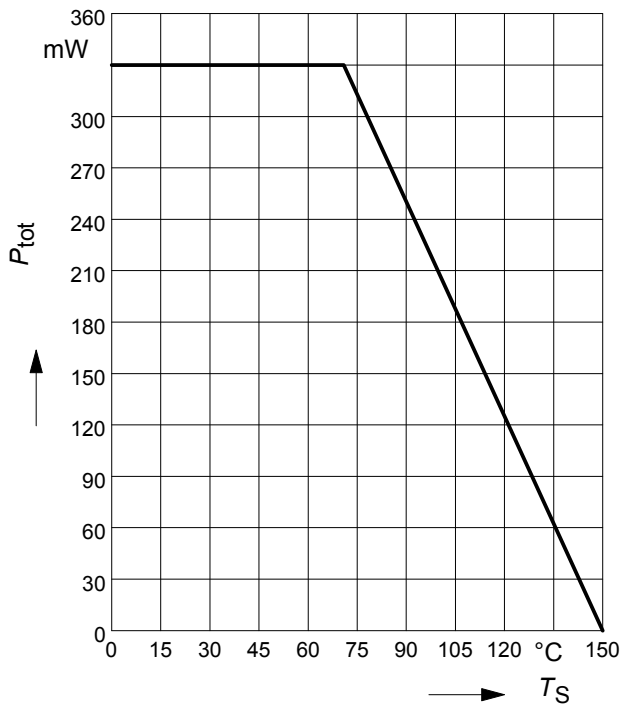

**Collector-base capacitance $C_{CB} = f(V_{CBO})$
Emitter-base capacitance $C_{EB} = f(V_{EBO})$**

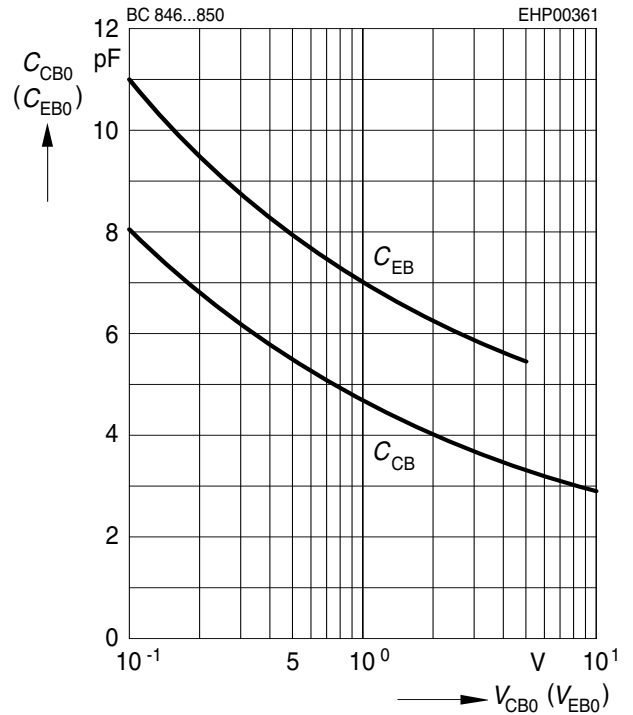

Permissible pulse load

$P_{totmax} / P_{totDC} = f(t_p)$

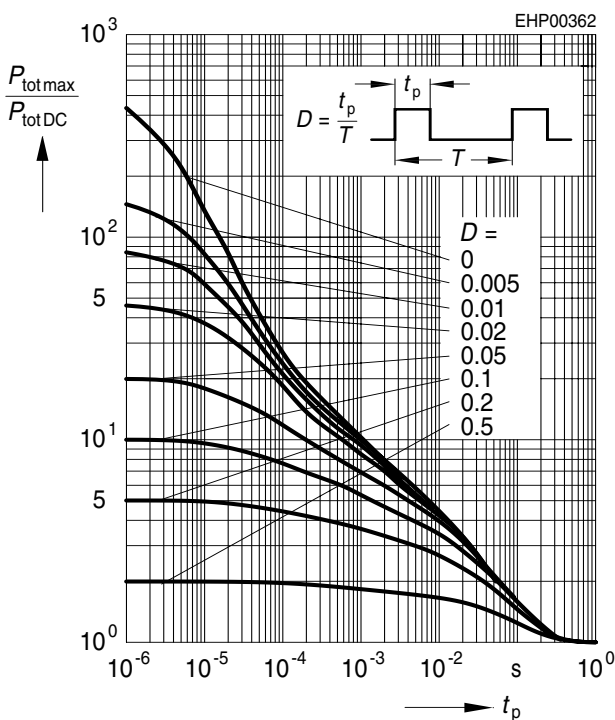

Transition frequency $f_T = f(I_C)$

$V_{CE} = 5V$

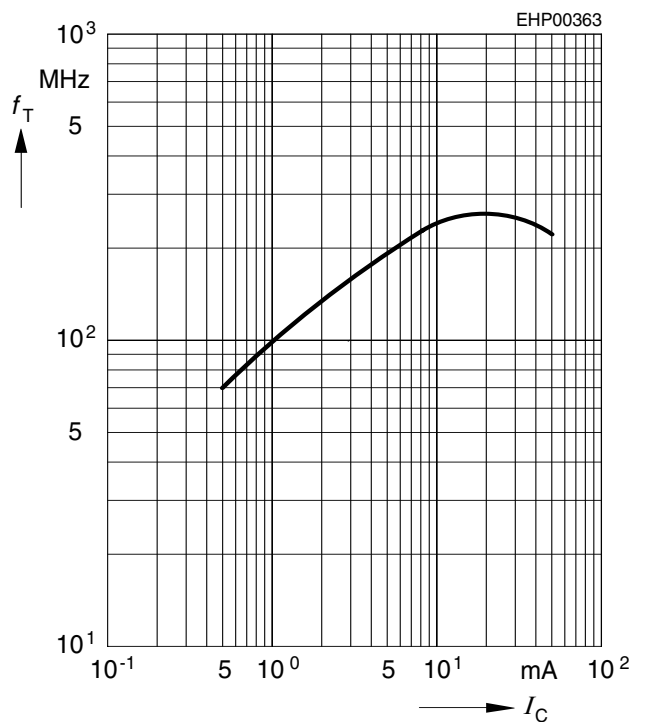

Collector cutoff current $I_{CBO} = f(T_A)$

$V_{CB} = 30V$

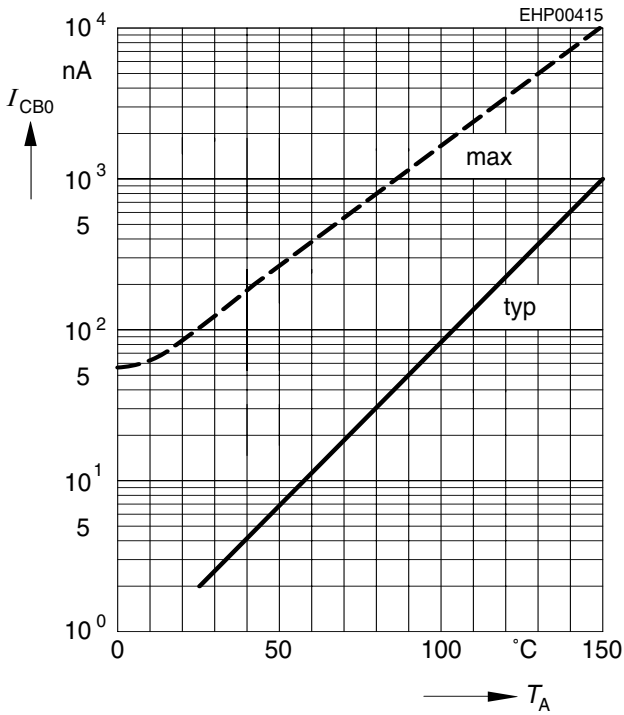

Collector-emitter saturation voltage

$I_C = f(V_{CEsat}), h_{FE} = 20$

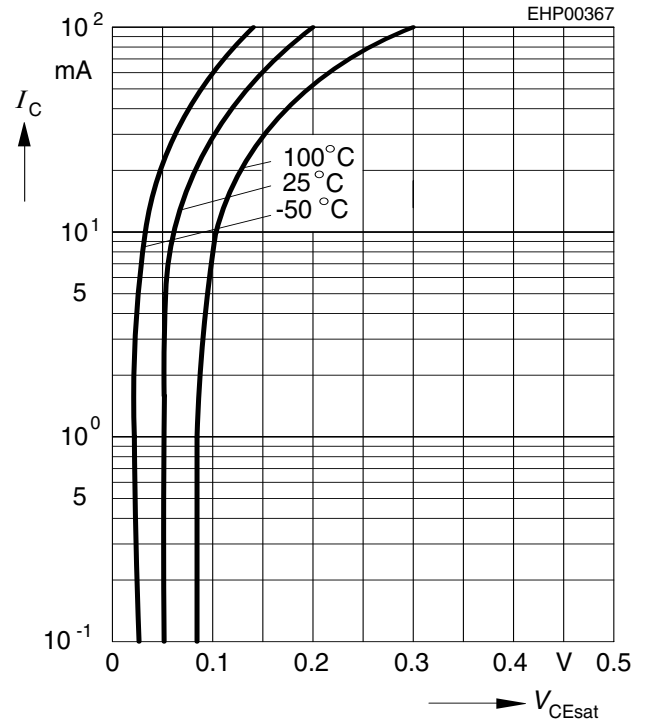

DC current gain $h_{FE} = f(I_C)$

$V_{CE} = 5V$

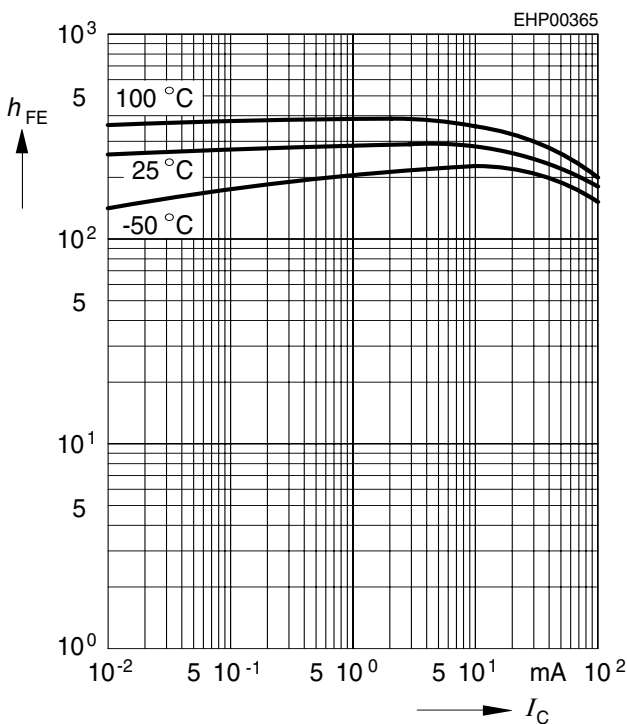

Base-emitter saturation voltage

$I_C = f(V_{BEsat}), h_{FE} = 20$

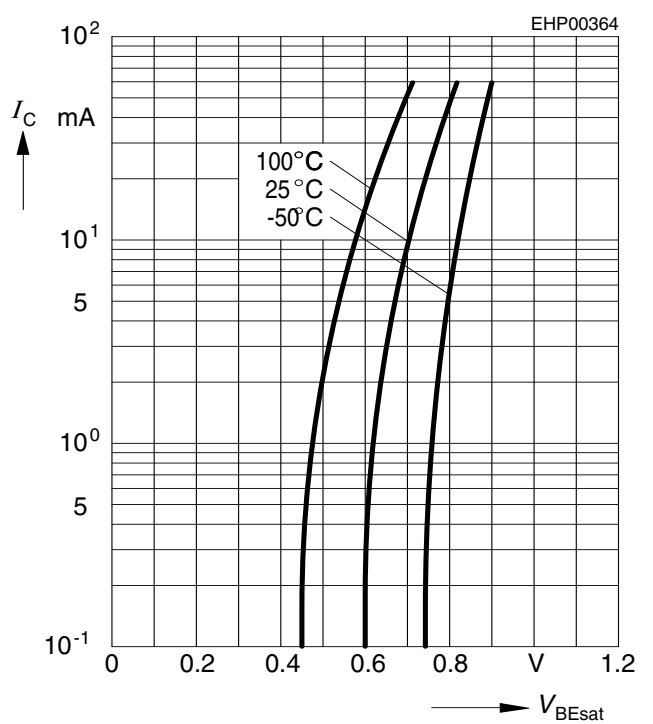

h parameter $h_e = f(I_C)$ normalized

$V_{CE} = 5V$

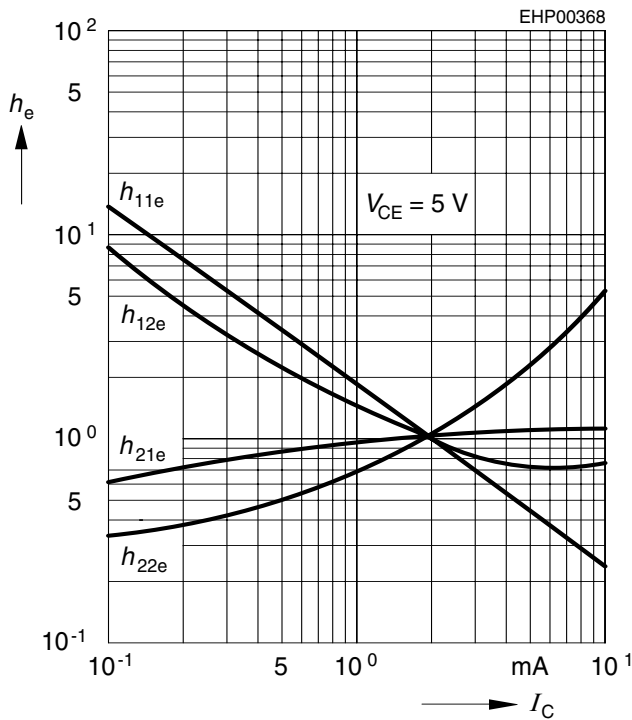

h parameter $h_e = f(V_{CE})$ normalized

$I_C = 2mA$

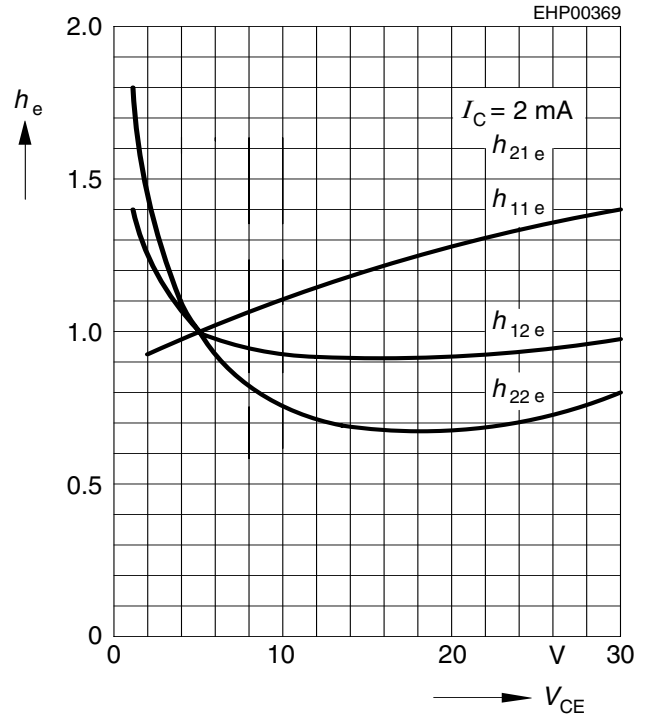

Noise figure $F = f(V_{CE})$

$I_C = 0.2mA, R_S = 2k\Omega, f = 1kHz$

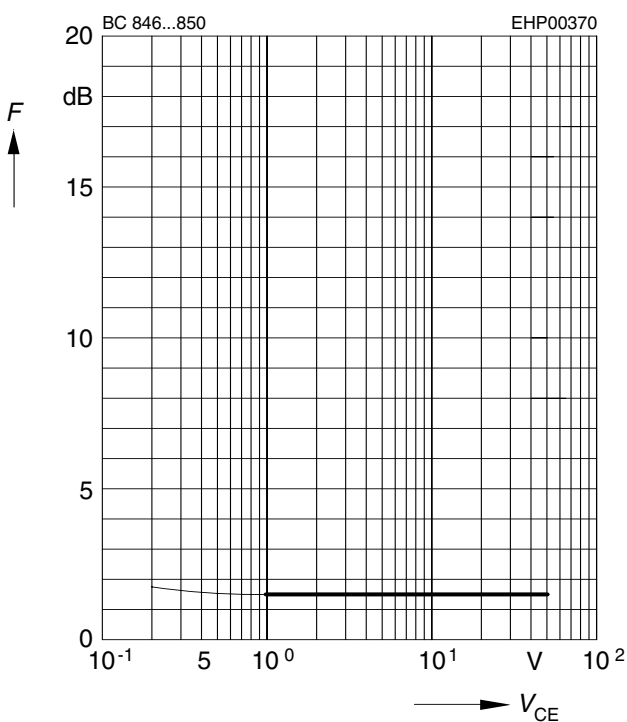

Noise figure $F = f(f)$

$I_C = 0.2mA, V_{CE} = 5V, R_S = 2k\Omega$

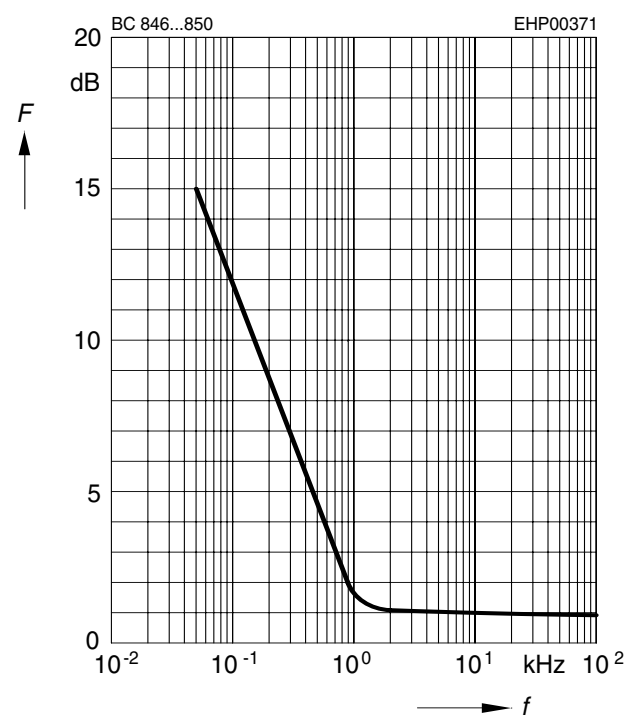

Noise figure $F = f(I_C)$

$V_{CE} = 5V, f = 120Hz$

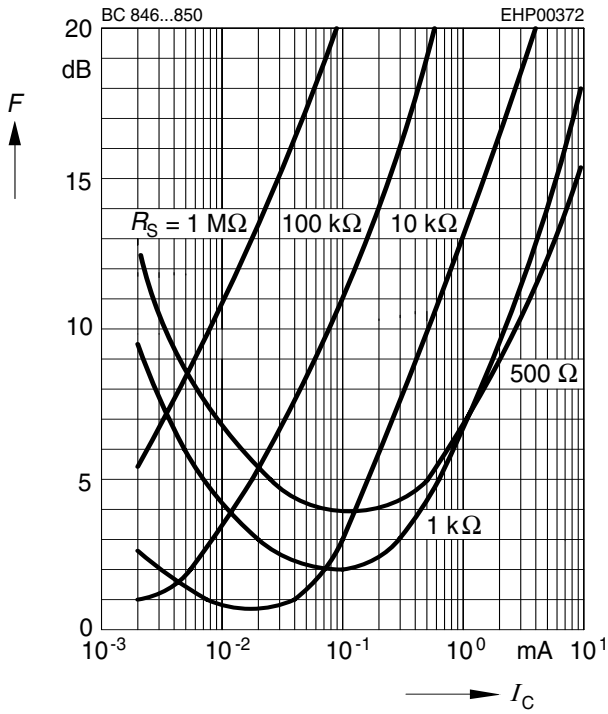

Noise figure $F = f(I_C)$

$V_{CE} = 5V, f = 1kHz$

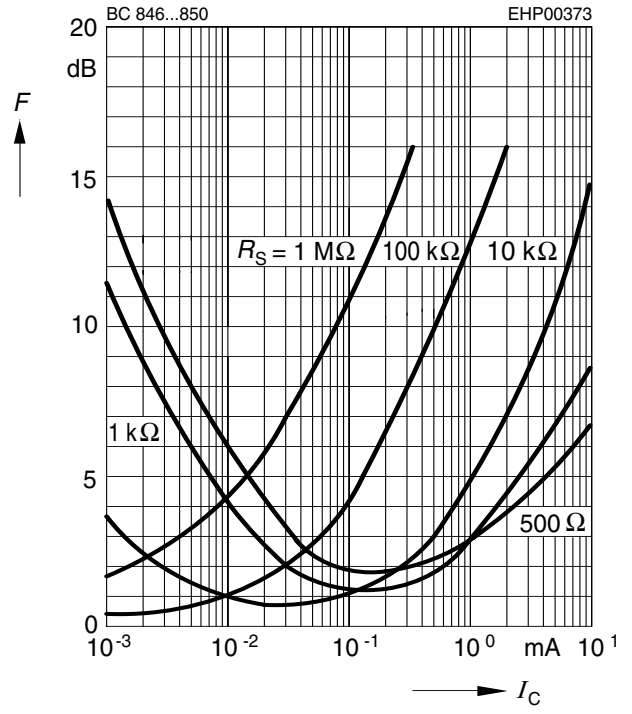

Noise figure $F = f(I_C)$

$V_{CE} = 5V, f = 10kHz$

