

---

## Description

The CXA2726GA is a PDIC (photodetector IC) developed as a photodetector for the optical pickup of DVD±R/RW and RAM drives.

The photodiode and circuits operate at high speed to allow high-speed read and write. This IC also has a sleep function and small COB (Chip On Board) package.

(Applications: Optical pickups for DVD±R/RW and RAM)

---

## Features

- ◆ Wide band (120MHz)
- ◆ RF differential output (Read Mode: A to D signal addition output)
- ◆ WPP output (WPP1 = A + B, WPP2 = C + D signal addition output)
- ◆ Mode switching function (6-Mode switching + Power save mode: SW1, SW2)
- ◆ 12-division photodiode supporting DPP
- ◆ Small COB package of Land Grid Array type
- ◆ Sleep function (Power save mode)

---

## Package

18-pin LFLGA (Plastic)

---

## Structure

Bipolar silicon monolithic IC

Sony reserves the right to change products and specifications without prior notice. This information does not convey any license by any implication or otherwise under any patents or other right. Application circuits shown, if any, are typical examples illustrating the operation of the devices. Sony cannot assume responsibility for any problems arising out of the use of these circuits.

## Absolute Maximum Ratings

(Ta = 25°C)

◆ Supply voltage	Vcc	5.5	V
◆ Operating temperature	Topr	-10 to +80	°C
◆ Storage temperature	Tstg	-40 to +100	°C
◆ Allowable power dissipation	Pd	550	mW

## Operating Conditions

◆ Supply voltage 1	Vcc	4.5 to 5.5	V
◆ Supply voltage 2	Vc	1.3 to 2.5	V
◆ SW1, SW2: Low	Vsw	0 to 0.4	V
◆ SW1, SW2: Middle	Vsw	1.2 to 2.0	V
◆ SW1, SW2: High	Vsw	2.9 to Vcc	V or OPEN

## Output Sensitivity Table

Mode	Name	SW1	SW2	Main	Sub	RF	WPP	Unit
1	Read	Low	Middle	10.00	40.20	8.95	1.67	mV/μW
2		Low	High/Hi-Z	22.40	90.00	20.10	3.73	
3	Write	Middle	Middle	1.30	5.23	—	0.87	
4		Middle	High/Hi-Z	2.91	11.71	—	1.95	
5		High/Hi-Z	Middle	1.00	4.02	—	0.67	
6		High/Hi-Z	High/Hi-Z	2.24	9.01	—	1.50	
SLEEP	Sleep	Don't care	Low	—	—	—	—	

Block Diagram

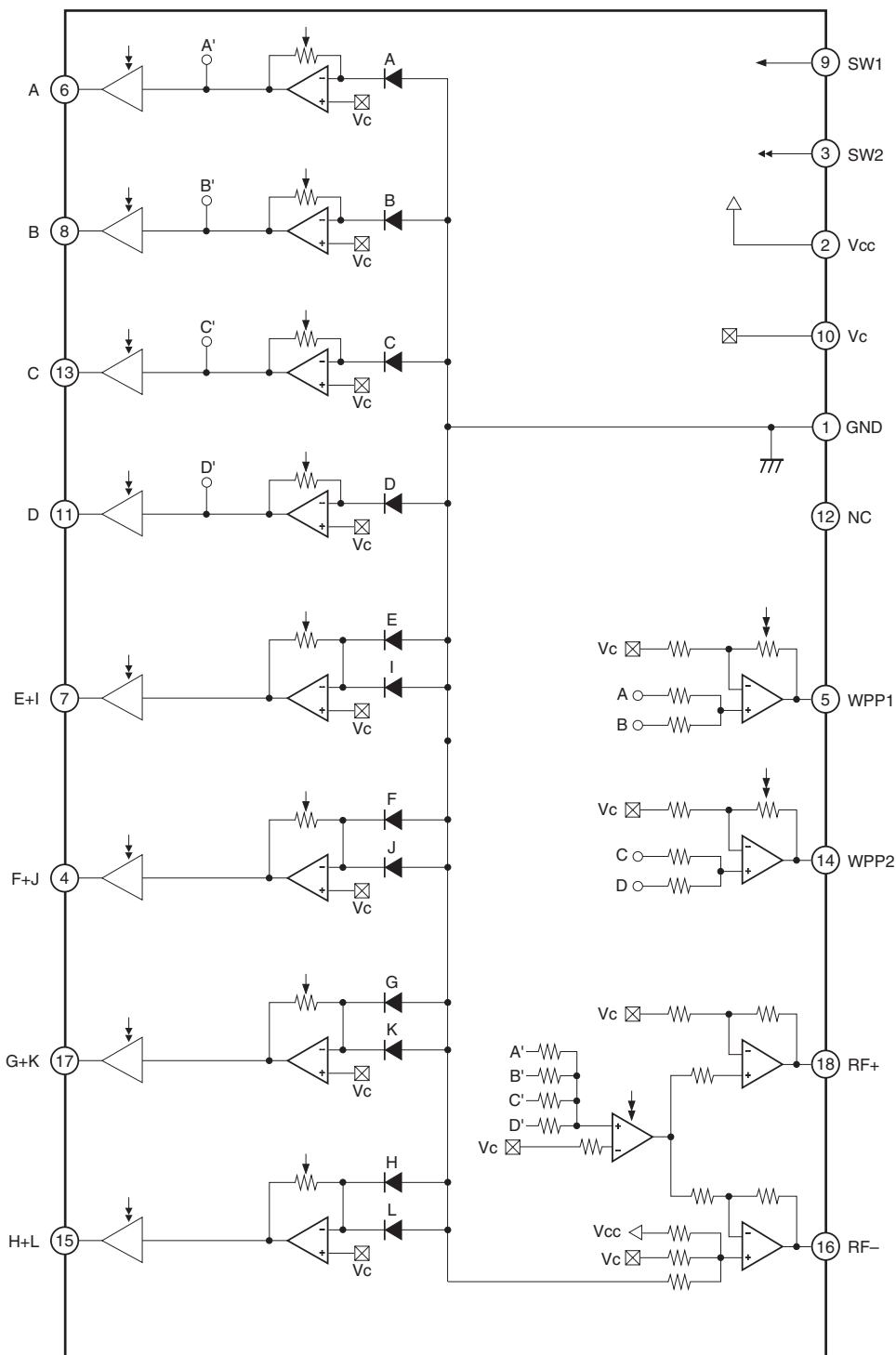

Arithmetic Formulas

- $RF+ = 0.895 \times (A_o + B_o + C_o + D_o)$
- $RF- = -0.895 \times (A_o + B_o + C_o + D_o)$
- $WPP1 = (A_o + B_o) \times \alpha$
- $WPP2 = (C_o + D_o) \times \alpha$

\* In each mode,  $\alpha$  is as follows.

Mode1 and 2 : 0.167

Mode3 to 6 : 0.669

\* RF+ and RF- operate only in Mode-1 and Mode-2.

Pin Configuration

(Top View)

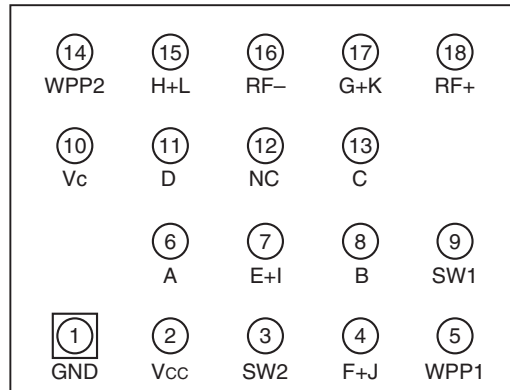

Pin Description

Pin No.	Symbol	I/O	Equivalent circuit	Description
1	GND	I		For a dual power supply: Negative power supply For a single power supply: GND
2	Vcc	I		Positive power supply.
3	SW2	I		Mode switching input. 0 to 0.4V: Low 1.2 to 2.0V: Middle 2.9V to Vcc: High

Pin No.	Symbol	I/O	Equivalent circuit	Description
7 4 17 15	E+I F+J G+K H+L	O		Output of voltage signals converted from optical signals.
5 14	WPP1 WPP2	O		Non-inverted output of added A to D signals.  WPP1 = A + B WPP2 = C + D
6 8 13 11	A B C D	O		Output of voltage signals converted from optical signals.
9	SW1	I		Mode switching input. 0 to 0.4V: Low 1.2 to 2.0V: Middle 2.9V to Vcc: High
10	Vc	I		For a dual power supply: GND For a single power supply: Center voltage input

Pin No.	Symbol	I/O	Equivalent circuit	Description
16	RF-	O		Inverted output of added A to D signals.
18	RF+	O		Non-inverted output of added A to D signals.

**Electrical and Optical Characteristics 1 (Mode-1: Read Mode/Low Gain)**

 (V<sub>CC</sub> = 5.0V, V<sub>C</sub> = 1.4V, V<sub>sw1</sub> = 0V, V<sub>sw2</sub> = 1.65V, T<sub>a</sub> = 25°C)

Item	Symbol	Conditions	Min.	Typ.	Max.	Unit
Current consumption	I <sub>CC</sub>	In the dark	—	44.0	57.5	mA
Output offset voltage (A to D)	V <sub>off</sub>	In the dark, V <sub>C</sub> reference	-30	0	30	mV
Output offset voltage (E+I to H+L)	V <sub>off</sub>	In the dark, V <sub>C</sub> reference	-35	0	35	mV
Output offset voltage (WPP1, WPP2)	V <sub>off</sub>	In the dark, V <sub>C</sub> reference	-30	0	30	mV
Output offset voltage (RF+)	V <sub>off</sub>	In the dark, V <sub>C</sub> reference	-110	0	110	mV
Output offset voltage (RF-)	V <sub>off</sub>	In the dark, V <sub>CC</sub> - V <sub>C</sub> reference	-110	0	110	mV
Output offset matrix	ΔV <sub>off</sub>	(A + B) - (C + D), In the dark	-30	0	30	mV
		(A + D) - (B + C), In the dark	-30	0	30	mV
		(A + C) - (B + D), In the dark	-30	0	30	mV
		(G + H + K + L) - (E + F + I + J), In the dark	-30	0	30	mV
		A + B + C + D, In the dark	-50	0	50	mV
		E + F + G + H + I + J + K + L, In the dark	-50	0	50	mV
		(RF+) - (RF-), In the dark	-160	0	160	mV
Offset temperature drift (A to D) *	ΔV <sub>off</sub> /T	In the dark	-100	0	100	μV/°C
Offset temperature drift (E+I to H+L) *	ΔV <sub>off</sub> /T	In the dark	-150	0	150	μV/°C
Offset temperature drift (WPP1, WPP2) *	ΔV <sub>off</sub> /T	In the dark	-100	0	100	μV/°C
Offset temperature drift (RF+, RF-) *	ΔV <sub>off</sub> /T	In the dark	-1	0	1	mV/°C
Output voltage (A to D) *	V <sub>o</sub>	λ = 650nm, 780nm, P <sub>o</sub> = 10μW	7.5	10.0	12.5	mV/μW
Output voltage (E+I to H+L) *	V <sub>o</sub>	λ = 650nm, 780nm, P <sub>o</sub> = 10μW	30.15	40.20	50.25	mV/μW
Output voltage (WPP1, WPP2) *	V <sub>o</sub>	λ = 650nm, 780nm, P <sub>o</sub> = 10μW	1.25	1.67	2.09	mV/μW
Output voltage (RF+) *	V <sub>o</sub>	λ = 650nm, 780nm, P <sub>o</sub> = 10μW	6.71	8.95	11.19	mV/μW
Output voltage (RF-) *	V <sub>o</sub>	λ = 650nm, 780nm, P <sub>o</sub> = 10μW	-11.19	-8.95	-6.71	mV/μW
Output voltage ratio (E+I to H+L)/(A to D) *	V <sub>OR</sub>	λ = 650nm, 780nm, P <sub>o</sub> = 10μW	3.91	4.12	4.33	—
Output voltage ratio ((RF+) + (RF-))/(A to D) *	V <sub>OR</sub>	λ = 650nm, 780nm, P <sub>o</sub> = 10μW	1.77	1.86	1.95	—
Maximum output potential (A to D, E+I to H+L)	V <sub>omax</sub>	λ = 650nm, 780nm, P <sub>o</sub> = 1mW	3.8	4.0	—	V

Item	Symbol	Conditions	Min.	Typ.	Max.	Unit
Maximum output potential (WPP1, WPP2)	Vomax	$\lambda = 650\text{nm}, 780\text{nm}, P_o = 1\text{mW}$	2.0	2.2	—	V
Maximum output potential (RF+)	Vomax	$\lambda = 650\text{nm}, 780\text{nm}, P_o = 1\text{mW}$	3.8	4.0	—	V
Minimum output potential (RF-)	Vomin	$\lambda = 650\text{nm}, 780\text{nm}, P_o = 1\text{mW}$	—	1.0	1.2	V
Frequency response (A to D) *	fc	$\lambda = 650\text{nm}, 780\text{nm}$ $P_o = 10\mu\text{W}_{\text{DC}} + 4\mu\text{W}_{\text{p-p}}$ 100kHz reference, -3dB	90	120	—	MHz
Frequency response (E+I to H+L) *	fc	$\lambda = 650\text{nm}, 780\text{nm}$ $P_o = 10\mu\text{W}_{\text{DC}} + 4\mu\text{W}_{\text{p-p}}$ 100kHz reference, -3dB	20	30	—	MHz
Frequency response (WPP1, WPP2) *	fc	$\lambda = 650\text{nm}, 780\text{nm}$ $P_o = 10\mu\text{W}_{\text{DC}} + 4\mu\text{W}_{\text{p-p}}$ 100kHz reference, -3dB	90	120	—	MHz
Frequency response ((RF+) - (RF-)) *	fc	$\lambda = 650\text{nm}, 780\text{nm}$ $P_o = 10\mu\text{W}_{\text{DC}} + 4\mu\text{W}_{\text{p-p}}$ 100kHz reference, -3dB	90	120	—	MHz
Group delay difference 1 (A to D) *	$\Delta\text{Gd1}$	100kHz to 70MHz	—	1.0	—	ns
Group delay difference 1 (WPP1, WPP2) *	$\Delta\text{Gd1}$	100kHz to 70MHz	—	1.1	—	ns
Group delay difference 1 ((RF+) - (RF-)) *	$\Delta\text{Gd1}$	100kHz to 70MHz	—	0.9	—	ns
Group delay difference 2 (A to D) *	$\Delta\text{Gd2}$	100kHz to 90MHz	—	1.0	—	ns
Group delay difference 2 (WPP1, WPP2) *	$\Delta\text{Gd2}$	100kHz to 90MHz	—	1.8	—	ns
Group delay difference 2 ((RF+) - (RF-)) *	$\Delta\text{Gd2}$	100kHz to 90MHz	—	1.0	—	ns
Slew rate (A to D) *	SR	Calculated at 10% to 90%	—	250	—	V/ $\mu\text{s}$
Slew rate (E+I to H+L) *	SR	Calculated at 10% to 90%	—	170	—	V/ $\mu\text{s}$
Slew rate (RF+, RF-) *	SR	Calculated at 10% to 90%	—	225	—	V/ $\mu\text{s}$
Output noise level (A to D) *	$V_n$	RBW = 30kHz, f = 1 to 90MHz, In the dark	—	-87	-82	dBm
Output noise level (RF+, RF-) *	$V_n$	RBW = 30kHz, f = 1 to 90MHz, In the dark	—	-81	-75	dBm

- Note) 1. Output offset voltage:  $V_c$  is the reference.  
2. The output voltage represents the potential variation of the output pin between the optical emission and the dark state.  
3. Items with an asterisk (\*) are design confirmation items.  
4. Measurement by optical input: Measurement is made by emitting light to the center of each photodiode.  
5. The load conditions (for  $V_c$ ) are as follows.  
A to D:  $2\text{k}\Omega//20\text{pF}$ , E+I to H+L, WPP1, WPP2:  $6\text{k}\Omega//20\text{pF}$ , RF+, RF-:  $(1\mu\text{F} + (1.3\text{k}\Omega//10\text{pF}))/10\text{pF}$



## Electrical and Optical Characteristics 2 (Mode-2: Read Mode/High Gain)

(V<sub>CC</sub> = 5.0V, V<sub>C</sub> = 1.4V, V<sub>sw1</sub> = 0V, V<sub>sw2</sub> = 3.3V, T<sub>a</sub> = 25°C)

Item	Symbol	Conditions	Min.	Typ.	Max.	Unit
Current consumption	I <sub>CC</sub>	In the dark	—	44.0	57.5	mA
Output offset voltage (A to D)	V <sub>off</sub>	In the dark, V <sub>C</sub> reference	-30	0	30	mV
Output offset voltage (E+I to H+L)	V <sub>off</sub>	In the dark, V <sub>C</sub> reference	-35	0	35	mV
Output offset voltage (WPP1, WPP2)	V <sub>off</sub>	In the dark, V <sub>C</sub> reference	-30	0	30	mV
Output offset voltage (RF+)	V <sub>off</sub>	In the dark, V <sub>C</sub> reference	-110	0	110	mV
Output offset voltage (RF-)	V <sub>off</sub>	In the dark, V <sub>CC</sub> - V <sub>C</sub> reference	-110	0	110	mV
Output offset matrix	ΔV <sub>off</sub>	(A + B) - (C + D), In the dark	-30	0	30	mV
		(A + D) - (B + C), In the dark	-30	0	30	mV
		(A + C) - (B + D), In the dark	-30	0	30	mV
		(G + H + K + L) - (E + F + I + J), In the dark	-30	0	30	mV
		A + B + C + D, In the dark	-50	0	50	mV
		E + F + G + H + I + J + K + L, In the dark	-50	0	50	mV
		(RF+) - (RF-), In the dark	-160	0	160	mV
Offset temperature drift (A to D) *	ΔV <sub>off</sub> /T	In the dark	-100	0	100	μV/°C
Offset temperature drift (E+I to H+L) *	ΔV <sub>off</sub> /T	In the dark	-150	0	150	μV/°C
Offset temperature drift (WPP1, WPP2) *	ΔV <sub>off</sub> /T	In the dark	-100	0	100	μV/°C
Offset temperature drift (RF+, RF-) *	ΔV <sub>off</sub> /T	In the dark	-1	0	1	mV/°C
Output voltage (A to D) *	V <sub>o</sub>	λ = 650nm, 780nm, P <sub>o</sub> = 10μW	16.8	22.4	28.0	mV/μW
Output voltage (E+I to H+L) *	V <sub>o</sub>	λ = 650nm, 780nm, P <sub>o</sub> = 10μW	67.5	90.0	112.5	mV/μW
Output voltage (WPP1, WPP2) *	V <sub>o</sub>	λ = 650nm, 780nm, P <sub>o</sub> = 10μW	2.79	3.73	4.67	mV/μW
Output voltage (RF+) *	V <sub>o</sub>	λ = 650nm, 780nm, P <sub>o</sub> = 10μW	15.0	20.1	25.1	mV/μW
Output voltage (RF-) *	V <sub>o</sub>	λ = 650nm, 780nm, P <sub>o</sub> = 10μW	-25.1	-20.1	-15.0	mV/μW
Output voltage ratio (E+I to H+L)/(A to D) *	V <sub>OR</sub>	λ = 650nm, 780nm, P <sub>o</sub> = 10μW	3.88	4.08	4.28	—
Output voltage ratio ((RF+) + (RF-))/(A to D) *	V <sub>OR</sub>	λ = 650nm, 780nm, P <sub>o</sub> = 10μW	1.79	1.88	1.97	—
Maximum output potential (A to D, E+I to H+L)	V <sub>omax</sub>	λ = 650nm, 780nm, P <sub>o</sub> = 1mW	3.8	4.0	—	V

Item	Symbol	Conditions	Min.	Typ.	Max.	Unit
Maximum output potential (WPP1, WPP2)	Vomax	$\lambda = 650\text{nm}, 780\text{nm}, P_o = 1\text{mW}$	2.0	2.2	—	V
Maximum output potential (RF+)	Vomax	$\lambda = 650\text{nm}, 780\text{nm}, P_o = 1\text{mW}$	3.8	4.0	—	V
Minimum output potential (RF-)	Vomin	$\lambda = 650\text{nm}, 780\text{nm}, P_o = 1\text{mW}$	—	1.0	1.2	V
Frequency response (A to D) *	fc	$\lambda = 650\text{nm}, 780\text{nm}$ $P_o = 10\mu\text{W}_{\text{DC}} + 4\mu\text{W}_{\text{p-p}}$ 100kHz reference, -3dB	90	120	—	MHz
Frequency response (E+I to H+L) *	fc	$\lambda = 650\text{nm}, 780\text{nm}$ $P_o = 10\mu\text{W}_{\text{DC}} + 4\mu\text{W}_{\text{p-p}}$ 100kHz reference, -3dB	20	30	—	MHz
Frequency response (WPP1, WPP2) *	fc	$\lambda = 650\text{nm}, 780\text{nm}$ $P_o = 10\mu\text{W}_{\text{DC}} + 4\mu\text{W}_{\text{p-p}}$ 100kHz reference, -3dB	90	120	—	MHz
Frequency response ((RF+) - (RF-)) *	fc	$\lambda = 650\text{nm}, 780\text{nm}$ $P_o = 10\mu\text{W}_{\text{DC}} + 4\mu\text{W}_{\text{p-p}}$ 100kHz reference, -3dB	90	120	—	MHz
Group delay difference 1 (A to D) *	$\Delta\text{Gd1}$	100kHz to 70MHz	—	1.2	—	ns
Group delay difference 1 (WPP1, WPP2) *	$\Delta\text{Gd1}$	100kHz to 70MHz	—	1.2	—	ns
Group delay difference 1 ((RF+) - (RF-)) *	$\Delta\text{Gd1}$	100kHz to 70MHz	—	1.0	—	ns
Group delay difference 2 (A to D) *	$\Delta\text{Gd2}$	100kHz to 90MHz	—	1.5	—	ns
Group delay difference 2 (WPP1, WPP2) *	$\Delta\text{Gd2}$	100kHz to 90MHz	—	1.8	—	ns
Group delay difference 2 ((RF+) - (RF-)) *	$\Delta\text{Gd2}$	100kHz to 90MHz	—	1.0	—	ns
Slew rate (A to D) *	SR	Calculated at 10% to 90%	—	250	—	V/ $\mu\text{s}$
Slew rate (E+I to H+L) *	SR	Calculated at 10% to 90%	—	180	—	V/ $\mu\text{s}$
Slew rate (RF+, RF-) *	SR	Calculated at 10% to 90%	—	225	—	V/ $\mu\text{s}$
Output noise level (A to D) *	$V_n$	RBW = 30kHz, f = 1 to 90MHz, In the dark	—	-80	-75	dBm
Output noise level (RF+, RF-) *	$V_n$	RBW = 30kHz, f = 1 to 90MHz, In the dark	—	-74	-69	dBm

- Note) 1. Output offset voltage:  $V_c$  is the reference.  
2. The output voltage represents the potential variation of the output pin between the optical emission and the dark state.  
3. Items with an asterisk (\*) are design confirmation items.  
4. Measurement by optical input: Measurement is made by emitting light to the center of each photodiode.  
5. The load conditions (for  $V_c$ ) are as follows.  
A to D:  $2\text{k}\Omega//20\text{pF}$ , E+I to H+L, WPP1, WPP2:  $6\text{k}\Omega//20\text{pF}$ , RF+, RF-:  $(1\mu\text{F} + (1.3\text{k}\Omega//10\text{pF}))/10\text{pF}$

### Electrical and Optical Characteristics 3 (Mode-3: Write Mode)

(V<sub>CC</sub> = 5.0V, V<sub>C</sub> = 1.4V, V<sub>sw1</sub> = 1.65V, V<sub>sw2</sub> = 1.65V, T<sub>a</sub> = 25°C)

Item	Symbol	Conditions	Min.	Typ.	Max.	Unit
Current consumption	I <sub>CC</sub>	In the dark	—	39.0	51.0	mA
Output offset voltage (A to D)	V <sub>off</sub>	In the dark, V <sub>C</sub> reference	-30	0	30	mV
Output offset voltage (E+I to H+L)	V <sub>off</sub>	In the dark, V <sub>C</sub> reference	-35	0	35	mV
Output offset voltage (WPP1, WPP2)	V <sub>off</sub>	In the dark, V <sub>C</sub> reference	-30	0	30	mV
Output offset matrix	ΔV <sub>off</sub>	(A + B) - (C + D), In the dark	-30	0	30	mV
		(A + D) - (B + C), In the dark	-30	0	30	mV
		(A + C) - (B + D), In the dark	-30	0	30	mV
		(G + H + K + L) - (E + F + I + J), In the dark	-30	0	30	mV
		A + B + C + D, In the dark	-50	0	50	mV
		E + F + G + H + I + J + K + L, In the dark	-50	0	50	mV
Offset temperature drift (A to D) *	ΔV <sub>off</sub> /T	In the dark	-100	0	100	μV/°C
Offset temperature drift (E+I to H+L) *	ΔV <sub>off</sub> /T	In the dark	-150	0	150	μV/°C
Offset temperature drift (WPP1, WPP2) *	ΔV <sub>off</sub> /T	In the dark	-100	0	100	μV/°C
Output voltage (A to D)	V <sub>o</sub>	λ = 650nm, 780nm, P <sub>o</sub> = 350μW	0.98	1.30	1.63	mV/μW
Output voltage (E+I to H+L)	V <sub>o</sub>	λ = 650nm, 780nm, P <sub>o</sub> = 350μW	3.92	5.23	6.54	mV/μW
Output voltage (WPP1, WPP2)	V <sub>o</sub>	λ = 650nm, 780nm, P <sub>o</sub> = 350μW	0.65	0.87	1.09	mV/μW
Output voltage ratio (E+I to H+L)/(A to D)	V <sub>OR</sub>	λ = 650nm, 780nm, P <sub>o</sub> = 350μW	3.89	4.09	4.29	—
Maximum output potential (A to D, E+I to H+L, WPP1, WPP2)	V <sub>omax</sub>	λ = 650nm, 780nm, P <sub>o</sub> = 1mW	3.3	3.5	—	V
Frequency response (A to D) *	f <sub>c</sub>	λ = 650nm, 780nm P <sub>o</sub> = 10μW <sub>DC</sub> + 4μW <sub>p-p</sub> 100kHz reference, -3dB	90	120	—	MHz
Frequency response (E+I to H+L) *	f <sub>c</sub>	λ = 650nm, 780nm P <sub>o</sub> = 10μW <sub>DC</sub> + 4μW <sub>p-p</sub> 100kHz reference, -3dB	25	60	—	MHz
Frequency response (WPP1, WPP2) *	f <sub>c</sub>	λ = 650nm, 780nm P <sub>o</sub> = 10μW <sub>DC</sub> + 4μW <sub>p-p</sub> 100kHz reference, -3dB	100	130	—	MHz

Item	Symbol	Conditions	Min.	Typ.	Max.	Unit
Group delay difference 1 (A to D, WPP1, WPP2) *	$\Delta Gd1$	100kHz to 70MHz	—	1.0	—	ns
Group delay difference 2 (A to D, WPP1, WPP2) *	$\Delta Gd2$	100kHz to 90MHz	—	1.9	—	ns
Settling time (A to D) *	Tset	Output 299mV $\rightarrow$ $15 \pm 3$ mV	—	18.0	—	ns
Settling time (E+I to H+L) *	Tset	Output 323mV $\rightarrow$ $6.5 \pm 1.3$ mV	—	27.0	—	ns
Settling time (WPP1, WPP2) *	Tset	Output 20mV $\rightarrow$ $399 \pm 4$ mV	—	15.0	—	ns
Settling time (WPP1, WPP2) *	Tset	Output 399mV $\rightarrow$ $20 \pm 4$ mV	—	15.0	—	ns
Slew rate (A to D) *	SR	Calculated at 10% to 90%	—	210	—	V/ $\mu$ s
Slew rate (E+I to H+L) *	SR	Calculated at 10% to 90%	—	200	—	V/ $\mu$ s
Slew rate (WPP1, WPP2) *	SR	Calculated at 10% to 90%	—	260	—	V/ $\mu$ s
Output noise level (A to D) *	Vn	RBW = 30kHz, f = 1 to 90MHz, In the dark	—	-93	-88	dBm
Output noise level (WPP1, WPP2) *	Vn	RBW = 30kHz, f = 1 to 90MHz, In the dark	—	-89	-84	dBm

- Note) 1. Output offset voltage: V<sub>c</sub> is the reference.  
2. The output voltage represents the potential variation of the output pin between the optical emission and the dark state.  
3. Items with an asterisk (\*) are design confirmation items.  
4. Measurement by optical input: Measurement is made by emitting light to the center of each photodiode.  
5. The load conditions (for V<sub>c</sub>) are as follows.  
A to D: 2k $\Omega$ //20pF, E+I to H+L, WPP1, WPP2: 6k $\Omega$ //20pF

### Electrical and Optical Characteristics 4 (Mode-4: Write Mode)

(V<sub>CC</sub> = 5.0V, V<sub>C</sub> = 1.4V, V<sub>sw1</sub> = 1.65V, V<sub>sw2</sub> = 3.3V, T<sub>a</sub> = 25°C)

Item	Symbol	Conditions	Min.	Typ.	Max.	Unit
Current consumption	I <sub>CC</sub>	In the dark	—	39.0	51.0	mA
Output offset voltage (A to D)	V <sub>off</sub>	In the dark, V <sub>C</sub> reference	-30	0	30	mV
Output offset voltage (E+I to H+L)	V <sub>off</sub>	In the dark, V <sub>C</sub> reference	-35	0	35	mV
Output offset voltage (WPP1, WPP2)	V <sub>off</sub>	In the dark, V <sub>C</sub> reference	-30	0	30	mV
Output offset matrix	ΔV <sub>off</sub>	(A + B) - (C + D), In the dark	-30	0	30	mV
		(A + D) - (B + C), In the dark	-30	0	30	mV
		(A + C) - (B + D), In the dark	-30	0	30	mV
		(G + H + K + L) - (E + F + I + J), In the dark	-30	0	30	mV
		A + B + C + D, In the dark	-50	0	50	mV
		E + F + G + H + I + J + K + L, In the dark	-50	0	50	mV
Offset temperature drift (A to D) *	ΔV <sub>off</sub> /T	In the dark	-100	0	100	μV/°C
Offset temperature drift (E+I to H+L) *	ΔV <sub>off</sub> /T	In the dark	-150	0	150	μV/°C
Offset temperature drift (WPP1, WPP2) *	ΔV <sub>off</sub> /T	In the dark	-100	0	100	μV/°C
Output voltage (A to D)	V <sub>o</sub>	λ = 650nm, 780nm, P <sub>o</sub> = 175μW	2.73	2.91	3.41	mV/μW
Output voltage (E+I to H+L)	V <sub>o</sub>	λ = 650nm, 780nm, P <sub>o</sub> = 175μW	8.78	11.71	14.63	mV/μW
Output voltage (WPP1, WPP2)	V <sub>o</sub>	λ = 650nm, 780nm, P <sub>o</sub> = 175μW	1.46	1.95	2.44	mV/μW
Output voltage ratio (E+I to H+L)/(A to D)	V <sub>OR</sub>	λ = 650nm, 780nm, P <sub>o</sub> = 175μW	3.78	3.98	4.18	—
Maximum output potential (A to D, E+I to H+L, WPP1, WPP2)	V <sub>omax</sub>	λ = 650nm, 780nm, P <sub>o</sub> = 1mW	3.5	3.7	—	V
Frequency response (A to D) *	f <sub>c</sub>	λ = 650nm, 780nm P <sub>o</sub> = 10μW <sub>DC</sub> + 4μW <sub>p-p</sub> 100kHz reference, -3dB	90	120	—	MHz
Frequency response (E+I to H+L) *	f <sub>c</sub>	λ = 650nm, 780nm P <sub>o</sub> = 10μW <sub>DC</sub> + 4μW <sub>p-p</sub> 100kHz reference, -3dB	30	50	—	MHz
Frequency response (WPP1, WPP2) *	f <sub>c</sub>	λ = 650nm, 780nm P <sub>o</sub> = 10μW <sub>DC</sub> + 4μW <sub>p-p</sub> 100kHz reference, -3dB	100	130	—	MHz

Item	Symbol	Conditions	Min.	Typ.	Max.	Unit
Group delay difference 1 (A to D, WPP1, WPP2) *	$\Delta Gd1$	100kHz to 70MHz	—	1.4	—	ns
Group delay difference 2 (A to D, WPP1, WPP2) *	$\Delta Gd2$	100kHz to 90MHz	—	2.4	—	ns
Settling time (A to D) *	Tset	Output 690mV $\rightarrow$ 34.5 $\pm$ 6.9mV	—	18.0	—	ns
Settling time (E+I to H+L) *	Tset	Output 745mV $\rightarrow$ 14.9 $\pm$ 3mV	—	27.0	—	ns
Settling time (WPP1, WPP2) *	Tset	Output 920mV $\rightarrow$ 46 $\pm$ 9.2mV	—	15.0	—	ns
Settling time (WPP1, WPP2) *	Tset	Output 46mV $\rightarrow$ 920 $\pm$ 9.2mV	—	15.0	—	ns
Slew rate (A to D) *	SR	Calculated at 10% to 90%	—	250	—	V/ $\mu$ s
Slew rate (E+I to H+L) *	SR	Calculated at 10% to 90%	—	200	—	V/ $\mu$ s
Slew rate (WPP1, WPP2) *	SR	Calculated at 10% to 90%	—	260	—	V/ $\mu$ s
Output noise level (A to D) *	Vn	RBW = 30kHz, f = 1 to 90MHz, In the dark	—	-87	-82	dBm
Output noise level (WPP1, WPP2) *	Vn	RBW = 30kHz, f = 1 to 90MHz, In the dark	—	-85	-80	dBm

- Note) 1. Output offset voltage: Vc is the reference.  
2. The output voltage represents the potential variation of the output pin between the optical emission and the dark state.  
3. Items with an asterisk (\*) are design confirmation items.  
4. Measurement by optical input: Measurement is made by emitting light to the center of each photodiode.  
5. The load conditions (for Vc) are as follows.  
A to D: 2k $\Omega$ //20pF, E+I to H+L, WPP1, WPP2: 6k $\Omega$ //20pF

### Electrical and Optical Characteristics 5 (Mode-5: Write Mode)

( $V_{CC} = 5.0V$ ,  $V_C = 1.4V$ ,  $V_{sw1} = 3.3V$ ,  $V_{sw2} = 1.65V$ ,  $T_a = 25^\circ C$ )

Item	Symbol	Conditions	Min.	Typ.	Max.	Unit
Current consumption	$I_{CC}$	In the dark	—	39.0	51.0	mA
Output offset voltage (A to D)	$V_{off}$	In the dark, $V_C$ reference	-30	0	30	mV
Output offset voltage (E+I to H+L)	$V_{off}$	In the dark, $V_C$ reference	-35	0	35	mV
Output offset voltage (WPP1, WPP2)	$V_{off}$	In the dark, $V_C$ reference	-30	0	30	mV
Output offset matrix	$\Delta V_{off}$	(A + B) - (C + D), In the dark	-30	0	30	mV
		(A + D) - (B + C), In the dark	-30	0	30	mV
		(A + C) - (B + D), In the dark	-30	0	30	mV
		(G + H + K + L) - (E + F + I + J), In the dark	-30	0	30	mV
		A + B + C + D, In the dark	-50	0	50	mV
		E + F + G + H + I + J + K + L, In the dark	-50	0	50	mV
Offset temperature drift (A to D) *	$\Delta V_{off}/T$	In the dark	-100	0	100	$\mu V/^\circ C$
Offset temperature drift (E+I to H+L) *	$\Delta V_{off}/T$	In the dark	-150	0	150	$\mu V/^\circ C$
Offset temperature drift (WPP1, WPP2) *	$\Delta V_{off}/T$	In the dark	-1	0	1	mV/°C
Output voltage (A to D)	$V_o$	$\lambda = 650nm, 780nm, P_o = 350\mu W$	0.75	1.00	1.25	mV/ $\mu W$
Output voltage (E+I to H+L)	$V_o$	$\lambda = 650nm, 780nm, P_o = 350\mu W$	3.01	4.02	5.03	mV/ $\mu W$
Output voltage (WPP1, WPP2)	$V_o$	$\lambda = 650nm, 780nm, P_o = 350\mu W$	0.50	0.67	0.84	mV/ $\mu W$
Output voltage ratio (E+I to H+L)/(A to D)	$V_{OR}$	$\lambda = 650nm, 780nm, P_o = 350\mu W$	3.95	4.16	4.37	—
Maximum output potential (A to D, E+I to H+L, WPP1, WPP2)	$V_{omax}$	$\lambda = 650nm, 780nm, P_o = 1mW$	3.3	3.5	—	V
Frequency response (A to D) *	$f_c$	$\lambda = 650nm, 780nm$ $P_o = 10\mu W_{DC} + 4\mu W_{p-p}$ 100kHz reference, -3dB	90	120	—	MHz
Frequency response (E+I to H+L) *	$f_c$	$\lambda = 650nm, 780nm$ $P_o = 10\mu W_{DC} + 4\mu W_{p-p}$ 100kHz reference, -3dB	50	75	—	MHz
Frequency response (WPP1, WPP2) *	$f_c$	$\lambda = 650nm, 780nm$ $P_o = 10\mu W_{DC} + 4\mu W_{p-p}$ 100kHz reference, -3dB	95	150	—	MHz

Item	Symbol	Conditions	Min.	Typ.	Max.	Unit
Group delay difference 1 (A to D, WPP1, WPP2) *	$\Delta Gd1$	100kHz to 70MHz	—	1.4	—	ns
Group delay difference 2 (A to D, WPP1, WPP2) *	$\Delta Gd2$	100kHz to 90MHz	—	2.4	—	ns
Settling time (A to D) *	Tset	Output 230mV $\rightarrow$ $11.5 \pm 2.3$ mV	—	15.0	—	ns
Settling time (E+I to H+L) *	Tset	Output 248mV $\rightarrow$ $5 \pm 1$ mV	—	24.0	—	ns
Settling time (WPP1, WPP2) *	Tset	Output 306.7mV $\rightarrow$ $15.3 \pm 3.1$ mV	—	15.0	—	ns
Settling time (WPP1, WPP2) *	Tset	Output 15.3mV $\rightarrow$ $306.7 \pm 3.1$ mV	—	15.0	—	ns
Slew rate (A to D) *	SR	Calculated at 10% to 90%	—	210	—	V/ $\mu$ s
Slew rate (E+I to H+L) *	SR	Calculated at 10% to 90%	—	200	—	V/ $\mu$ s
Slew rate (WPP1, WPP2) *	SR	Calculated at 10% to 90%	—	260	—	V/ $\mu$ s
Output noise level (A to D) *	Vn	RBW = 30kHz, f = 1 to 90MHz, In the dark	—	-93	-88	dBm
Output noise level (WPP1, WPP2) *	Vn	RBW = 30kHz, f = 1 to 90MHz, In the dark	—	-89	-84	dBm

- Note) 1. Output offset voltage: V<sub>c</sub> is the reference.
2. The output voltage represents the potential variation of the output pin between the optical emission and the dark state.
  3. Items with an asterisk (\*) are design confirmation items.
  4. Measurement by optical input: Measurement is made by emitting light to the center of each photodiode.
  5. The load conditions (for V<sub>c</sub>) are as follows.  
A to D: 2k $\Omega$ //20pF, E+I to H+L, WPP1, WPP2: 6k $\Omega$ //20pF



**Electrical and Optical Characteristics 6 (Mode-6: Write Mode)**

 (V<sub>CC</sub> = 5.0V, V<sub>C</sub> = 1.4V, V<sub>sw1</sub> = 3.3V, V<sub>sw2</sub> = 3.3V, T<sub>a</sub> = 25°C)

Item	Symbol	Conditions	Min.	Typ.	Max.	Unit
Current consumption	I <sub>CC</sub>	In the dark	—	39.0	51.0	mA
Output offset voltage (A to D)	V <sub>off</sub>	In the dark, V <sub>C</sub> reference	-30	0	30	mV
Output offset voltage (E+I to H+L)	V <sub>off</sub>	In the dark, V <sub>C</sub> reference	-35	0	35	mV
Output offset voltage (WPP1, WPP2)	V <sub>off</sub>	In the dark, V <sub>C</sub> reference	-30	0	30	mV
Output offset matrix	ΔV <sub>off</sub>	(A + B) - (C + D), In the dark	-30	0	30	mV
		(A + D) - (B + C), In the dark	-30	0	30	mV
		(A + C) - (B + D), In the dark	-30	0	30	mV
		(G + H + K + L) - (E + F + I + J), In the dark	-30	0	30	mV
		A + B + C + D, In the dark	-50	0	50	mV
		E + F + G + H + I + J + K + L, In the dark	-50	0	50	mV
Offset temperature drift (A to D) *	ΔV <sub>off</sub> /T	In the dark	-100	0	100	μV/°C
Offset temperature drift (E+I to H+L) *	ΔV <sub>off</sub> /T	In the dark	-150	0	150	μV/°C
Offset temperature drift (WPP1, WPP2) *	ΔV <sub>off</sub> /T	In the dark	-100	0	100	μV/°C
Output voltage (A to D)	V <sub>o</sub>	λ = 650nm, 780nm, P <sub>o</sub> = 175μW	1.68	2.24	2.80	mV/μW
Output voltage (E+I to H+L)	V <sub>o</sub>	λ = 650nm, 780nm, P <sub>o</sub> = 175μW	6.75	9.01	11.26	mV/μW
Output voltage (WPP1, WPP2)	V <sub>o</sub>	λ = 650nm, 780nm, P <sub>o</sub> = 175μW	1.12	1.50	1.88	mV/μW
Output voltage ratio (E+I to H+L)/(A to D)	V <sub>OR</sub>	λ = 650nm, 780nm, P <sub>o</sub> = 175μW	3.83	4.03	4.23	—
Maximum output potential (A to D, E+I to H+L, WPP1, WPP2)	V <sub>omax</sub>	λ = 650nm, 780nm, P <sub>o</sub> = 1mW	3.5	3.7	—	V
Frequency response (A to D) *	f <sub>c</sub>	λ = 650nm, 780nm P <sub>o</sub> = 10μW <sub>DC</sub> + 4μW <sub>p-p</sub> 100kHz reference, -3dB	90	120	—	MHz
Frequency response (E+I to H+L) *	f <sub>c</sub>	λ = 650nm, 780nm P <sub>o</sub> = 10μW <sub>DC</sub> + 4μW <sub>p-p</sub> 100kHz reference, -3dB	35	60	—	MHz
Frequency response (WPP1, WPP2) *	f <sub>c</sub>	λ = 650nm, 780nm P <sub>o</sub> = 10μW <sub>DC</sub> + 4μW <sub>p-p</sub> 100kHz reference, -3dB	95	150	—	MHz

Item	Symbol	Conditions	Min.	Typ.	Max.	Unit
Group delay difference 1 (A to D, WPP1, WPP2) *	$\Delta Gd1$	100kHz to 70MHz	—	1.2	—	ns
Group delay difference 2 (A to D, WPP1, WPP2) *	$\Delta Gd2$	100kHz to 90MHz	—	2.3	—	ns
Settling time (A to D) *	Tset	Output 515mV $\rightarrow$ 25.8 $\pm$ 5.2mV	—	15.0	—	ns
Settling time (E+I to H+L) *	Tset	Output 556.6mV $\rightarrow$ 11.1 $\pm$ 2.2mV	—	24.0	—	ns
Settling time (WPP1, WPP2) *	Tset	Output 687mV $\rightarrow$ 34.4 $\pm$ 6.9mV	—	15.0	—	ns
Settling time (WPP1, WPP2) *	Tset	Output 34.4mV $\rightarrow$ 687 $\pm$ 6.9mV	—	15.0	—	ns
Slew rate (A to D) *	SR	Calculated at 10% to 90%	—	250	—	V/ $\mu$ s
Slew rate (E+I to H+L) *	SR	Calculated at 10% to 90%	—	200	—	V/ $\mu$ s
Slew rate (WPP1, WPP2) *	SR	Calculated at 10% to 90%	—	260	—	V/ $\mu$ s
Output noise level (A to D) *	Vn	RBW = 30kHz, f = 1 to 90MHz, In the dark	—	-87	-82	dBm
Output noise level (WPP1, WPP2) *	Vn	RBW = 30kHz, f = 1 to 90MHz, In the dark	—	-85	-80	dBm

- Note) 1. Output offset voltage: Vc is the reference.  
2. The output voltage represents the potential variation of the output pin between the optical emission and the dark state.  
3. Items with an asterisk (\*) are design confirmation items.  
4. Measurement by optical input: Measurement is made by emitting light to the center of each photodiode.  
5. The load conditions (for Vc) are as follows.  
A to D: 2k $\Omega$ //20pF, E+I to H+L, WPP1, WPP2: 6k $\Omega$ //20pF

### Electrical and Optical Characteristics 7 (Read to Write Mode Switching Characteristics)

(V<sub>CC</sub> = 5.0V, V<sub>C</sub> = 1.4V, T<sub>a</sub> = 25°C)

Item	Symbol	Conditions	Min.	Typ.	Max.	Unit
Mode switching time (A to D, RF+, RF-)	Tset	$\lambda = 650\text{nm}, 780\text{nm}, P_o = 5\mu\text{W}$ Output level $\pm 2\%$ (Read mode $\Rightarrow$ Write mode)	—	180	—	ns

### Electrical and Optical Characteristics 8 (Sleep Mode)

(V<sub>CC</sub> = 5.0V, V<sub>C</sub> = 1.4V, V<sub>sw2</sub> = 0V, T<sub>a</sub> = 25°C)

Item	Symbol	Conditions	Min.	Typ.	Max.	Unit
Current consumption	I <sub>cc</sub>	In the dark	—	0.7	1.0	mA

Measurement Circuit

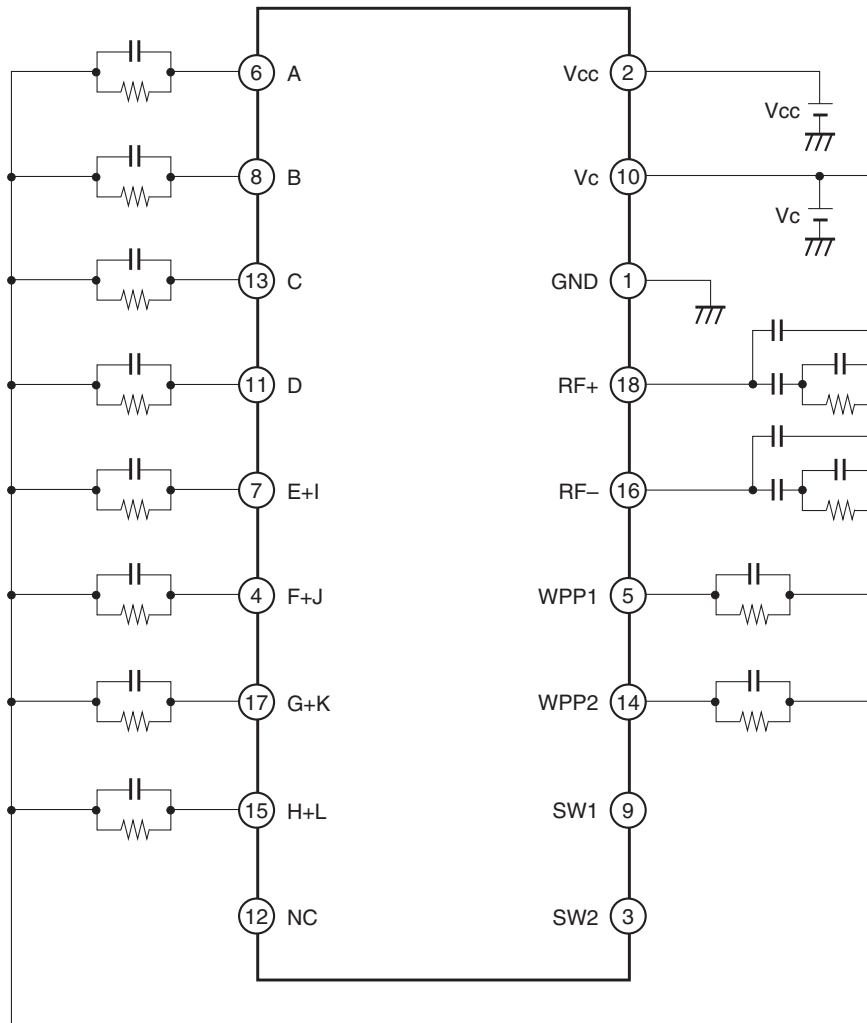

\* The load conditions are as follows.

- A to D :  $2k\Omega/20pF$
- E+I to H+L, WPP1, WPP2 :  $6k\Omega/20pF$
- RF+, RF- :  $(1\mu F + (1.3k\Omega/10pF))/10pF$

**Photodetector Pattern Dimensions**

(Unit:  $\mu\text{m}$ )

\* Division line width:  $4\mu\text{m}$

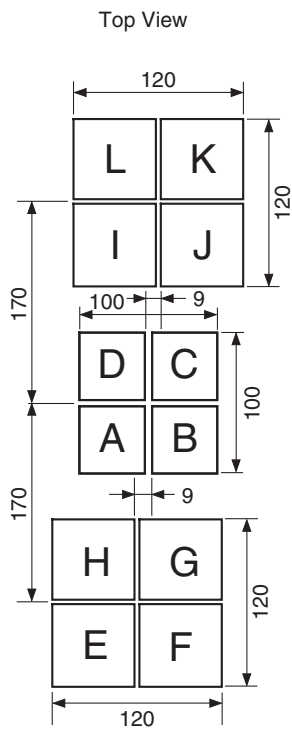

Example of Representative Characteristics (Frequency Response)

Mode-1

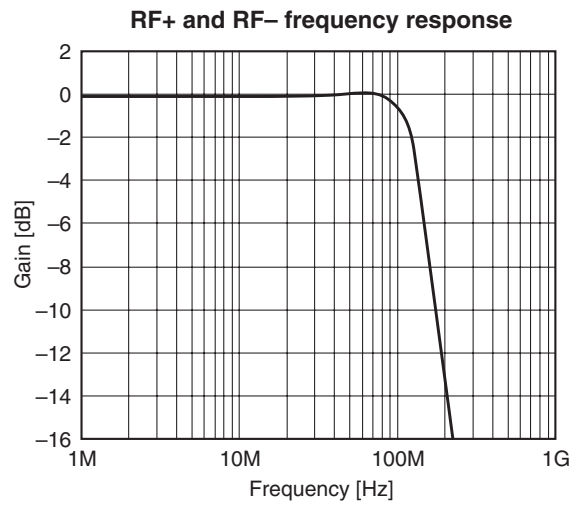
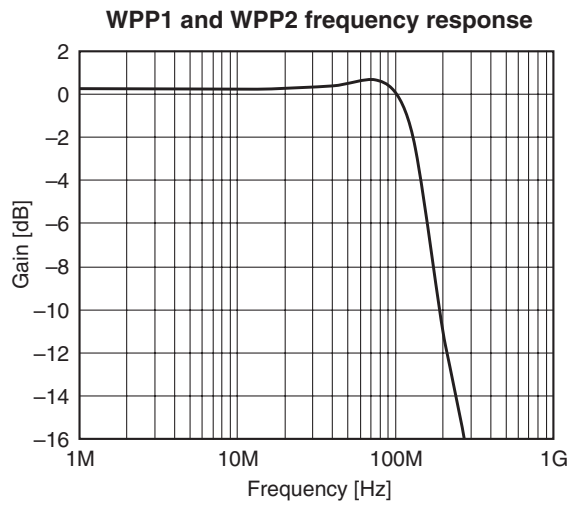
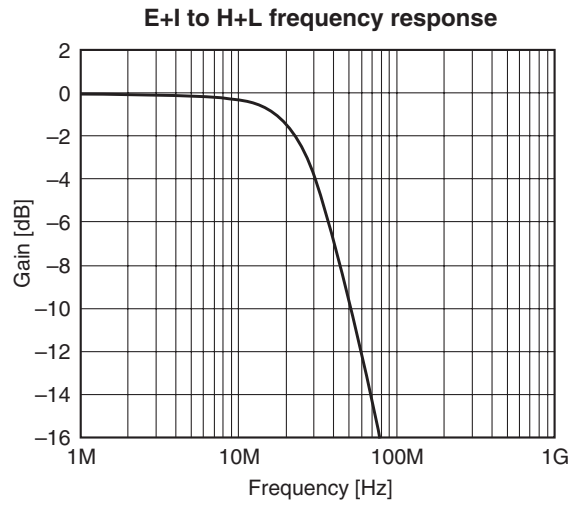
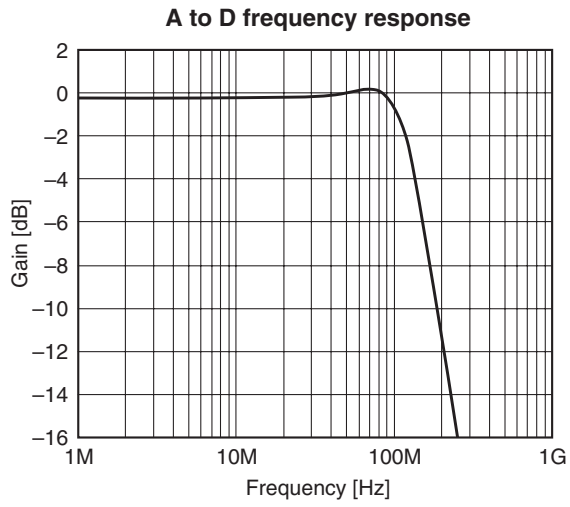

Mode-2

A to D frequency response

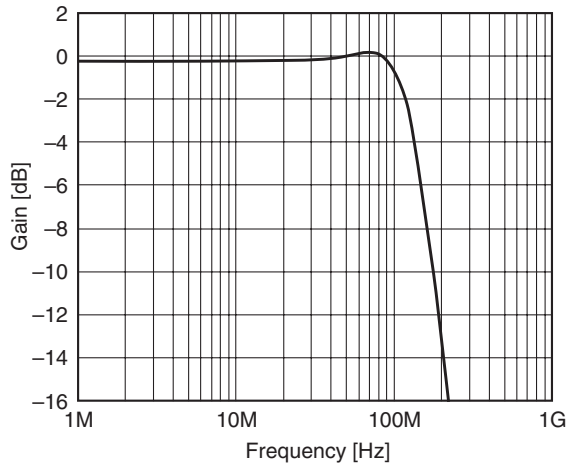

E+I to H+L frequency response

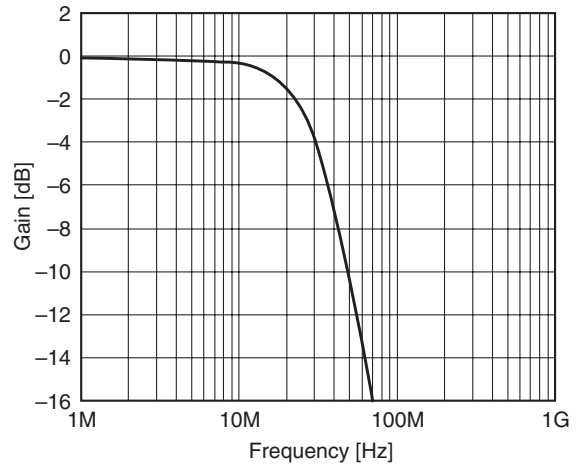

WPP1 and WPP2 frequency response

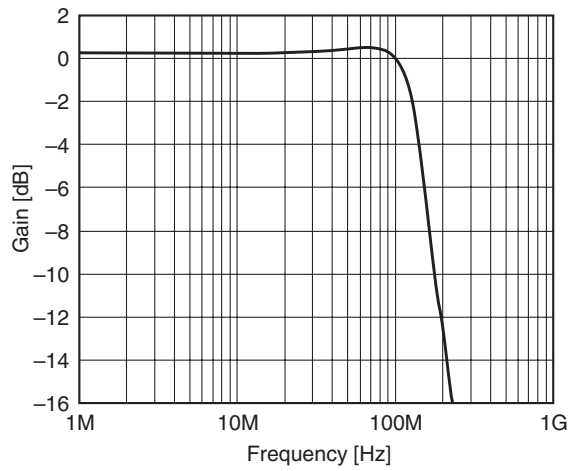

RF+ and RF- frequency response

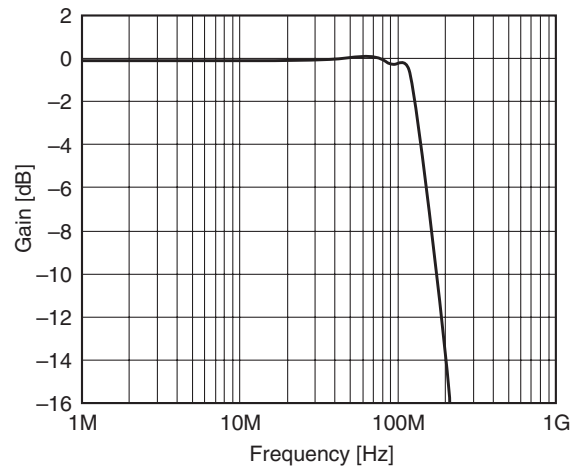

Mode-3

A to D frequency response

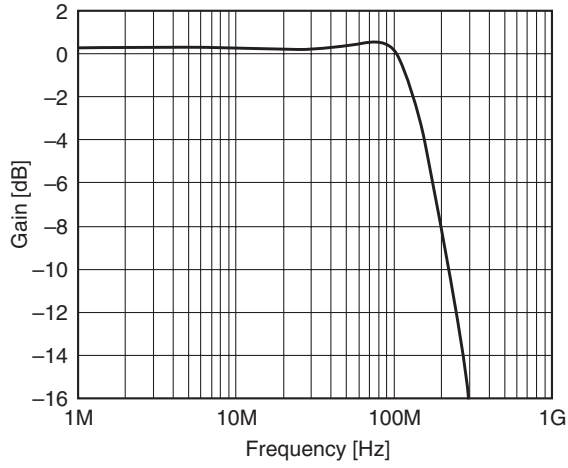

E+I to H+L frequency response

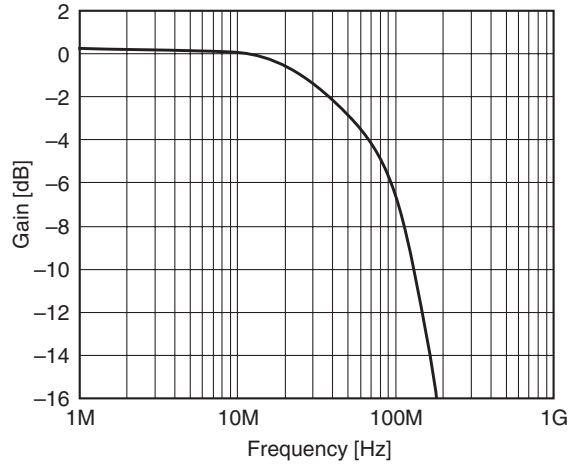

WPP1 and WPP2 frequency response

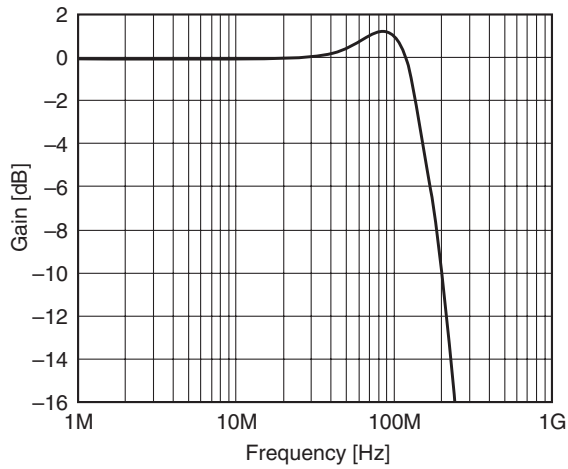



Mode-4

A to D frequency response

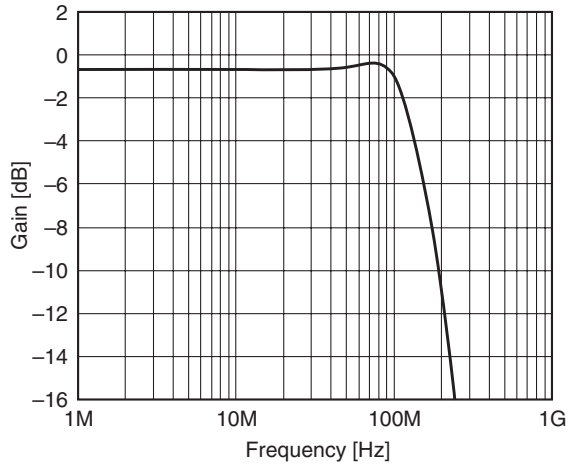

E+I to H+L frequency response

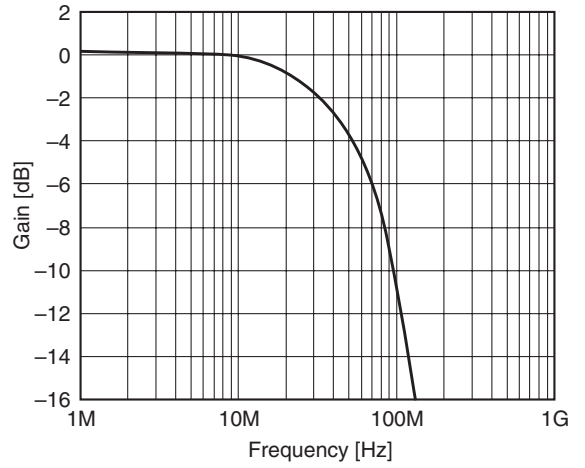

WPP1 and WPP2 frequency response

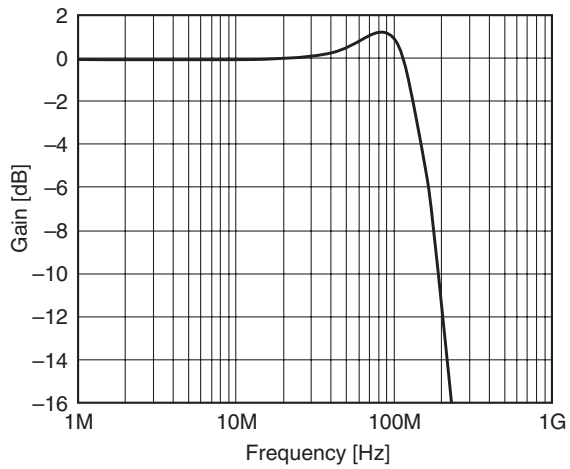

Mode-5

A to D frequency response

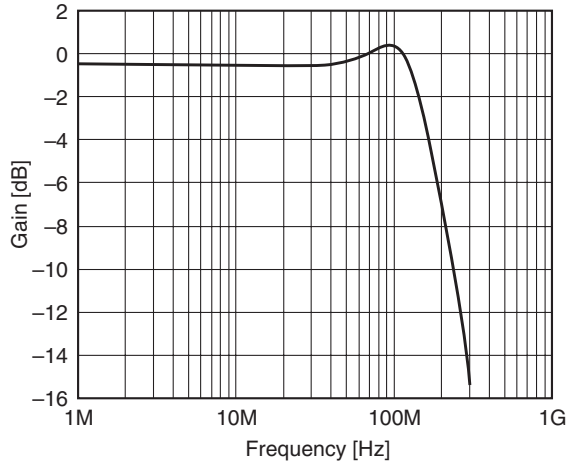

E+I to H+L frequency response

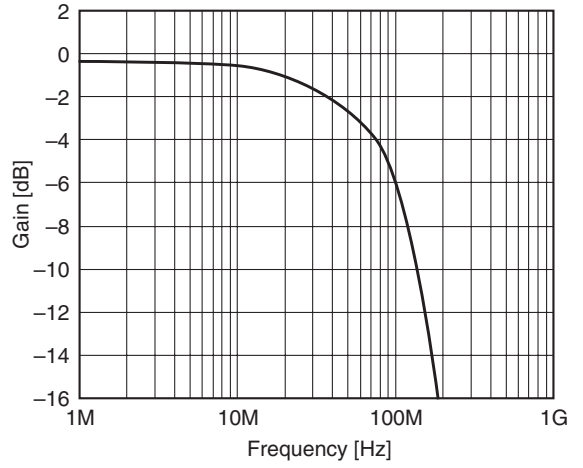

WPP1 and WPP2 frequency response

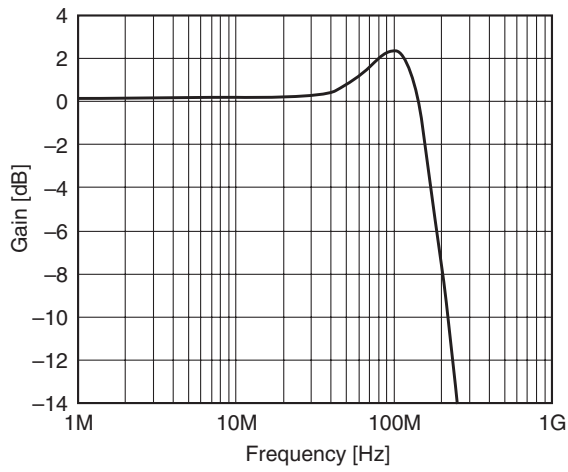

Mode-6

A to D frequency response

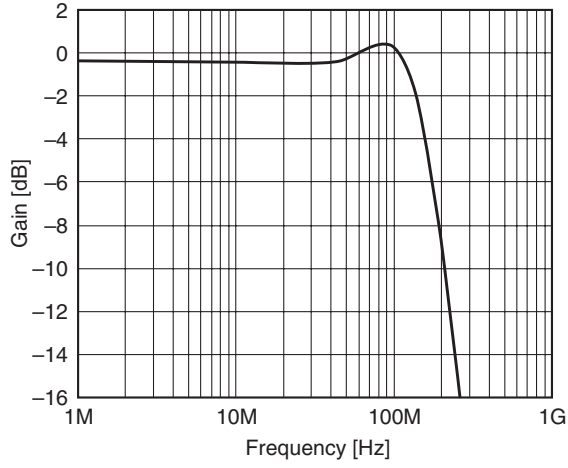

E+I to H+L frequency response

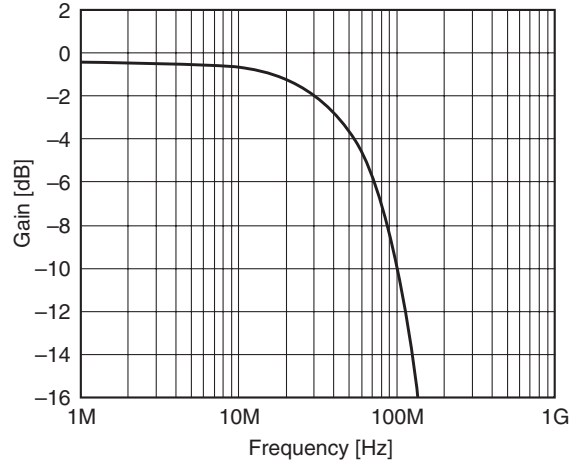

WPP1 and WPP2 frequency response

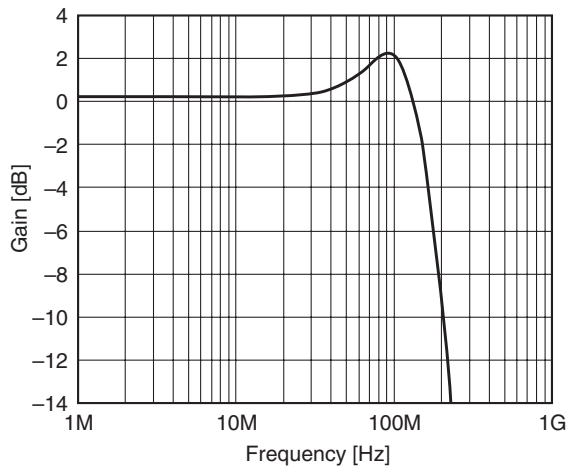



Example of Representative Characteristics (Settling Characteristics)

Mode-3

A to D settling characteristics

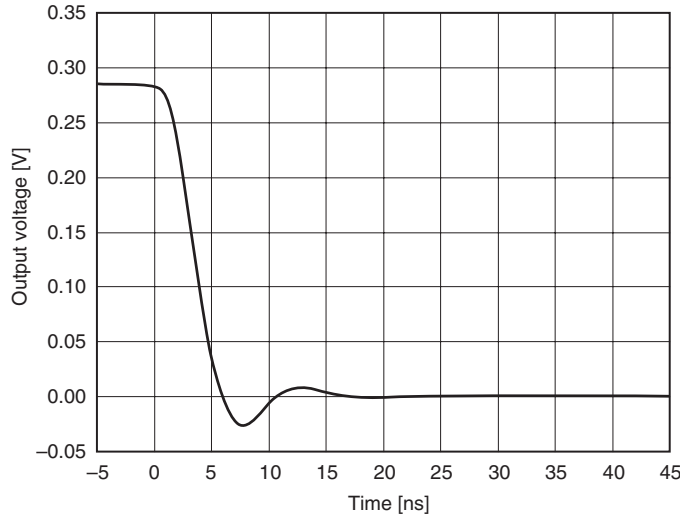

E+I to H+L settling characteristics

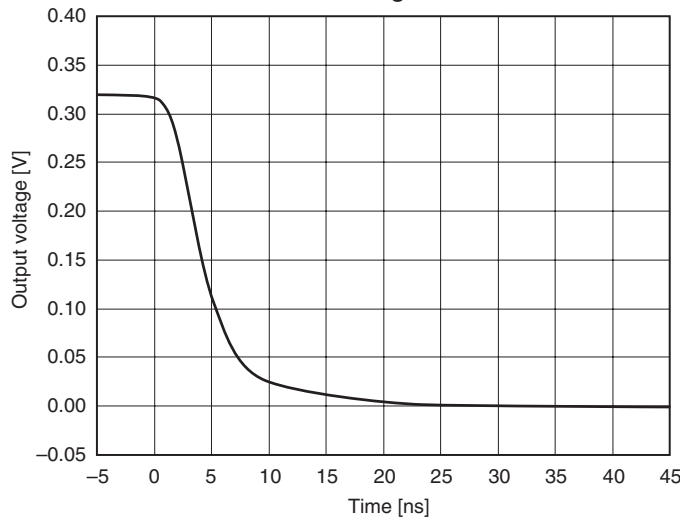

WPP1 and WPP2 settling characteristics

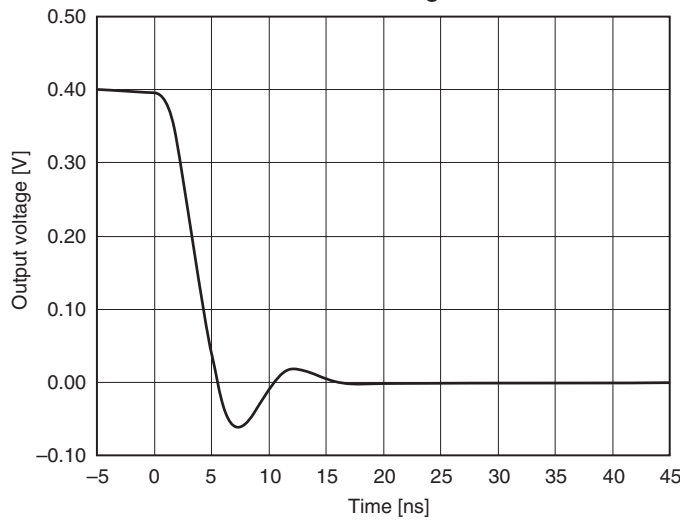

Mode-4

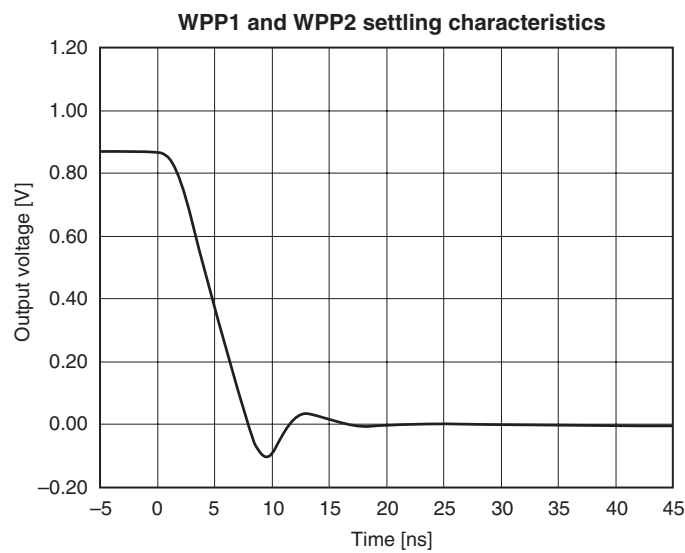
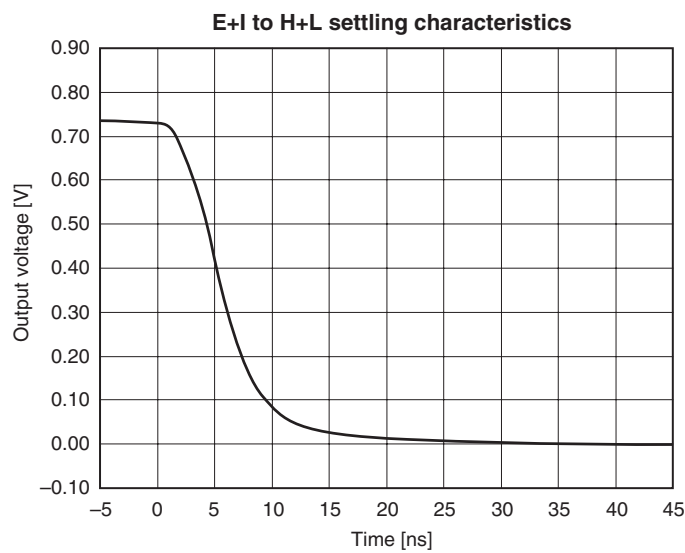
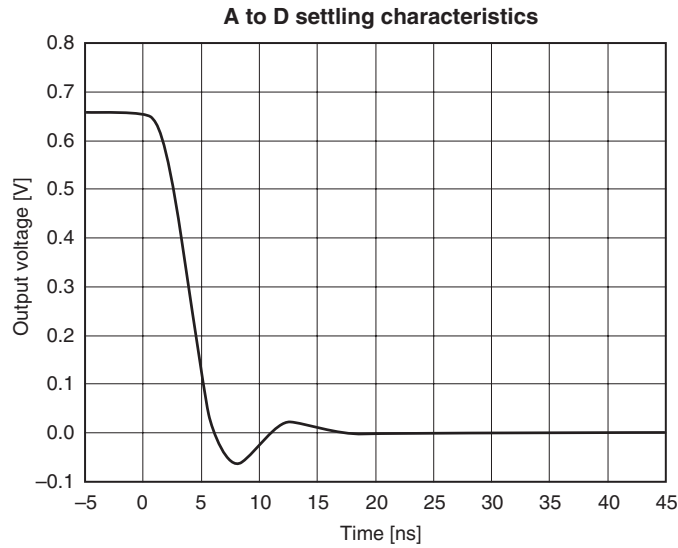

Mode-5

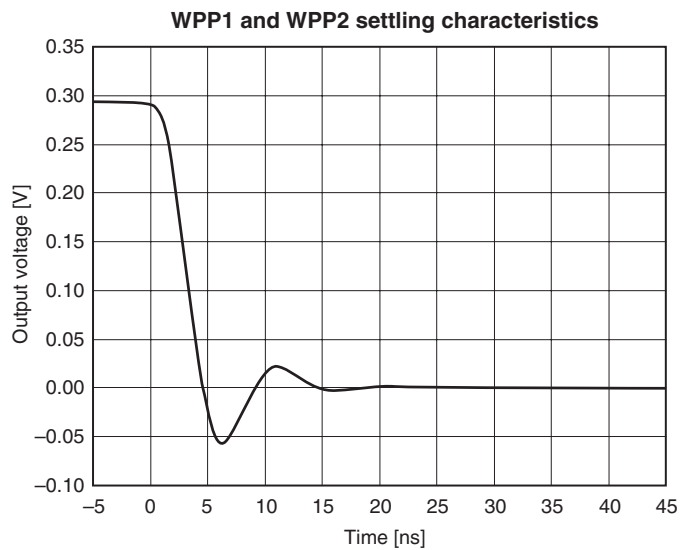
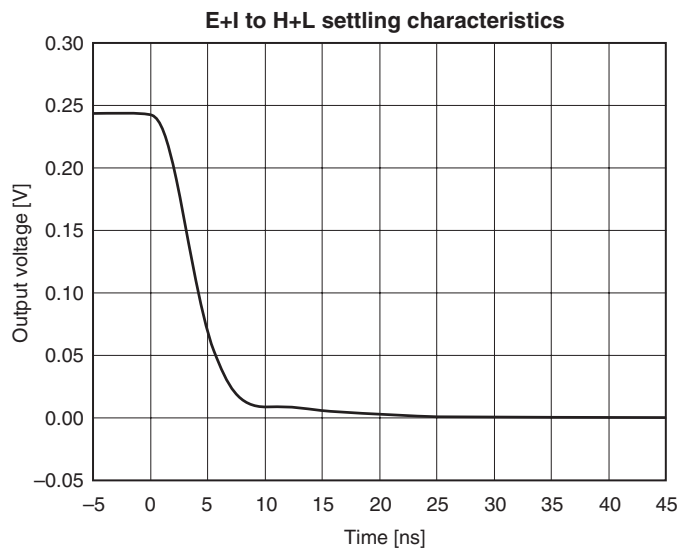
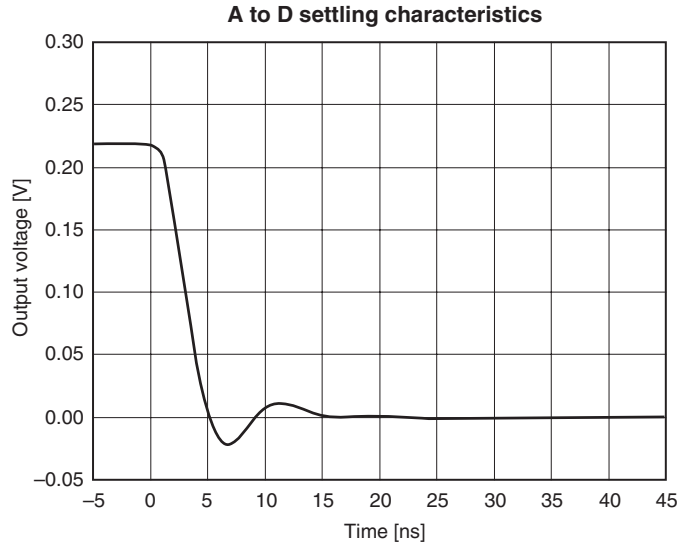

Mode-6

A to D settling characteristics

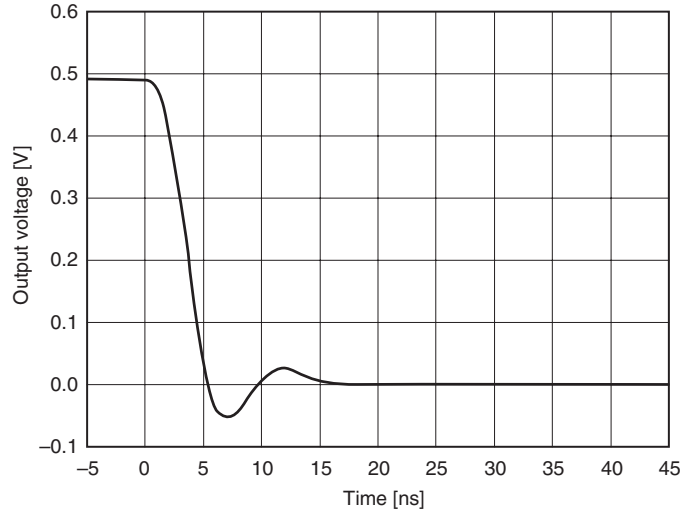

E+I to H+L settling characteristics

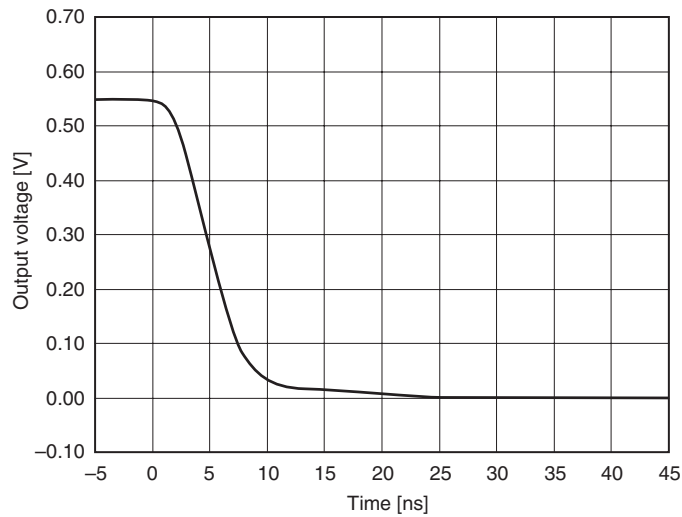

WPP1 and WPP2 settling characteristics

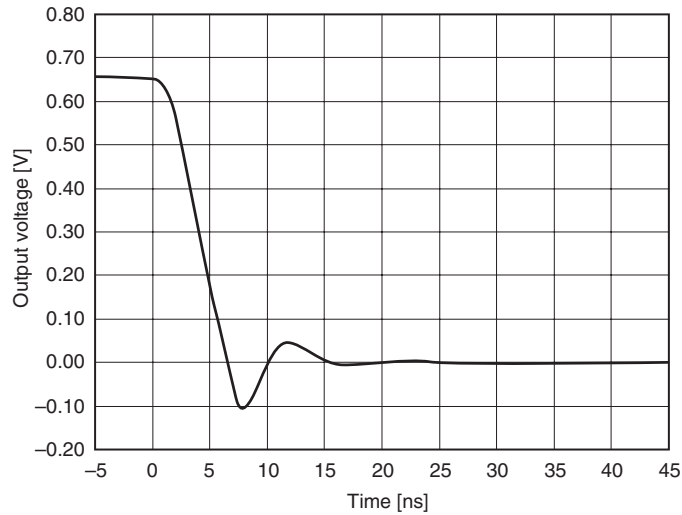

## Notes on Operation

### 1. Power supply

The CXA2726GA can be used with a single power supply or a dual power supply. However, this IC is not provided with a center voltage generating circuit, and so when used with a single power supply the center voltage must be supplied from the RF amplifier or other device.

The power supply connections for each case are shown in the table below.

	Vcc (Pin 2)	Vc (Pin 10)	GND (Pin 1)
Dual power supply	Positive power supply	GND	Negative power supply
Single power supply	Positive power supply	Center voltage	GND

The potential difference between the Vcc pin and the GND pin should be in the range of 4.5 to 5.5V for both a single power supply and a dual power supply.

### 2. Mechanical strength of package

The mechanical strength of the package is not guaranteed for the CXA2726GA. Do not employ a mounting method which applies a heavy load to the package.

### 3. Visual inspection standard

The visual inspection standards over the photodetector are as follows.

- (1) Foreign object limit  
A to L: Equivalent area  $\phi 10\mu\text{m}$  or less
- (2) Inspection method  
Using a metallurgical microscope ( $\times 50$ , coaxial illumination, bright field image), focus on the photodetector and measure the sharp shadow size.
- (3) Inspection range  
Entire photodetector area (entire area of A to L on page 21).

### 4. Bypass capacitors

Connect 0.1 $\mu\text{F}$  capacitors “between the Vcc and Vc pins and between the Vc and GND pins” or “between the Vcc and GND pins and between the Vc and GND pins” to lower the power supply line impedance. Use a flexible printed circuit (FPC) pattern or take other measures so that the bypass capacitors can be located near the PDIC.

### 5. Electrostatic strength

The CXA2726GA has a electrostatic strength of 300V<sup>\*1</sup>, and should be used in an environment where countermeasures against electrostatic discharge have been implemented.

\*1 Testing method: EIAJ ED-4701-1 C-111A Testing method A

### 6. Soldering

Reflow soldering: Finish reflow soldering under the recommended conditions described on the next page. Also, take care not to apply stress to the package during preheating and in the heated condition including immediately after soldering because the resin is softened in these cases.



## Reflow Soldering Recommended Conditions 1

1. Perform infrared or hot air reflow, or use an oven that combines these methods.
2. Finish reflow soldering within the following range after unsealing the moisture-proof packing.

30°C/70%RH/8h → Reflow → 30°C/70%RH/8h → Reflow

Note) Perform reflow soldering a maximum of two times.

When reflow soldering cannot be performed within these specifications, baking should first be performed under either of the following conditions.

[Baking conditions]

- ◆ 125°C, 10 to 48h
- ◆ Baking can be performed in the taped condition.
- ◆ Baking should be performed only one time.

3. Reflow conditions: Perform reflow soldering within the range shown in the figure below.

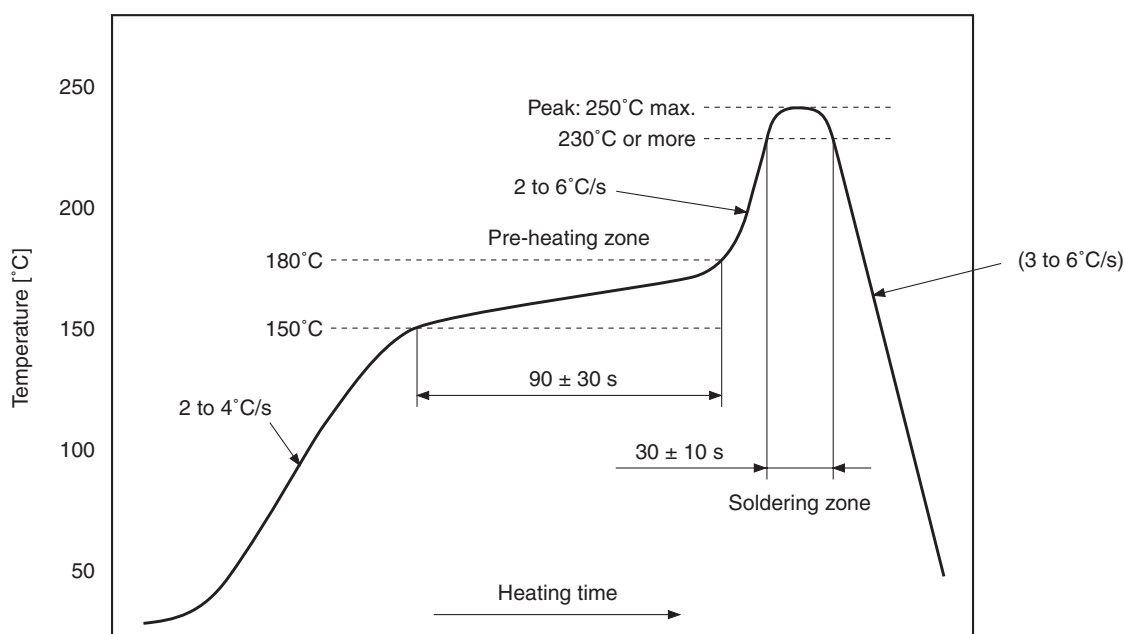

Be sure to consult your Sony representative when performing reflow soldering outside of the ranges described above.

## Reflow Soldering Recommended Conditions 2

1. Perform infrared or hot air reflow, or use an oven that combines these methods.
2. Finish reflow soldering within the following range after unsealing the moisture-proof packing.

30°C/80%RH/12h → Reflow

Note) Perform reflow soldering only one time.

When reflow soldering cannot be performed within these specifications, baking should first be performed under either of the following conditions.

[Baking conditions]

- ◆ 125°C, 10 to 48h
- ◆ Baking can be performed in the taped condition.
- ◆ Baking should be performed only one time.

3. Reflow conditions: Perform reflow soldering within the range shown in the figure below.

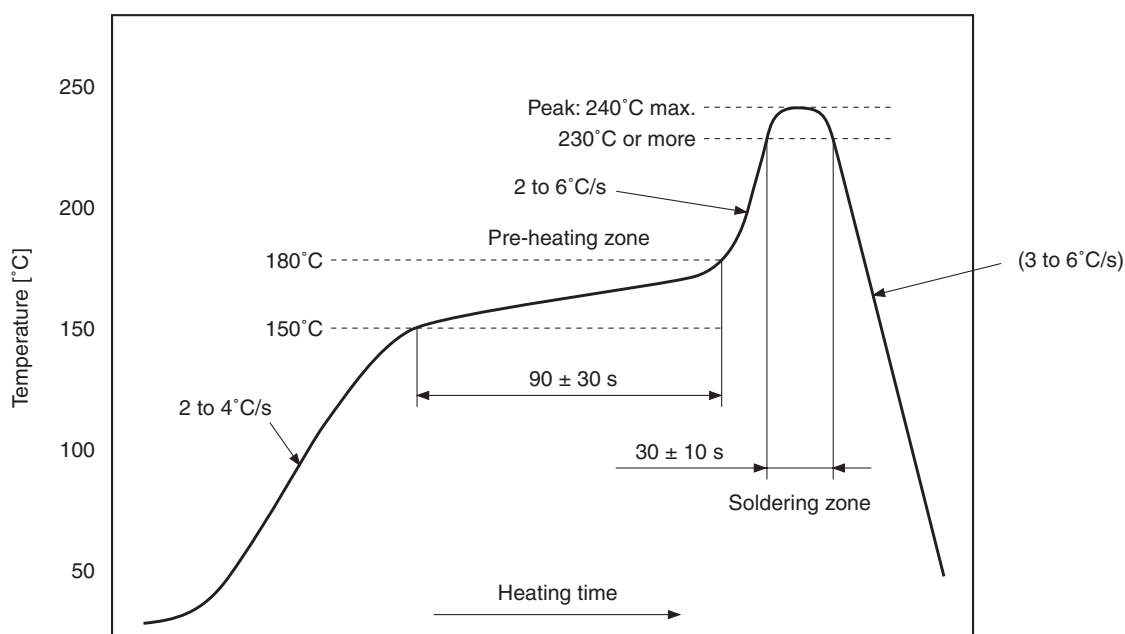

Be sure to consult your Sony representative when performing reflow soldering outside of the ranges described above.

Pin 1 Indication Explanation Figure

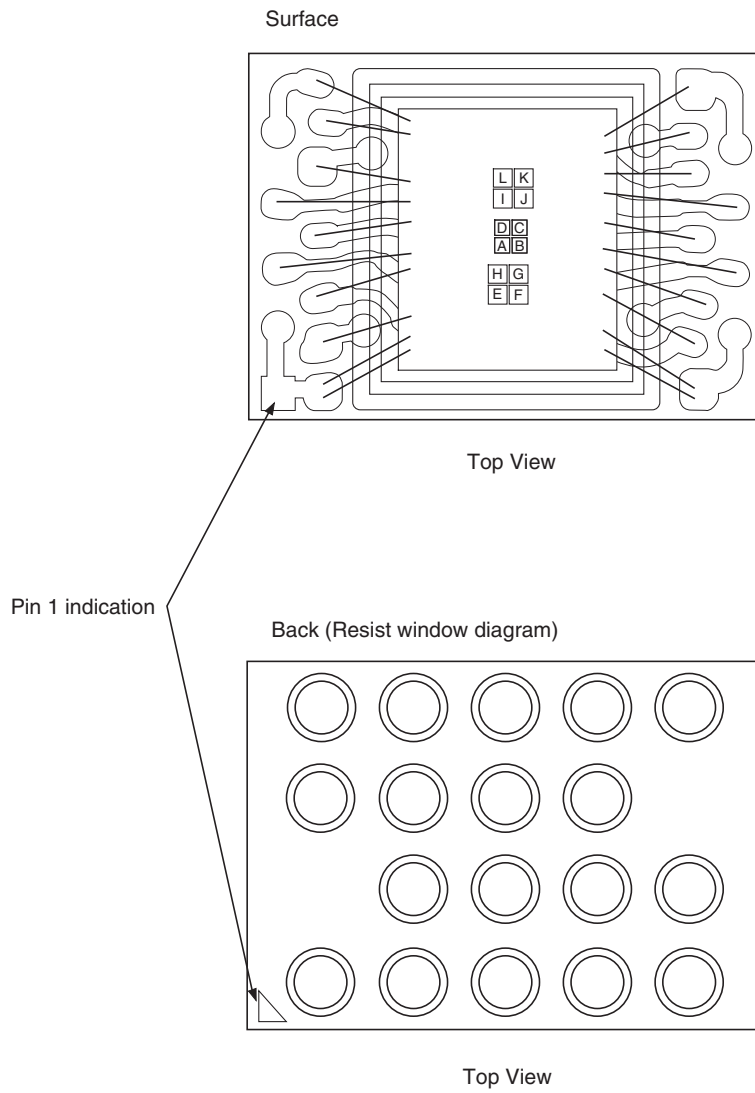

**Photodetector Position**

(Unit: mm)

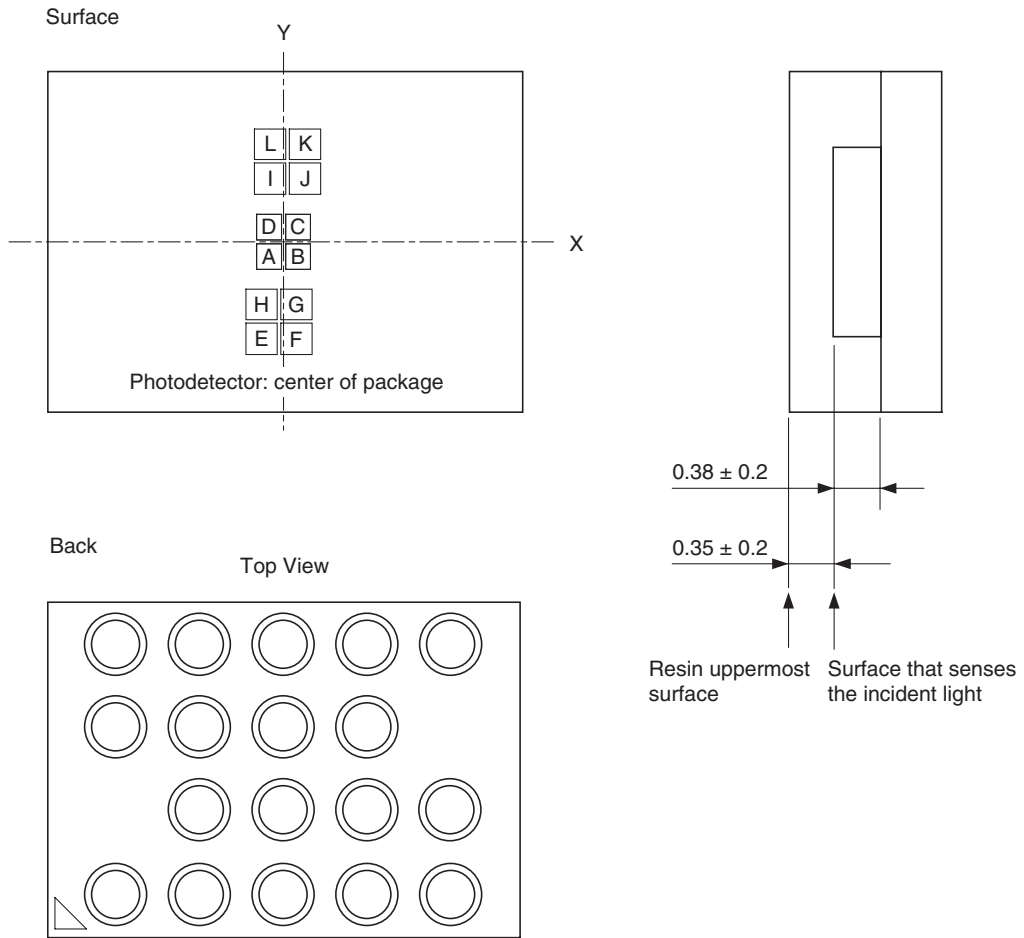

- ◆ The resin thickness (mechanical dimension) over the photodetector is  $0.35 \pm 0.2$ mm.  
The resin refractive index is as follows.  
650nm:  $n = 1.55$ , 780nm:  $n = 1.54$
- ◆ The photodetector center position accuracy is as follows.  
X, Y:  $0 \pm 0.16$ mm, angular  $\theta$ :  $0 \pm 2^\circ$  (with the X axis as  $\theta = 0^\circ$ )

Package Outline

(Unit: mm)

18PIN LFLGA

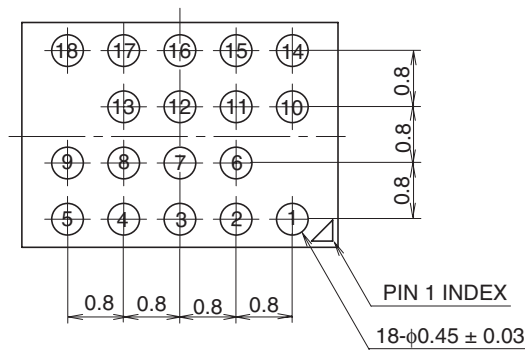
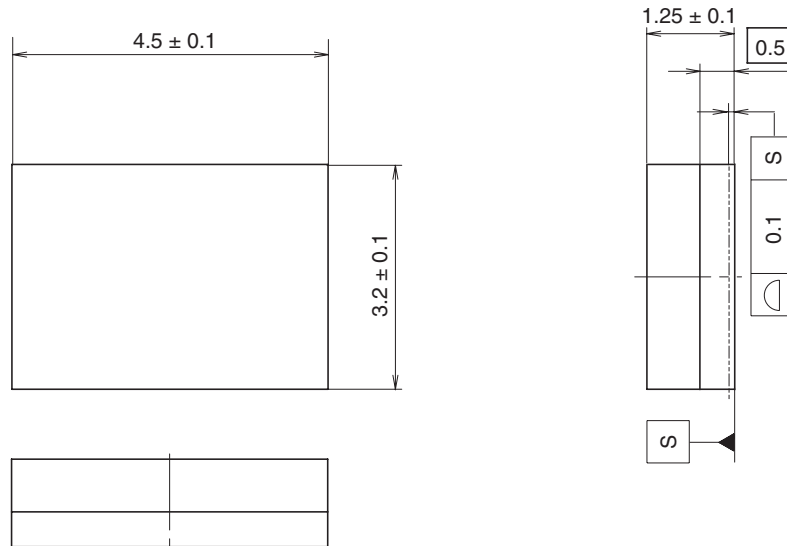

SONY CODE	LFLGA-18P-391
JEITA CODE	—
JEDEC CODE	—

PACKAGE MATERIAL	GLASS EPOXY
TERMINAL TREATMENT	NICKEL & GOLD PLATING
TERMINAL MATERIAL	COPPER
PACKAGE MASS	0.03g