



PCS/CDMA/AMPS Dual-Band Tri-Mode Power Amplifier Module

QCPM-9804

Features

- **Operating frequency:**
 PCS: 1850 - 1910 MHz
 AMPS: 824 - 849 MHz
 CDMA: 824 - 829 MHz
- **Typical Output Power @ 3.4V:**
 PCS : 28.5 dBm
 AMPS: 32.5 dBm
 CDMA: 28.5 dBm
- **Internal 50 ohm matching networks for both RF IN/OUT**
- **3.4 - 4.2 V operation** (reduced performance at 3V)
- **Dynamic bias controls** optimize PAE at low output power for PCS and cellular CDMA mode
- **11.5 mm x 11.5 mm SMT RF MultiPak**

Package Pin Configuration

(Back side)

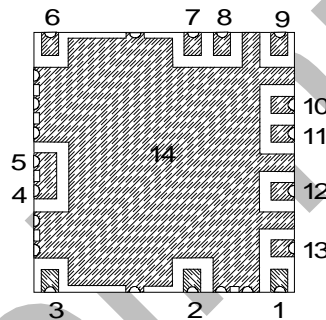

General Description

The Dual-Band Tri-Mode Power Amplifier Module (PAM) offers a highly integrated solution for CDMA dual-band tri-mode handsets. The integrated solution leads to improvements in cost, size, performance, and reliability. This PAM also offers several features that will make handset design more flexible and robust. The module contains two power amplifiers (PCS and Cellular PAs), two driver amplifiers with power control and bias circuits.

Applications

- Dual Band CDMA handsets
- Wireless Data terminals
- WLL
- Driver for Base station

Small SMT Multipak

The cellular power amplifiers provide: 32.5 dBm Pout and 47% Power Added Efficiency (PAE) at 3.4 V in AMPS mode, and 28.5 dBm Pout and 29% PAE at 3.4 V in cellular CDMA mode. While the PCS power amplifier achieves 28.5 dBm Pout and 28 % PAE at 3.4V in PCS mode. The PAM is designed with dynamic bias control to optimize the PAE at low output power in PCS and cellular CDMA mode to maximize the system talk time.

The surface mount RF MultiPak insures cost, size, and high volume manufacturing advantages over other traditional approaches.

Functional Block Diagram

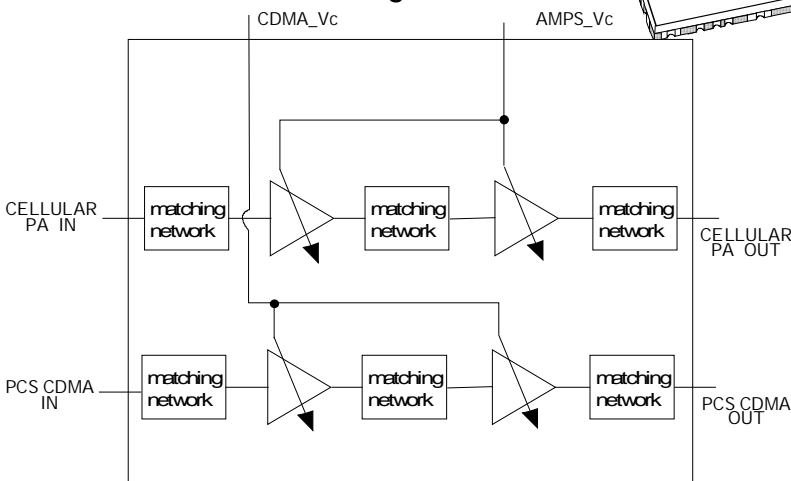

QCPM-9804 Absolute Maximum Ratings¹

Parameter	Cellular		PCS	
	Min.	Max.	Min.	Max.
V _{cc} supply voltage		4.5 V		4.5 V
Power Dissipation ^{2,3}		2.5 W		2.5 W
Bias Current		1.5 A		1.5 A
Amplifier Input RF Power		10 dBm		10 dBm
Junction temperature		+150 °C		+150 °C
Storage temperature (case temperature)	-40 °C	+120 °C	-40 °C	+120 °C

Thermal Resistance² $\theta_{jC} = X \text{ }^\circ\text{C/W}$

Notes:

1. Operation of this device in excess of any of these limits may cause permanent damage.
2. T_{case} = 25 °C
3. Derate at X mW/°C for T_{case} > 85 °C

Recommended operating range of V_{cc} = 3.4 to 4.2 V, T_a = -30 to +85 °C (reduced performance at 3.0 V and 110 °C)

QCPM-9804 Standard Test Conditions

All test are done in 50Ω system at 25 °C , unless noted otherwise.

V_{CC} = 3.4V

$$ACPR = \frac{\text{Channel Power in the 1.2288MHz band}}{\text{Power in a 30KHz band @}\pm 1.25\text{MHz away from the center of the channel}}$$

QCPM-9804 Summary Characterization Information

Parameter	Units	Min	Typ	Max	Comments
PCS Mode					
Frequency Range	MHz	1850		1910	
Gain (P _{out} = 28.5 dBm)	dB	22	24		V _C =2.5V
Gain (P _{out} = 16 dBm)	dB	19	21		V _C =1.8V
Output Power	dBm	28	28.5		
Power Added Efficiency					
P _{out} = 28.5 dBm	%	TBA	28		
P _{out} = 16 dBm	%	TBA	6		
Input VSWR (P _{out} = 28.5 dBm)			2.0:1		
Input VSWR (P _{out} = 16 dBm)			2.5:1		
Power Down Current	μA		40		
ACPR @ ± 1.25 MHz offset	dBc/30kHz	-45	-46		
ACPR @ ± 2.25 MHz offset	dBc/30kHz	-58			
Noise Power @ 80 MHz offset in 1930-1990 MHz)	dBm/Hz		-139		

QCPM-9804 Rev. G Feb-8-2000 Preliminary
Specification is subject to change without prior notification

Stability (Spurious): Load VSWR 5:1	dBc		55		All phases
Harmonics: 2Fo, 3Fo	dBc		-30		
CDMA mode					
Frequency Range	MHz	824		849	
Gain (P _{out} = 28.5 dBm)	dB	27	29		V _c =2.15V
Gain (P _{out} = 16 dBm)	dB	23	25		V _c =1.8V
Output Power	dBm		28.5		
Power Added Efficiency					
P _{out} = 28.5 dBm	%	TBA	29		
P _{out} = 16 dBm	%	TBA	6		
Input VSWR (P _{out} = 28.5 dBm)			2.0:1		
Input VSWR (P _{out} = 16 dBm)			2.5:1		
Power Down Current	μA		40		
ACPR @ ± 0.885 MHz offset	dBc/30kHz	-45	-47		
ACPR @ ± 1.98 MHz offset	dBc/30kHz	-57			
Noise Power @ 45 MHz offset in 869 - 894 MHz	dBm/Hz		-140		
Stability (Spurious): Load VSWR 4:1	dBc		55		All phases
Harmonics: 2Fo, 3Fo	dBc		-30		
AMPS mode					
Frequency Range	MHz	824		849	
Output Power (P _{in} = 7.5 dBm)	dBm		32.5		
Power Added Efficiency (P _{out} = 32.5 dBm)	%	TBA	47		V _c =2.15V
Noise Power @ 45 MHz offset in RX band (869-894MHz)	dBm/Hz		-136		
Harmonics: 2Fo, 3Fo	dBc		-30		
Input VSWR			2:1		
Switching Time					
DC ON/OFF	μs		40		
RF ON/OFF	μs		6		

QCPM-9804 Pin Description Table

No.	Mnemonic	Description	Typical Signal	Notes
1	CDMA_IN_A	Input RF for PCS CDMA	RF input	
2		Not connect		
3	CDMA OUT	RF PCS CDMA output	RF Output	
4	CDMA Vcc	Supply voltage for CDMA	DC	
5	AMPS Vcc	Supply voltage for AMPS and cellular CDMA	DC	
6	AMPS OUT	RF AMPS and cellular CDMA output	RF Output	
7		Not connect		
8		Not connect		
9	AMPS IN	RF AMPS and cellular CDMA input	RF	
10	AMPS_Vc	Bias control for AMPS and cellular CDMA PA		
11	Vcc_IC	Supply voltage for control and driver	DC	
12		Not connect		
13	CDMA_Vc	Bias control for PCS CDMA PA		
14	GND	Ground plane (back of the module)		

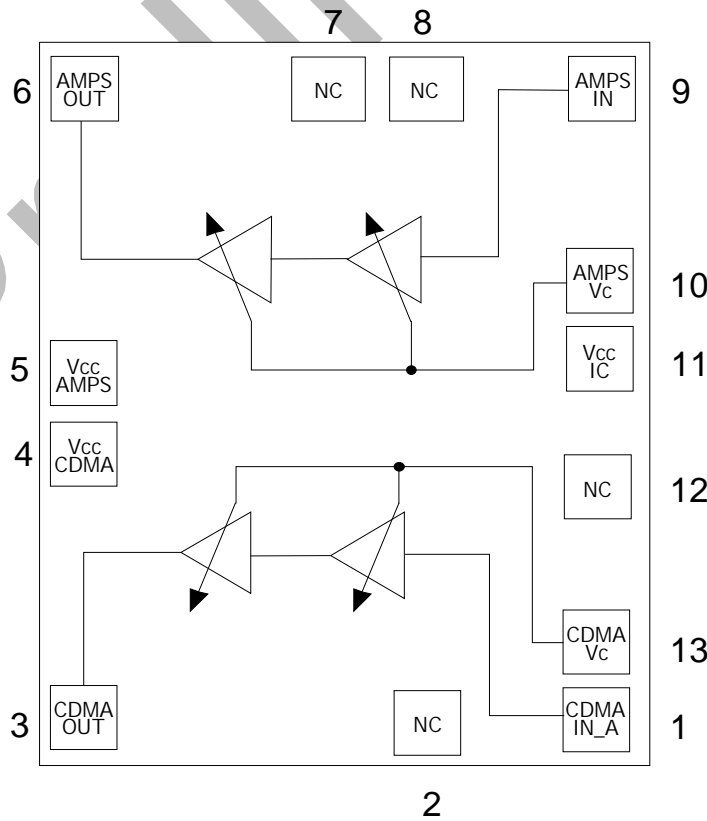

Figure 1 Internal block diagram with pinout (back side)

QCPM-9804 Rev. G Feb-8-2000 Preliminary
Specification is subject to change without prior notification

Part Number Ordering Information

Part Number	No. of Devices	Container
QCPM-9804		

Package Dimensions Small MultiPak-16 Package (in inches)

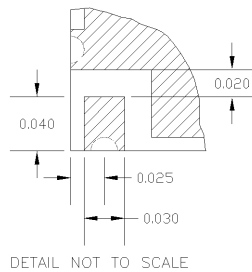
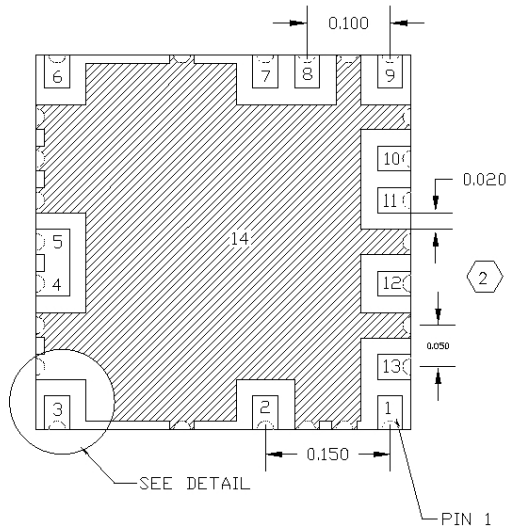
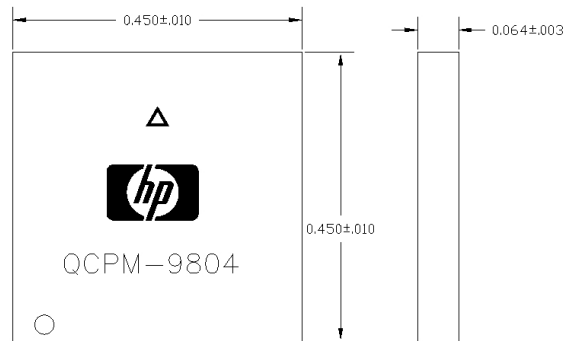

Land Pattern Recommendation:

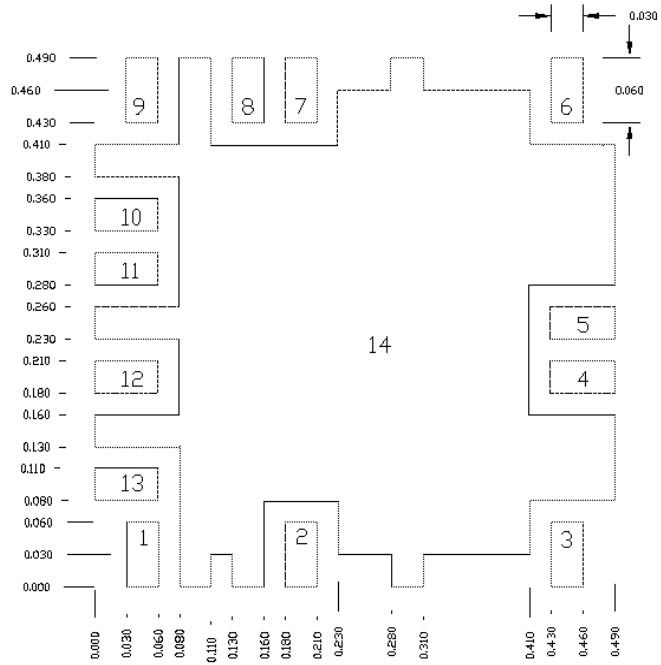

Notes:

1. All pads are 50 mil pitch with 20 mil spacing
2. Module to be centered on the land pattern
3. Pins 1, 3, 6, and 9 are 50 Ω
4. Pins 1 and 9 are DC shorts

for more information:
United States: call your local HP sales office
listed in your telephone directory.
Ask for a components representative.

Canada: (416) 206-4725

Europe: (44) 276-685783

Asia Pacific / Australia: (65) 290-6360

Japan: (81) 3 3331-6111
Data subject to change

Copyright © December 1998 Hewlett packard Co.
Printed in U.S.A.