

# SIEMENS

## SFH 900 — A Low-Cost Miniature Reflex Optical Sensor Appnote 26

Whether for an industrial plant or a hobbyists' drilling machine, an electric drive will hardly be acceptable nowadays without speed control. Incremental bar patterns simply applied to rotating shafts can be detected by the new Siemens reflex optical sensor, the SFH 900. The information can be processed with a minimum of circuitry, whether for a high rate of black-to-white transitions or just single, slow transitions.

### Construction

The SFH 900 optical sensor is a remarkable component even by virtue of its shape alone. Its maximum height of 2.2 mm is in the trend of today's electronics, of putting a large number of functions into a very small space. The small dimensions allow it to be used where ordinary optical sensors run into space or other problems. Fig. 1 is an enlarged picture of the device. Dimensions and pin configuration are shown in Fig. 2.

Fabricated by lead frame technique in a thermoplastic package, the sensor uses a GaAs infra-red diode as a radiation emitter and a large-area phototransistor as the detector. High sensitivity is ensured by a 1 mm<sup>2</sup> radiation sensitive area and a current gain of almost 1000. The effect of unwanted ambient light is almost screened out by a filter.

Two fixing notches are a help in mounting the device. Lead frame technology accurately locates the optically active areas relative to these notches and thus to the component body. Fig. 3 is an example of one form of mounting.

Fig. 1 SFH 900 reflex optical sensor, front and back view, shown here three times normal size

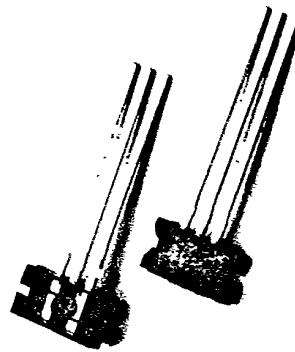
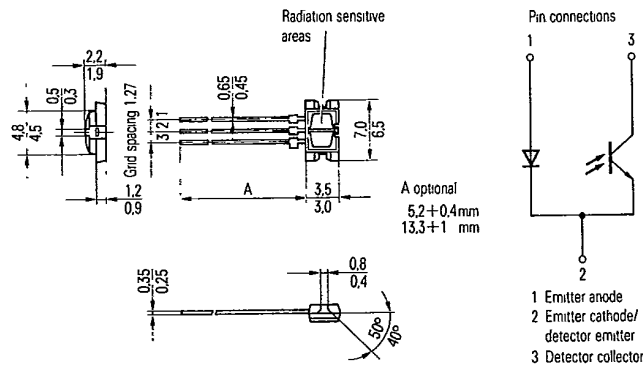

Fig. 2 Outline dimensions and pin connections of SFH 900



**Characteristics**

Main technical data are given in the Table. Turn-on and turn-off times are also important. These depend essentially on the collector current  $I_C$  and the load resistance  $R_L$ . Typical switching times for  $I_C = 1$  mA and  $R_L = 1$  k $\Omega$  are 50 to 70  $\mu$ s.

The user will be mainly concerned with the following points:

- What collector current,  $I_C$ , can be expected under given static conditions?
- What are the signal amplitudes when scanning bar patterns of different pitches?
- What is the temperature dependence of the collector current and what is the repeatability of the measured values?

**Collector current**

Dependence of collector current on emitter diode forward current  $I_F$  is almost linear at forward currents above 10 mA, as can be seen from Fig. 4. At currents below 1 mA the dependency shows almost a square law. The measurement was made with a standard reflector (Kodak neutral white test card,  $r = 90\%$ ) at a distance of 1 mm. Fig. 5 shows  $I_C$  characteristics for distances of 0.2 to 10 mm at a constant forward current of 10 mA. The curves are for four different reflecting materials: two standard Kodak reflectors with 15% and 90% reflection, polished aluminium and a strongly absorbing foil. DC-fix adhesive tapes and other tapes commonly used for printed circuit layouts proved particularly suitable. It should be mentioned that the curve for polished aluminium in Fig. 5 is very similar to the Kodak reflector response with  $r = 90\%$ , in spite of the reflection being mirrored by the metal and diffused by the standard reflector, as a result of the wide directional characteristics of the emitter and detector.

At short distances (e. g.  $d = 0.25$  mm) very large changes of current per unit distance are obtained. Because of these steep edges, which can only be used dynamically, the SFH 900 may also be utilized as a microphone.

**Fig. 3** Suggestion for mounting the SFH 900. Projections N in the flexible plastic clamp locate in corresponding notches in the body of the optical sensor

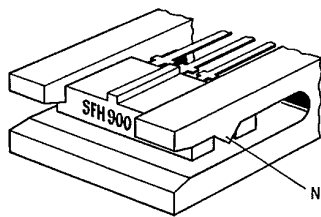

**Fig. 4** SFH 900 collector current  $I_C$  as a function of forward current  $I_F$  with 90% diffuse reflector at distance  $d = 1$  mm and with  $U_S = 5$  V

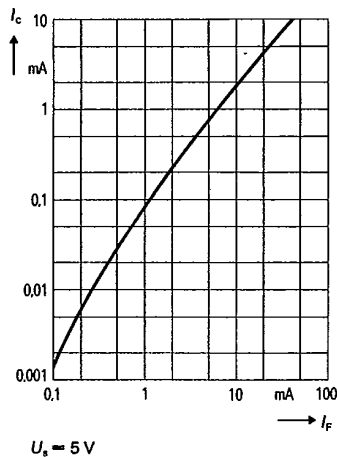

**Fig. 5** SFH 900 collector current  $I_C$  as a function of reflector distance  $d$  with different reflector materials

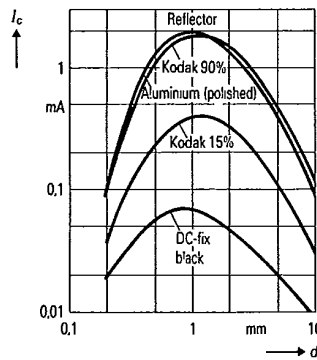
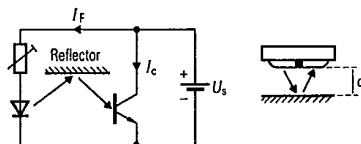

Forward current  $I_F = 10$  mA  
Operating voltage  $U_S = 5$  V.

**Emitter (GaAs infra-red diode)**

Reverse voltage  
Forward dc current  
Surge current ( $t \leq 10 \mu\text{s}$ )  
Power dissipation ( $T_{\text{amb}} = 40^\circ\text{C}$ )  
Thermal resistance

$U_R$	6	V
$I_F$	50	mA
$I_{FSM}$	1.5	A
$P_{tot}$	80	mW
$R_{thJU}$	750	K/W

**Detector (silicon phototransistor)**

Collector-emitter voltage  
Emitter-collector voltage  
Collector current  
Total power dissipation ( $T_{\text{amb}} = 40^\circ\text{C}$ )  
Collector-emitter leakage current ( $U_{CE} = 10\text{ V}$ )  
Photocurrent under ambient light ( $U_{CE} = 5\text{ V}$ )  
( $E_e = 0.5\text{ mW/cm}^2$ )

$U_{CEO}$	30	V
$U_{ECO}$	7	V
$I_C$	10	mA
$P_{tot}$	100	mW
$I_{CEO}$	20 ( $\leq 200$ )	nA
$I_F$	$\leq 3$	mA

**Reflex optical sensor**

Storage temperature range  
Ambient temperature range  
Junction temperature  
Total power dissipation ( $T_{\text{amb}} = 40^\circ\text{C}$ )  
Collector current  
( $I_F = 10\text{ mA}$ ;  $U_{CE} = 5\text{ V}$ ;  $d = 1\text{ mm}$ )

SFH 900-1	$T_S$	-40 to +85	$^\circ\text{C}$
SFH 900-2	$T_U$	-40 to +85	$^\circ\text{C}$
	$T_J$	100	$^\circ\text{C}$
	$P_{tot}$	150	mW
	$I_{CE}$	$\geq 0.3$	mA
	$I_{CE}$	$\geq 0.5$	mA

Table Selective characteristics of SFH 900

**Resolution of black-and-white patterns**

As can be seen from Fig. 5, strongly reflecting and badly reflecting materials give collector currents differing by a factor of about 25. Strongly reflecting means »white«, badly reflecting »black«.

If a black-to-white transition is scanned, the displacement distance between the »fully white« signal and the »fully black« signal is 4 to 5 mm (Fig. 6).

If, in contrast, a regular bar pattern is scanned, the signal amplitude becomes smaller the smaller the bar width. Fig. 7 shows clearly how the excursion is affected: the maximum white signal becomes smaller with decreasing bar width, while the minimum black signal becomes larger. Fig. 8 shows the signal excursion itself, to make it clearer. Here a regular pattern and a single white bar are compared. The excursion is referred to a single black-to-white transition corresponding to a 100% signal excursion.

A bar width of 3 mm can thus be detected without significant loss of sensitivity. The signal excursion, however, drops to as low as 10% using a grid of 1 mm bar

Fig. 7 Maximum and minimum collector current when scanning a black-white pattern

Fig. 6 Resolution of a black-to-white transition. Relative collector current as a function of sensor position  $s$ 

Fig. 8 Relative signal excursion as a function of white bar width

$I_F = 10\text{ mA}$ ,  $d = 1\text{ mm}$

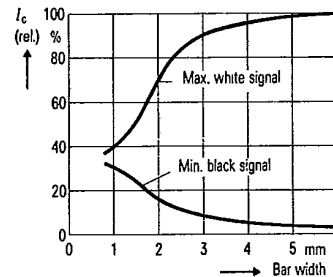
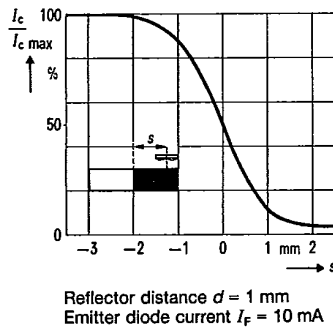
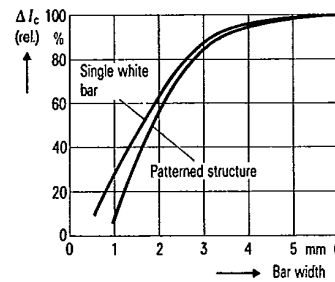

width. An apparently higher signal excursion is obtained when a single 1 mm wide white bar on a black background is scanned. The result is then about a 30%, as shown in Fig. 8.

The optical sensor can be used for scanning in any position, regardless of whether the emitter-detector axis is at right-angles to the scanning direction. Tests have shown that the device sensitivity is independent of direction. If a white spot on a black background (or vice-versa) is to be detected without loss of sensitivity, this should have a minimum area of 5x5 mm. From this we can conclude that a pattern bar must not be larger than 5 mm.

Thus the resolution capability of the SFH 900 seems to be limited to bar widths of 1 to 2 mm minimum. In fact, however, considerably higher resolutions can be obtained when gratings are used. An example is given below.

#### Temperature dependence

The temperature dependence of the output signal is shown in Fig. 9. This fortunately very small dependence results from the combination of the temperature dependent diode emission (approx.  $-0.55\%/K$ ) with the temperature dependent current gain of the phototransistor (approx.  $+0.9\%/K$ ). As these two parameters partly compensate for each other the temperature dependence of the output signal is fairly small.

There is a spread of characteristics in the different devices but they remain within the specified tolerance range, allowing for ageing, with a probability of at least 95%.

## Applications

### Speed control for dc motors

A simple speed regulator circuit for small dc motors can be designed using the TCA 955 device. Fig. 10 is an example. The teeth of a toothed wheel on the motor shaft serve as reflectors (40 teeth on a wheel of approx. 60 mm diameter). Pulses from the optical sensor are converted by the TCA 955 into a dc voltage proportional to speed. The pulse signal is first amplified, then frequency doubled, then fed to a monostable which produces a square wave with a constant pulse duration determined by the  $R_1 C_1$  product. The mean value of this pulse train is determined by capacitor C2 and an 8.7 k $\Omega$  internal resistor.

The voltage present at C2, still with a slight triangular modulation, is compared with an internal set value. The difference is amplified and determines the duty cycle in the subsequent mark-to-space ratio converter. The motor is connected to the operating voltage via a BD 675 switching stage, which runs to the rhythm of the duty cycle. A larger mark-to-space ratio causes the speed to increase. The desired frequency can be set by P1 over a wide range.

### Speed control for ac motors

This is mainly intended for use in the consumer field, in such things as kitchen appliances and drilling machines. It is important that the speed indicator should have a very low current consumption as it is supplied from a simple line rectifier circuit using a series resistor. The specimen circuit in Fig. 11 has an emitter diode current of only

Fig. 9 Relative collector current as a function of temperature

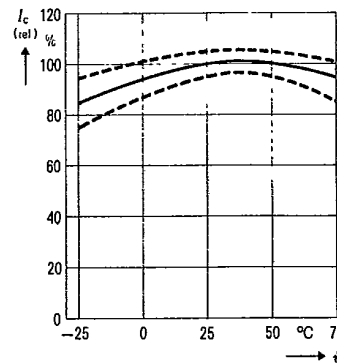

$U_s = 5 \text{ V}$                        $d = 1 \text{ mm}$   
 $I_E = 10 \text{ mA}$                        $r = 90\%$   
 — typical response  
 - - - spread of characteristics  
 (including long-term effects)

2 mA. Signal processing and triac triggering are done by the new TLB 3101 phase control IC. Total current needed for control is around 7 mA, including the SFH 900.

Pulses from the optical sensor are first amplified, then converted by a monostable to constant pulse width and finally filtered to give a mean value. By comparison with a sawtooth voltage the gate trigger time for the triac is fixed. A soft start is given by transistor T1.

The range of speed regulation is 5000 to 15000 rpm. The reflector is a disc mounted on the motor shaft, and at its periphery this disc has, as an example, 5 pairs of black and white segments.

### Shaft encoder with direction sensing

This example shows how gratings can be used to give a considerable increase in resolution. A transparent disc of about 130 mm diameter has an array of 200 opaque bars at its periphery (Fig. 12a). The bar width is thus about 1 mm. A second grating with reflecting white bars is placed under the disc. If the disc pattern and the grating beneath are set gap to gap, the detector »sees« 100% black. If the bars of the two gratings are on top of each other the image appears as 50% white. So, when the disc is rotating the useful amplitude is therefore about 50% of the full black-to-white excursion.

The grating pattern is constructed so that one half is displaced by 90° of a grid period with respect to the other half. If a reflex optical sensor is assigned to each half, on rotation of the disc the output signals will be roughly sinusoidal and displaced by 90° from each other. This means that patterns of half bar width can be successfully resolved.

In further processing both sinewave voltages are converted into square waveforms, also phase-shifted by 90° (Fig. 13).

Fig. 10 Speed regulator using SFH 900 reflex optical sensor and TCA 955 integrated speed control

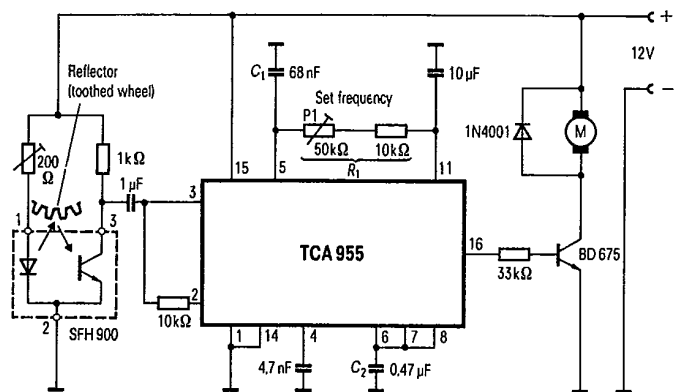
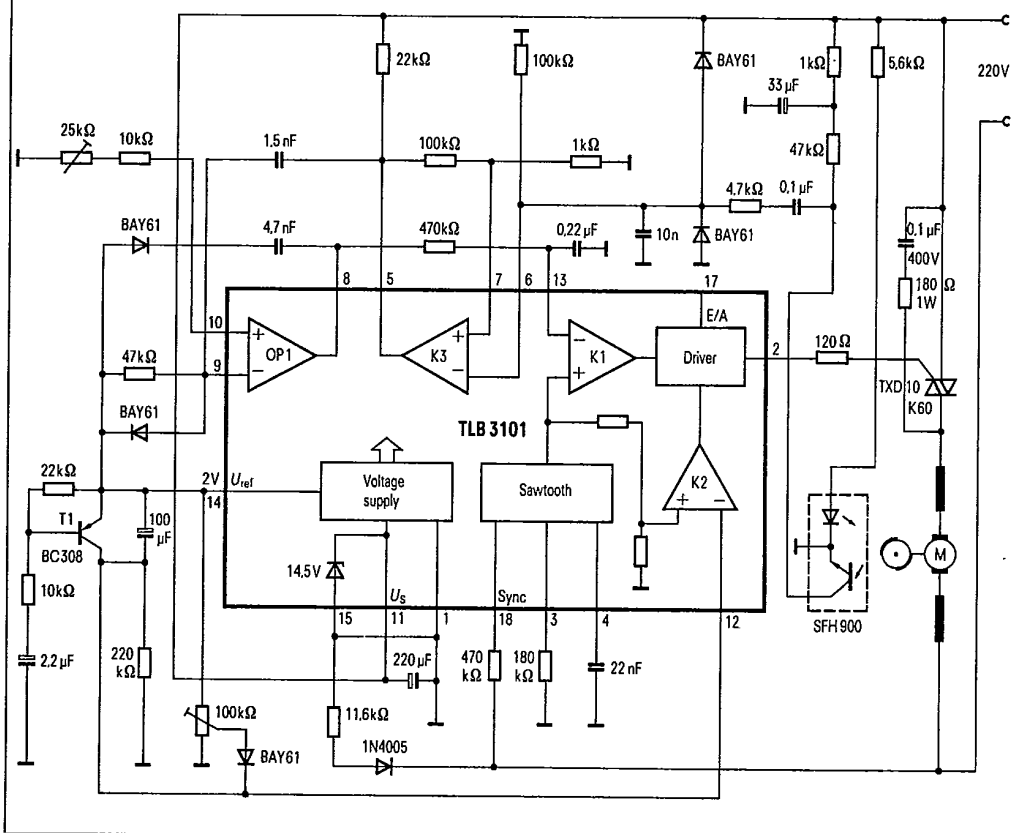

Fig. 11 Speed regulator for an ac motor using SFH 900 and TLB 3101



Application Notes

The rising edge of on square-wave (signal 1) is used for counting. It triggers a monoflop which generates a pulse of short duration relative to the square-wave period. The other, 90° shifted, square-wave controls the direction of the counter (Low = forward, High = backward).

According to the direction command, the conditions in Fig. 13 come into effect. The active clock edge coincides with either the low level or the high level of signal 2. Counting therefore takes place in accordance with forward or backward rotation of the shaft. Fig. 14 gives the detailed circuit diagram of the shaft encoder.

The counter used has a range of two decades and gives the BCD separately for each digit.

A 7-segment decoder-driver follows this for each of the two LED displays. The number of digits can be increased by cascading several stages.

For the purposes of explanation any bar in the pattern can be considered as the starting point and the counter reset to zero using the reset key. If now the disc is turned at any speed in either direction with respect to the stationary mark, the counter indicates the bar number difference with respect to the starting point. As only dc voltage coupling is used the rotational speed may have any arbitrary minimum value.

Fig. 12 Example of a patterned disc (a) and its counting grid (b)

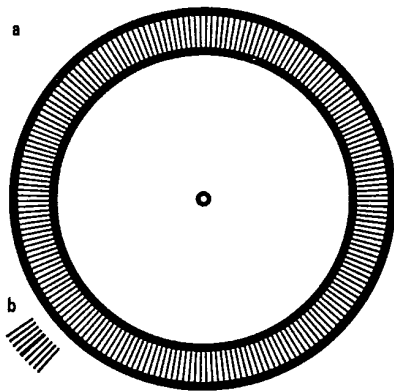

Fig. 13 Waveforms showing the operation of a shaft encoder with direction sensing

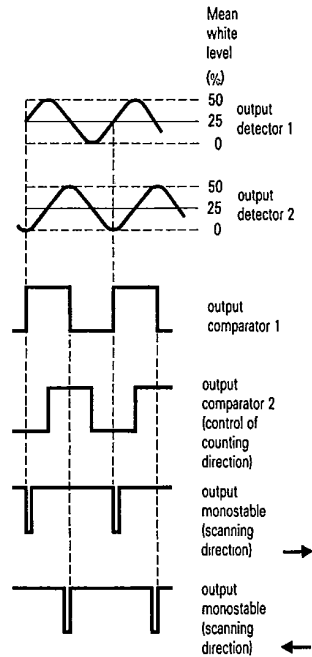

Fig. 14 SFH 900: circuit for shaft encoder with direction sensing

