

TriQuint Recommends the TGA4505-EPU be used for New Designs
24-31 GHz Ka Band HPA

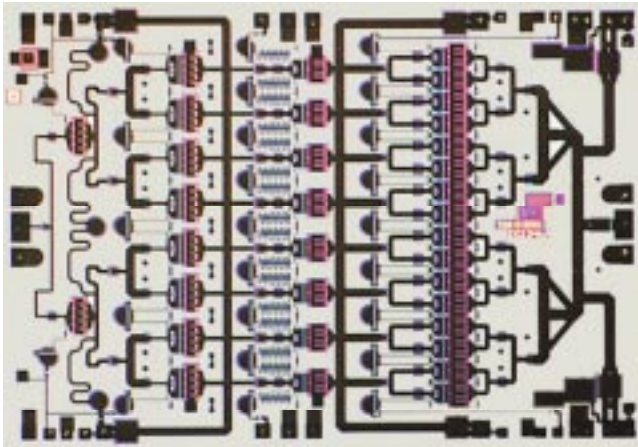

Chip Dimensions 4.3 mm x 3.0 mm x 0.05 mm

Key Features

- 0.25 um pHEMT Technology
- 23 dB Nominal Gain
- 34.5 dBm Nominal P1dB
- 40 dBm IMD3 Typical
- Bias 6 V @ 2.1 A

Primary Applications

- Satellite Ground Terminal
- Point-to-Point Radio

Product Description

The TriQuint TGA4501-SCC is a compact 3 Watt High Power Amplifier MMIC for Ka-band applications. The part is designed using TriQuint's proven standard 0.25 um gate Power pHEMT production process.

The TGA4501 provides a nominal 34.5 dBm of output power at 1 dB gain compression from 24-31 GHz with a small signal gain of 23 dB.

The part is ideally suited for low cost emerging markets such as base station transmitters for satellite ground terminals, point to point radio and LMDS.

The TGA4501-SCC is 100% DC and RF tested on-wafer to ensure performance compliance.

Fixture Data

Bias Conditions: $V_d = 6V, I_d = 2.1A \pm 5\%$

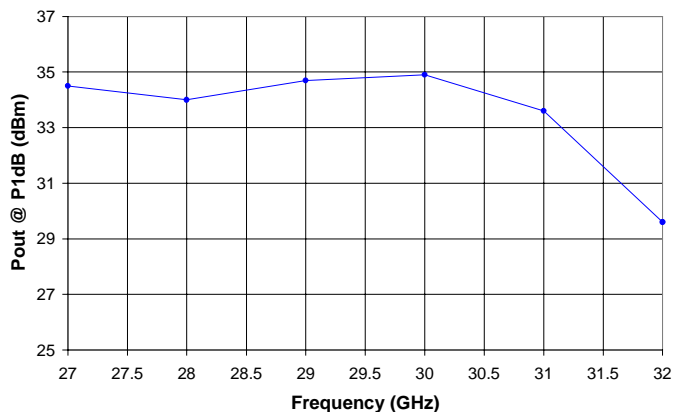
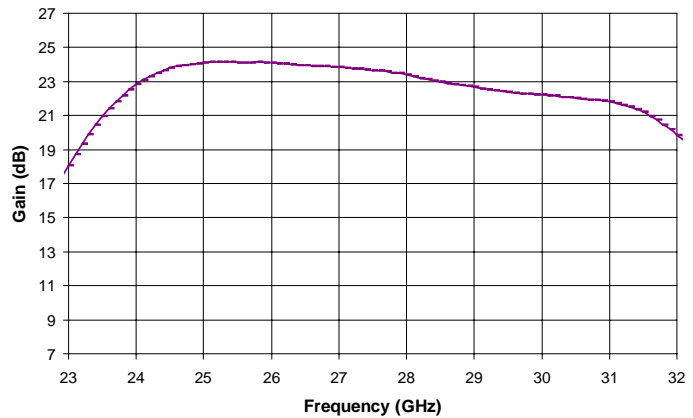

TriQuint Recommends the TGA4505-EPU be used for New Designs

**TABLE I
MAXIMUM RATINGS**

Symbol	Parameter <u>5/</u>	Value	Notes
V ⁺	Positive Supply Voltage	8 V	<u>4/</u>
V ⁻	Negative Supply Voltage Range	-5V TO 0V	
I ⁺	Positive Supply Current (Quiescent)	3.0 A	<u>4/</u>
I _G	Gate Supply Current	62 mA	
P _{IN}	Input Continuous Wave Power	24 dBm	
P _D	Power Dissipation	18.4 W	<u>3/ 4/</u>
T _{CH}	Operating Channel Temperature	150 °C	<u>1/ 2/</u>
T _M	Mounting Temperature (30 Seconds)	320 °C	
T _{STG}	Storage Temperature	-65 to 150 °C	

- 1/ These ratings apply to each individual FET.
- 2/ Junction operating temperature will directly affect the device median time to failure (T_M). For maximum life, it is recommended that junction temperatures be maintained at the lowest possible levels.
- 3/ When operated at this bias condition with a base plate temperature of 70 °C, the median life is reduced from 7.4 E+6 to 4.6 E+5 hours.
- 4/ Combinations of supply voltage, supply current, input power, and output power shall not exceed P_D.
- 5/ These ratings represent the maximum operable values for this device.

TriQuint Recommends the TGA4505-EPU be used for New Designs

TABLE II
DC PROBE TEST
(TA = 25 °C, nominal)

NOTES	SYMBOL	LIMITS		UNITS
		MIN	MAX	
<u>1/</u>	$I_{DSS(Q35)}$	15	70.5	mA
<u>1/</u>	$G_{M(Q35)}$	33	79.5	mS
<u>1/</u> , <u>2/</u>	$ V_{P(Q1, Q2, Q35)} $	0.5	1.5	V
<u>1/</u> , <u>2/</u>	$ V_{BVG S(Q35)} $	8	30	V
<u>1/</u> , <u>2/</u>	$ V_{BVG D(Q35)} $	11	30	V

1/ Q35 is a 150 um Test FET
2/ V_P , $V_{BVG D}$, and $V_{BVG S}$ are negative.

TABLE III
RF CHARACTERIZATION TABLE
 (T_A = 25°C, nominal)
 (V_d = 6V, I_d = 2.1A ±5%)

SYMBOL	PARAMETER	TEST CONDITION	LIMITS			UNITS
			MIN	TYP	MAX	
Gain	Small Signal Gain	F = 24-31 GHz	18	23		dB
IRL	Input Return Loss	F = 24-31 GHz	---	-6	----	dB
ORL	Output Return Loss	F = 24-31 GHz	---	-12	---	dB
PWR	Output Power @ P1dB	F = 27-31 GHz	34	35	---	dBm
IMR3	IMR3 @ SCL = P1dB - 10dB	F = 30 GHz	---	29	---	dBc
IMD3	Output IMD3	F = 30 GHz Pin = 0 dBm	---	40	---	dBc

Note: Table III Lists the RF Characteristics of typical devices as determined by fixtured measurements.

TABLE IV
THERMAL INFORMATION*

Parameter	Test Conditions	T _{CH} (°C)	R _{θJC} (°C/W)	T _M (HRS)
R _{θJC} Thermal Resistance (channel to backside of carrier)	V _d = 6V I _D = 2.048 A P _{diss} = 12.288 W	127.65	4.69	7.4E+6

Note: Assumes eutectic attach using 1.5 mil 80/20 AuSn mounted to a 20 mil CuMo Carrier at 70°C baseplate temperature. Worst case condition with no RF applied, 100% of DC power is dissipated.

* This information is a result of a thermal model analysis.

TriQuint Recommends the TGA4505-EPU be used for New Designs

Fixture Data

Bias Conditions: $V_d = 6\text{ V}$, $I_d = 2.1\text{ A} \pm 5\%$

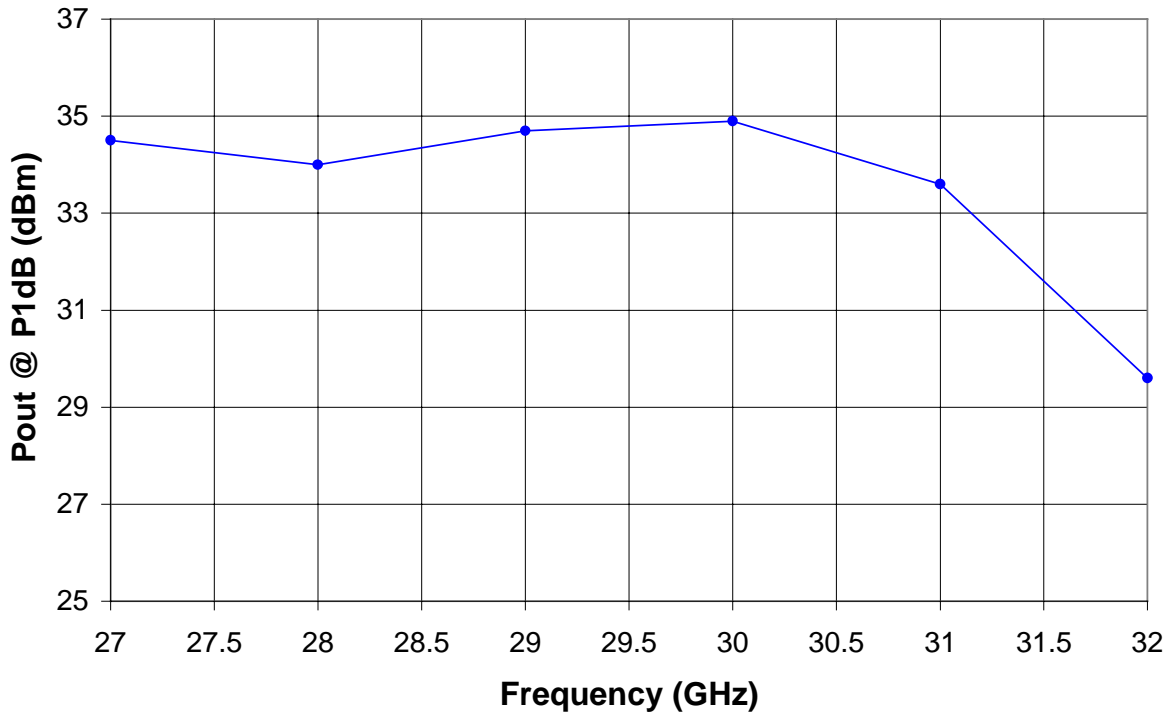
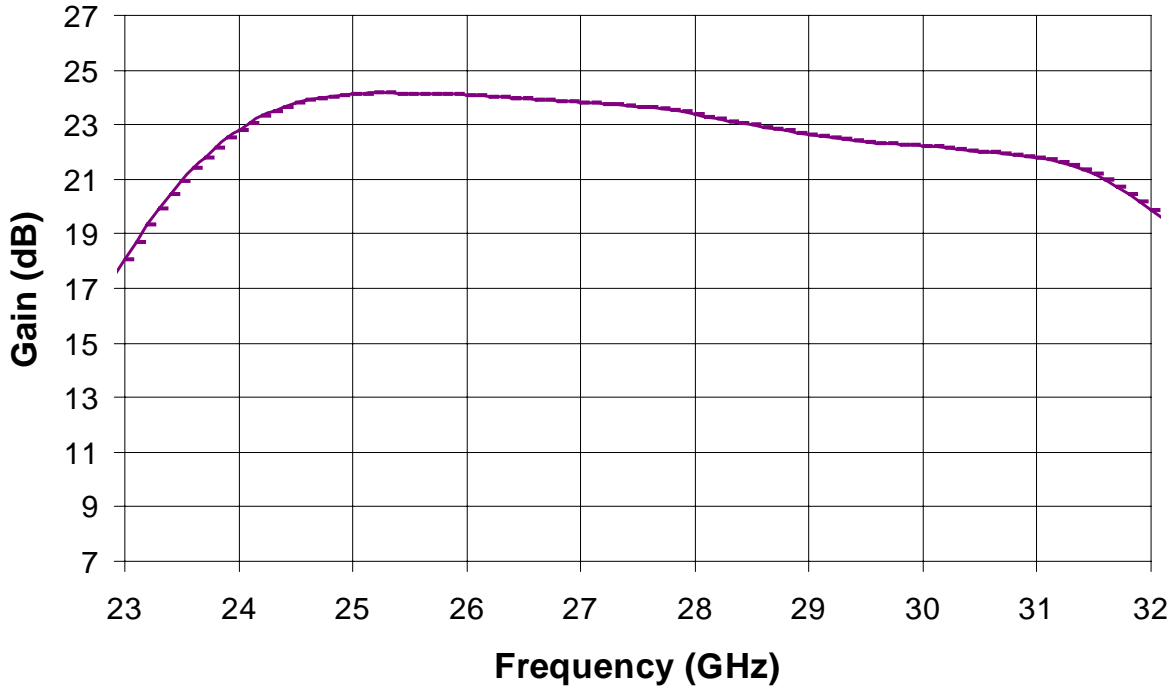

TriQuint Recommends the TGA4505-EPU be used for New Designs

Fixture Data

Bias Conditions: $V_d = 6\text{ V}$, $I_d = 2.1\text{ A} \pm 5\%$

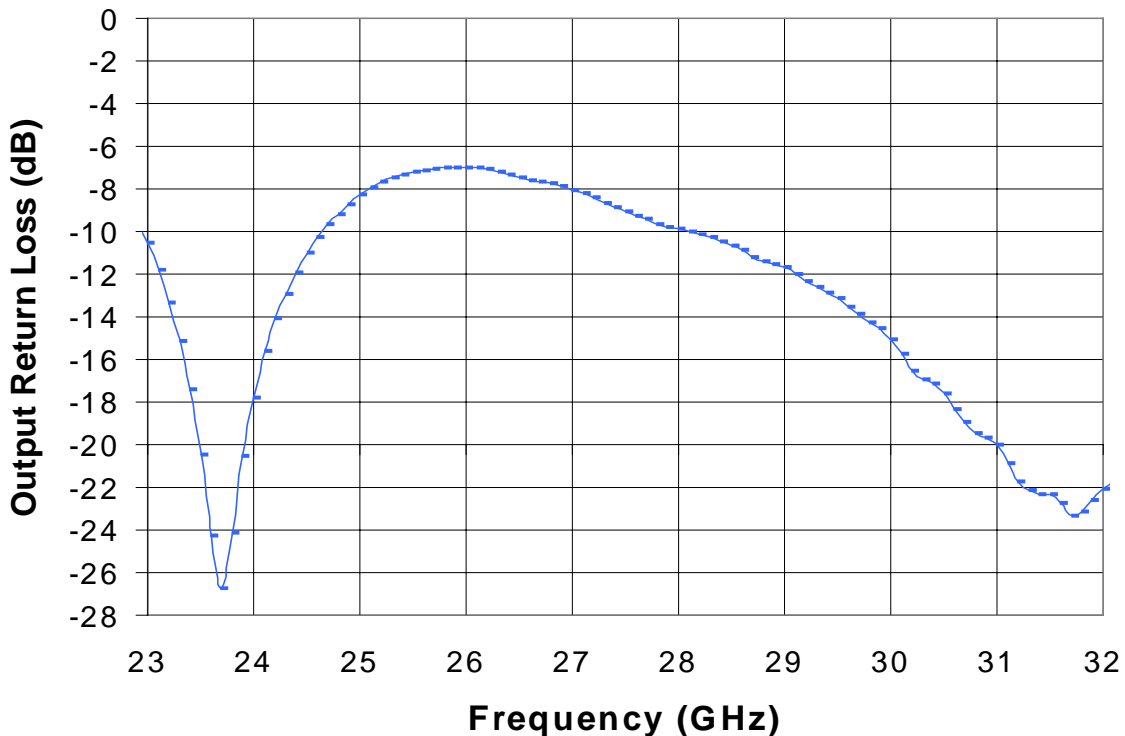
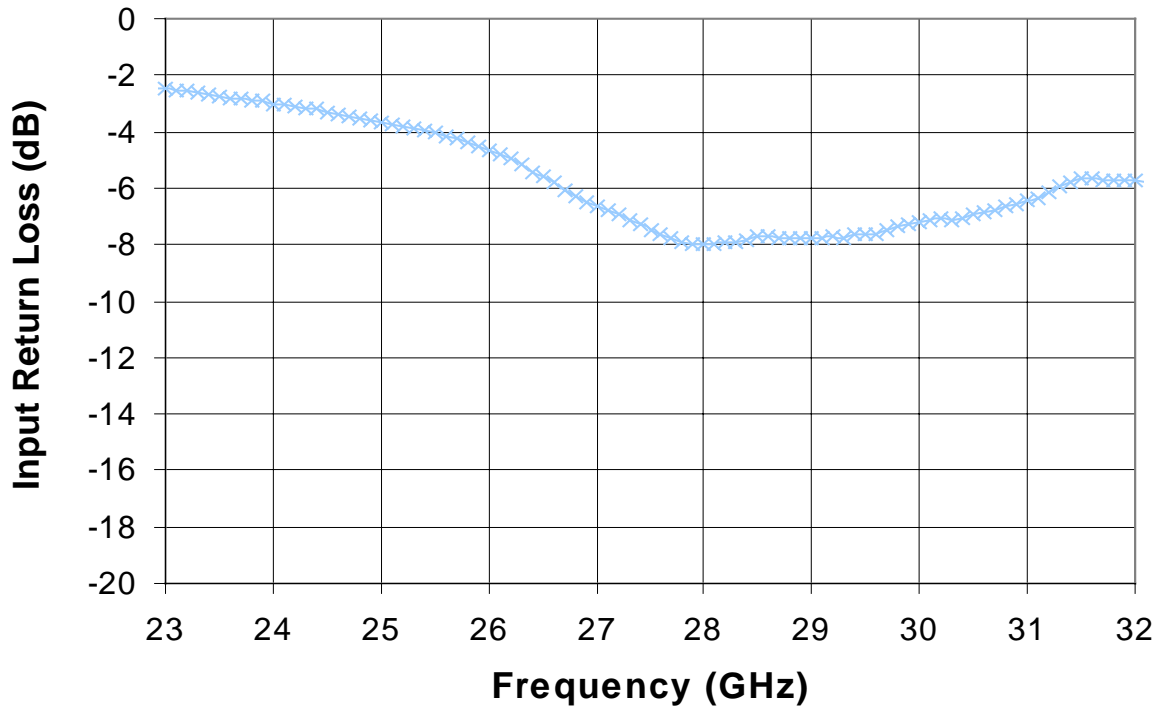

Fixtured Data

Bias Conditions: $V_d = 6\text{ V}$, $I_d = 2.1\text{ A} \pm 5\%$

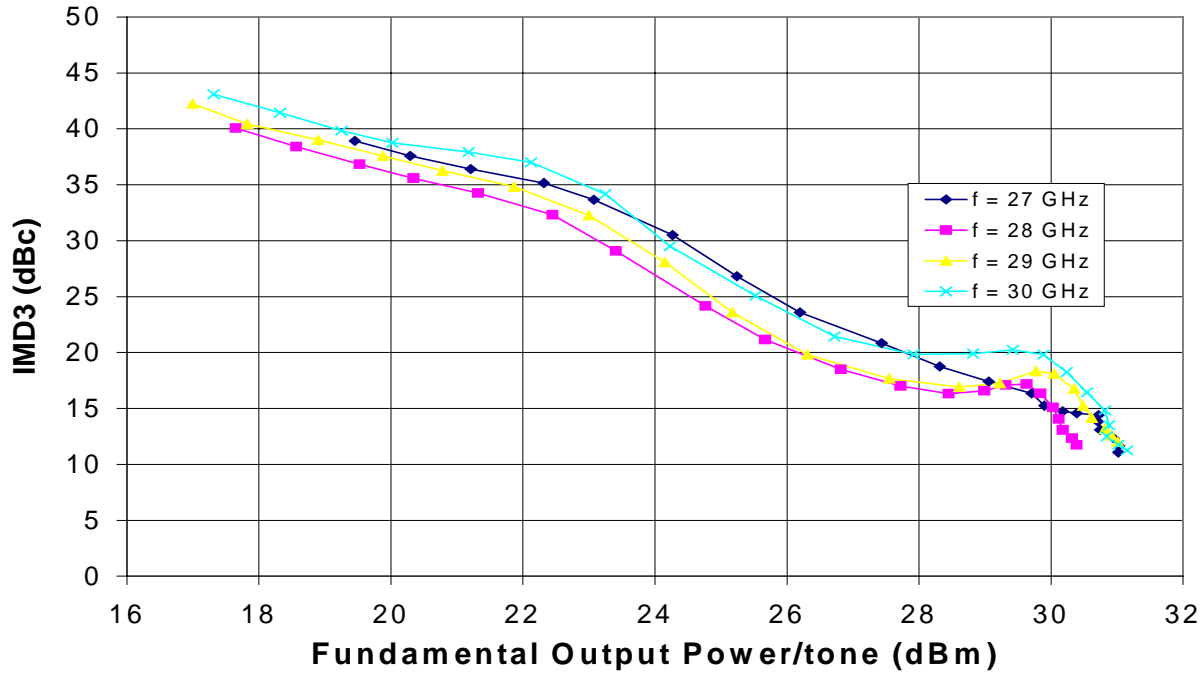

Fixtured Data taken @ 30 GHz

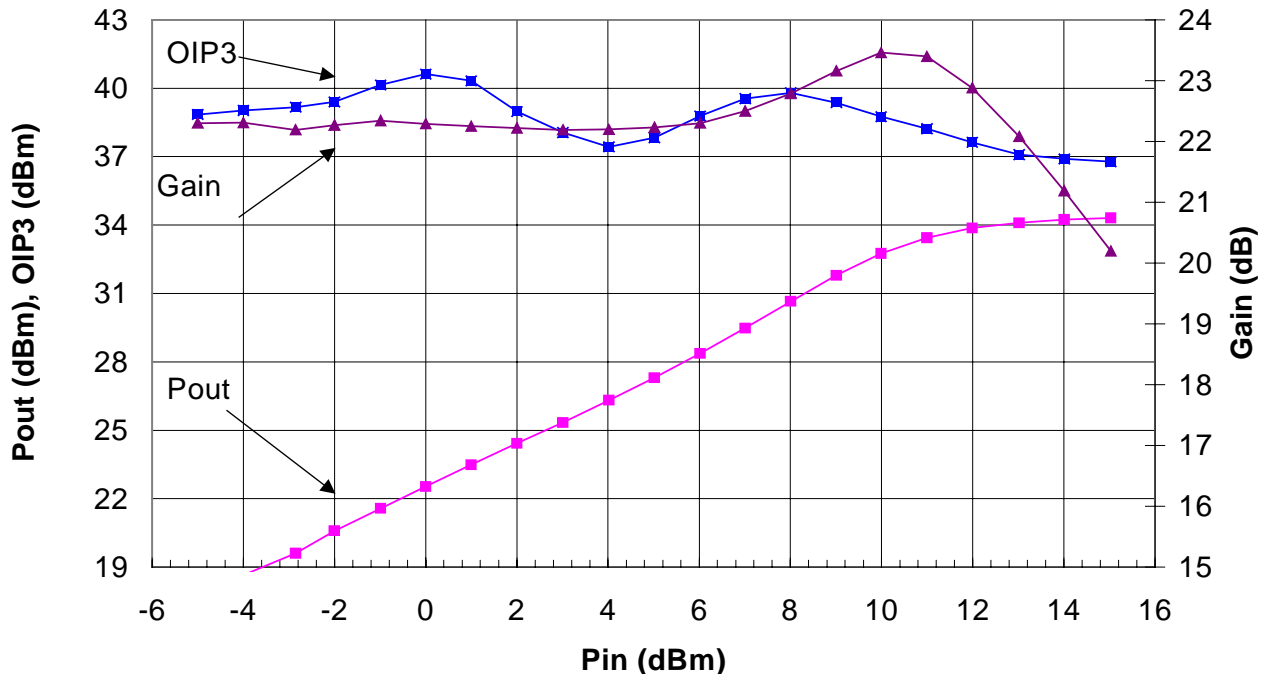

TriQuint Recommends the TGA4505-EPU be used for New Designs

**Recommended Chip Assembly & Bonding Diagram
Both-Sided Biasing Option**

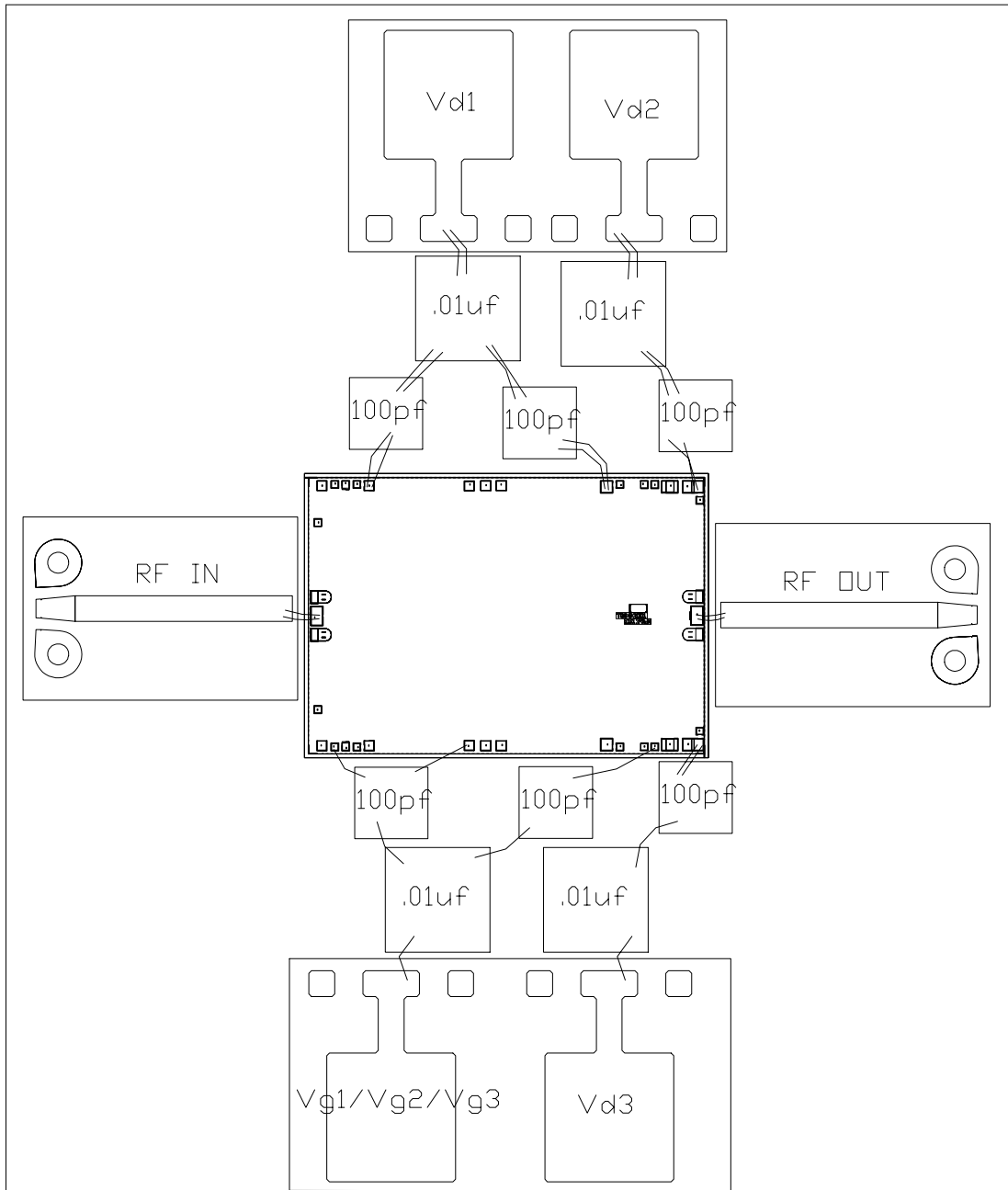

GaAs MMIC devices are susceptible to damage from Electrostatic Discharge. Proper precautions should be observed during handling, assembly and test.

TriQuint Recommends the TGA4505-EPU be used for New Designs

Alternative Chip Assembly & Bonding Diagram
Single-Side Biasing Option

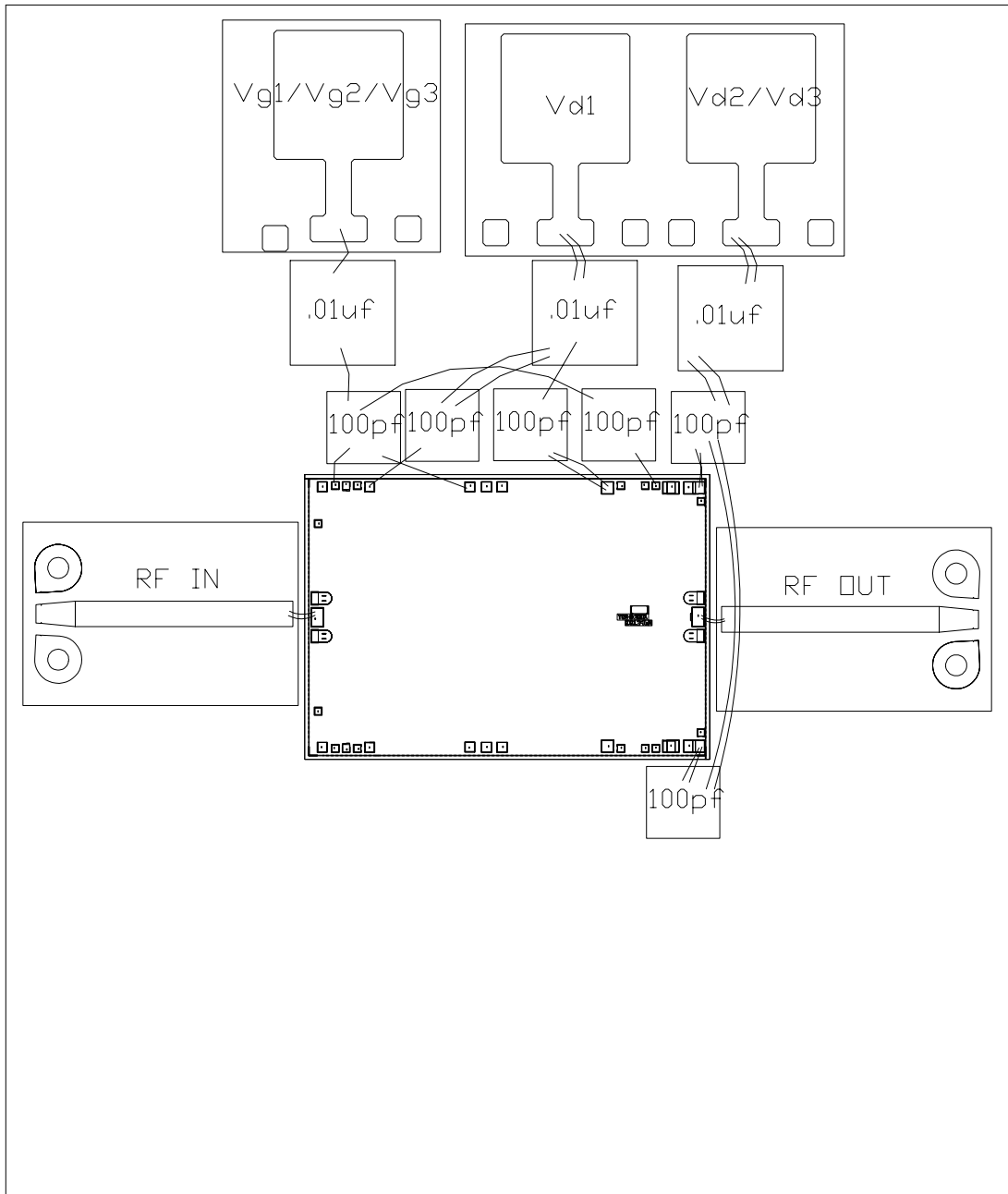

GaAs MMIC devices are susceptible to damage from Electrostatic Discharge. Proper precautions should be observed during handling, assembly and test.

TriQuint Recommends the TGA4505-EPU be used for New Designs
Mechanical Drawing

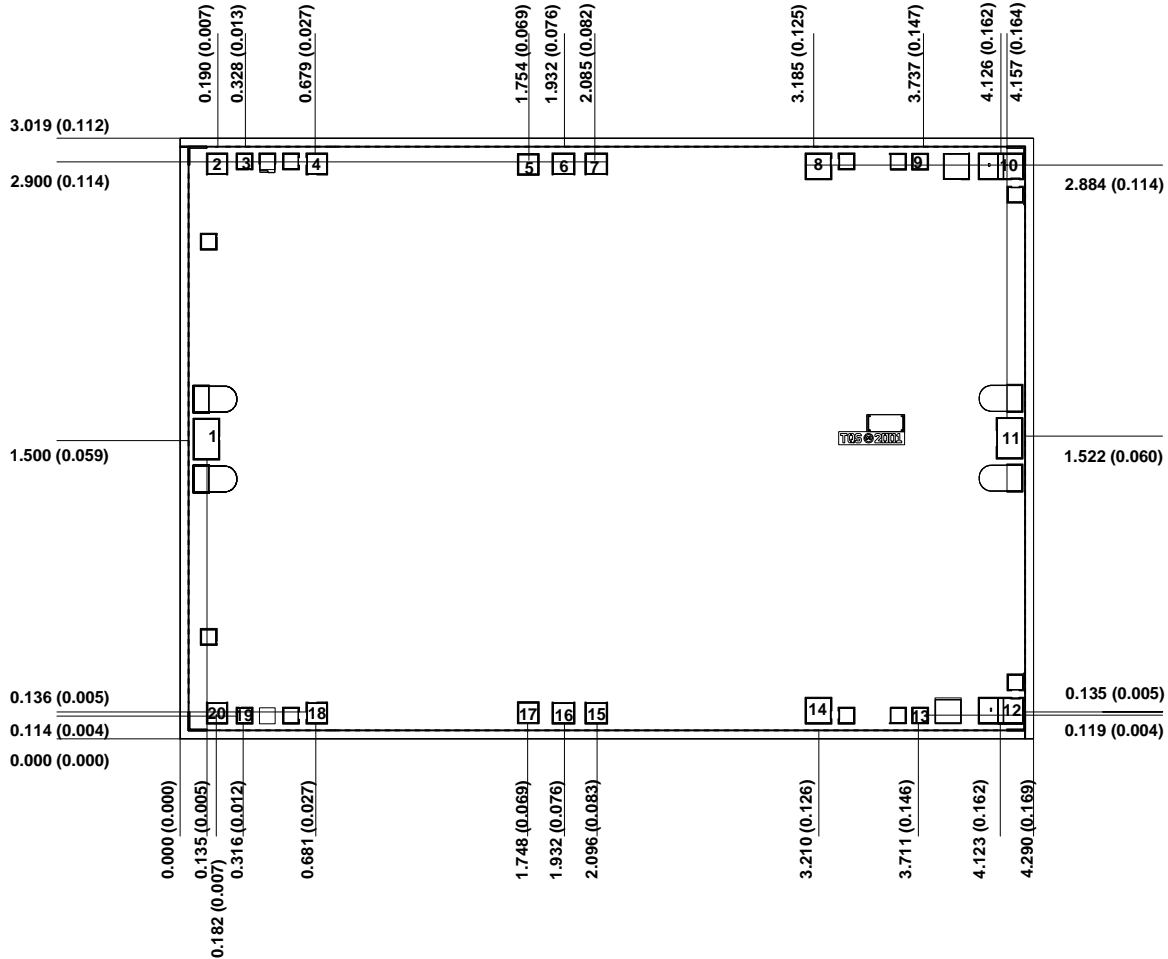

Units: Millimeters (inches)
Thickness: 0.05 (0.002) (reference only)
Chip edge to bond pad dimensions are shown to center of bond pad
Chip size +/- 0.05 (0.002)

GND IS BACKSIDE OF MMIC

Bond pad #1	(RF Input)	0.130 x 0.205 (0.005 x 0.008)
Bond pad #11	(RF Output)	0.130 x 0.205 (0.005 x 0.008)
Bond pad #2, 20	(DC GND)	0.102 x 0.105 (0.004 x 0.004)
Bond pad #3, 19	(VG1)	0.085 x 0.085 (0.003 x 0.003)
Bond pad #4, 18	(VD1)	0.105 x 0.105 (0.004 x 0.004)
Bond pad #5, 17	(VG2)	0.110 x 0.110 (0.004 x 0.004)
Bond pad #6, 7, 15, 16	(DC GND)	0.110 x 0.105 (0.004 x 0.004)
Bond pad #8, 14	(VD2)	0.130 x 0.130 (0.005 x 0.005)
Bond pad #9, 13	(VG3)	0.085 x 0.085 (0.003 x 0.003)
Bond pad #10, 12	(VD3)	0.230 x 0.130 (0.009 x 0.005)

GaAs MMIC devices are susceptible to damage from Electrostatic Discharge. Proper precautions should be observed during handling, assembly and test.

TriQuint Recommends the TGA4505-EPU be used for New Designs

Assembly Process Notes

Reflow process assembly notes:

- Use AuSn (80/20) solder with limited exposure to temperatures at or above 300°C (for 30 sec max).
- An alloy station or conveyor furnace with reducing atmosphere should be used.
- No fluxes should be utilized.
- Coefficient of thermal expansion matching is critical for long-term reliability.
- Devices must be stored in a dry nitrogen atmosphere.

Component placement and adhesive attachment assembly notes:

- Vacuum pencils and/or vacuum collets are the preferred method of pick up.
- Air bridges must be avoided during placement.
- The force impact is critical during auto placement.
- Organic attachment can be used in low-power applications.
- Curing should be done in a convection oven; proper exhaust is a safety concern.
- Microwave or radiant curing should not be used because of differential heating.
- Coefficient of thermal expansion matching is critical.

Interconnect process assembly notes:

- Thermosonic ball bonding is the preferred interconnect technique.
- Force, time, and ultrasonics are critical parameters.
- Aluminum wire should not be used.
- Discrete FET devices with small pad sizes should be bonded with 0.0007-inch wire.
- Maximum stage temperature is 200°C.

GaAs MMIC devices are susceptible to damage from Electrostatic Discharge. Proper precautions should be observed during handling, assembly and test.