

M5228P/FP

QUAD LOW-NOISE OPERATIONAL AMPLIFIERS (DUAL POWER SUPPLY TYPE)

DESCRIPTION

The M5228 is a semiconductor integrated circuit designed for a low-noise preamplifier in audio equipment and a general-purpose operational amplifier in other electronic equipment. Four low-noise operational amplifier circuits displaying internal phase-compensated high gain and low distortion are contained in a 14-pin standard DIP and 14-pin mini flat (FP) package for application over a wide range as a general-purpose dual amplifier in general electronic equipment.

The device has virtually the same characteristics as the 4557, 4558, 4559 and 741 operational amplifiers. The unit can also be used as a single power supply type and amplifier in portable equipment. It is also suitable as a headphone amplifier because of its high load current.

FEATURES

- High gain, low distortion
 $G_{VO} = 110\text{dB}$, $\text{THD} = 0.0015\%$ (typ.)
- High slew rate, high f_T $\text{SR} = 2.2\text{V}/\mu\text{s}$, $f_T = 7\text{MHz}$ (typ.)
- Low noise ($R_G = 1\text{k}\Omega$) FLAT $V_{NI} = 2\mu\text{Vrms}$ (typ.)
 RIAA $V_{NI} = 1\mu\text{Vrms}$ (typ.)
- Operation with low supply voltage $V_{CC} \geq 4\text{V} (\pm 2\text{V})$
- High load current, high power dissipation
 $I_{LP} = \pm 50\text{mA}$, $P_d = 700\text{mW}$ (M5228P)
 $P_d = 550\text{mW}$ (M5228FP)

APPLICATION

General-purpose amplifier in stereo equipment, tape decks and radio stereo cassette recorders; active filters, servo amplifiers, operational circuits in other general electronic equipment.

RECOMMENDED OPERATING CONDITION

- Supply voltage range $\pm 2 \sim \pm 16\text{V}$
- Rated supply voltage $\pm 15\text{V}$

PIN CONFIGURATION (TOP VIEW)

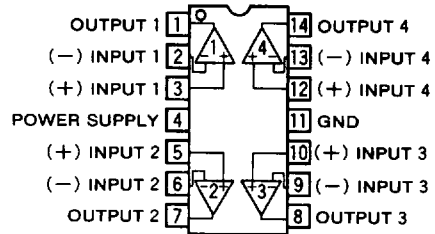

Outline 14P4 (P)
14P2S-A (FP)

BLOCK DIAGRAM

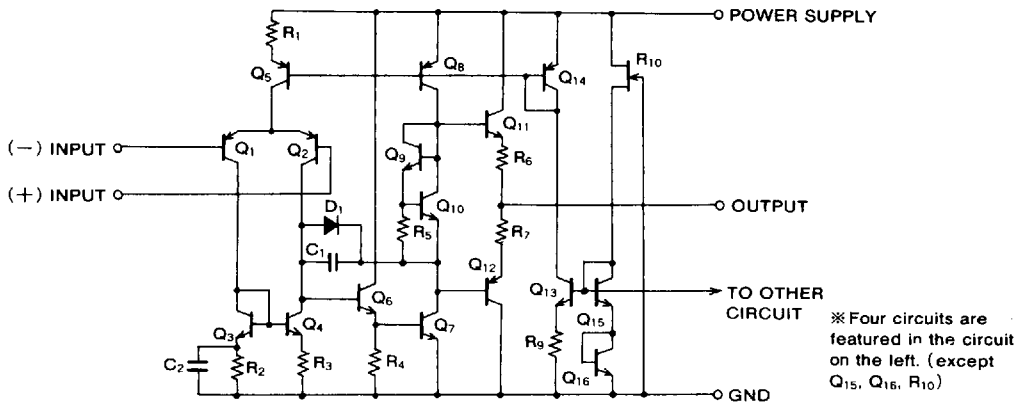

QUAD LOW-NOISE OPERATIONAL AMPLIFIERS (DUAL POWER SUPPLY TYPE)

ABSOLUTE MAXIMUM RATINGS ($T_a=25^\circ\text{C}$, unless otherwise noted)

Symbol	Parameter	Conditions	Ratings	Unit
V_{CC}	Supply voltage		± 18	V
I_{LP}	Load current		± 50	mA
V_{id}	Differential input voltage		± 30	V
V_{ic}	Common input voltage		± 15	V
P_d	Power dissipation		700(DIP)/550(FP)	mW
K_θ	Thermal derating	$T_a \geq 25^\circ\text{C}$	7(DIP)/5.5(FP)	mW/°C
T_{opr}	Ambient temperature		$-20 \sim +75$	°C
T_{stg}	Storage temperature		$-55 \sim +125$	°C

ELECTRICAL CHARACTERISTICS ($T_a=25^\circ\text{C}$, $V_{CC}=\pm 15\text{V}$)

Symbol	Parameter	Test conditions	Limits			Unit
			Min.	Typ.	Max.	
I_{CC}	Circuit current	$V_{in}=0$		6.0	12.0	mA
V_{IO}	Input offset voltage	$R_s \leq 10\text{k}\Omega$		0.5	6.0	mV
I_{IO}	Input offset current			5	200	nA
I_{IB}	Input bias current				500	nA
R_{in}	Input resistance		0.3	5		M Ω
G_{VO}	Open loop voltage gain	$R_L \geq 2\text{k}\Omega, V_o = \pm 10\text{V}$	86	110		dB
V_{OM}	Maximum output voltage	$R_L \geq 10\text{k}\Omega$	± 12	± 14		V
		$R_L \geq 2\text{k}\Omega$	± 10	± 13		
V_{CM}	Common input voltage range		± 12	± 14		V
CMRR	Common mode rejection ratio	$R_s \leq 10\text{k}\Omega$	70	90		dB
SVRR	Supply voltage rejection ratio	$R_s \leq 10\text{k}\Omega$		30	150	$\mu\text{V/V}$
P_d	Power dissipation			180	360	mW
SR	Slew rate	$G_v=0\text{dB}, R_L=2\text{k}\Omega$		2.2		V/ μs
f_T	Gain bandwidth product			7		MHz
V_{NI}	Input referred noise voltage	$R_s=1\text{k}\Omega, \text{BW}:10\text{Hz} \sim 30\text{kHz}$		2.0		μVrms

TYPICAL CHARACTERISTICS

THERMAL DERATING (MAXIMUM RATING)

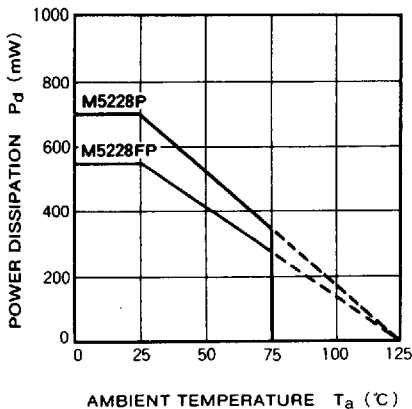

VOLTAGE GAIN VS. FREQUENCY RESPONSE

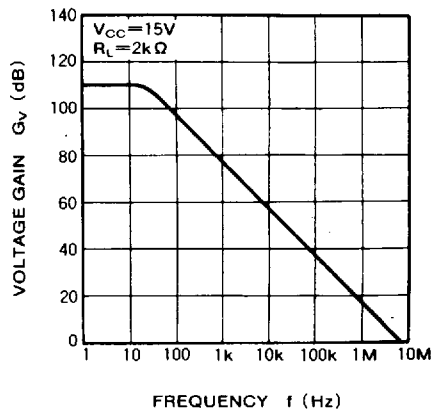

6249826 0021553 265

QUAD LOW-NOISE OPERATIONAL AMPLIFIERS (DUAL POWER SUPPLY TYPE)

CIRCUIT CURRENT VS. SUPPLY VOLTAGE

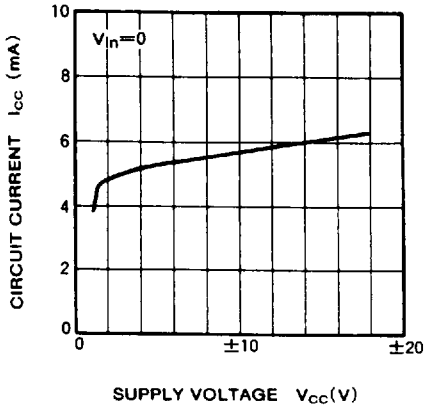

CIRCUIT CURRENT VS. AMBIENT TEMPERATURE

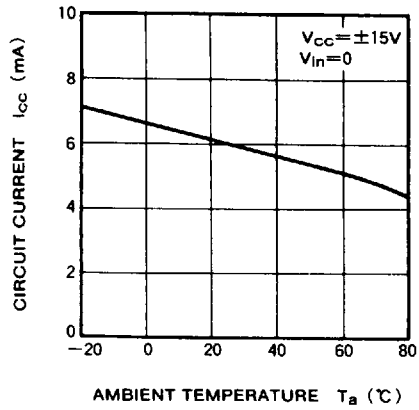

INPUT OFFSET VOLTAGE VS. AMBIENT TEMPERATURE

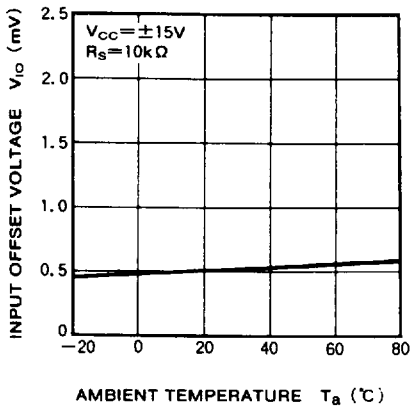

OUTPUT VOLTAGE / LOAD CURRENT PEAK VS. LOAD RESISTANCE

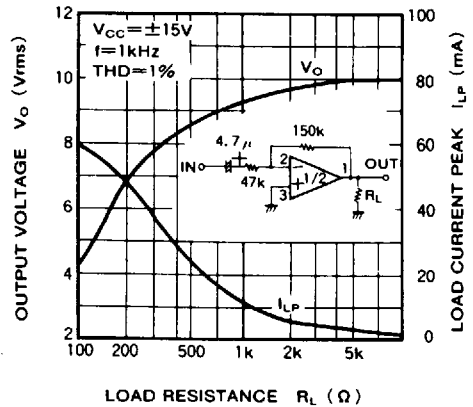

MAXIMUM OUTPUT VOLTAGE VS. SUPPLY VOLTAGE

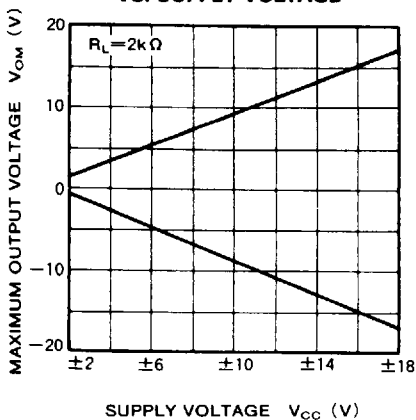

MAXIMUM OUTPUT VOLTAGE VS. FREQUENCY RESPONSE

