

PNP General Purpose Transistors

 Lead(Pb)-Free

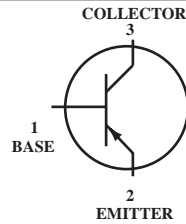

MAXIMUM RATINGS

Rating	Symbol	2907	2907A	Unit
Collector-Emitter Voltage	V_{CEO}	-40	-60	Vdc
Collector-Base Voltage	V_{CBO}		-60	Vdc
Emitter-Base Voltage	V_{EBO}		-5.0	Vdc
Collector Current-Continuous	I_C		-600	mAdc

THERMAL CHARACTERISTICS

Characteristics	Symbol	Max	Unit
Total Device Dissipation FR-5 Board (1) $T_A=25^\circ\text{C}$ Derate above 25°C	P_D	225 1.8	mW mW/ $^\circ\text{C}$
Thermal Resistance, Junction to Ambient	$R_{\theta JA}$	556	$^\circ\text{C/W}$
Total Device Dissipation Alumina Substrate, (2) $T_A=25^\circ\text{C}$ Derate above 25°C	P_D	300 2.4	mW mW/ $^\circ\text{C}$
Thermal Resistance, Junction to Ambient	$R_{\theta JA}$	417	$^\circ\text{C/W}$
Junction and Storage, Temperature	T_J, T_{stg}	-55 to +150	$^\circ\text{C}$

DEVICE MARKING

MMBT2907=M2B; MMBT2907A=2F

ELECTRICAL CHARACTERISTICS

Characteristics	Symbol	Min	Max	Unit
-----------------	--------	-----	-----	------

OFF CHARACTERISTICS

Collector-Emitter Breakdown Voltage ($I_C = -10 \text{ mAdc}, I_B = 0$)	MMBT2907 MMBT2907A	$V_{(BR)CEO}$	-40 -60	-	Vdc
Collector-Base Breakdown Voltage ($I_C = -10 \mu\text{Adc}, I_E = 0$)		$V_{(BR)CBO}$	-60	-	Vdc
Emitter-Base Breakdown Voltage ($I_E = -10 \mu\text{Adc}, I_C = 0$)		$V_{(BR)EBO}$	-5.0	-	Vdc
Collector Cutoff Current ($V_{CE} = -30 \text{ Vdc}, V_{EB}(\text{off}) = -0.5 \text{ Vdc}$)		I_{CEX}	-	-50	nAdc
Collector Cutoff Current ($V_{CB} = -50 \text{ Vdc}, I_E = 0$) ($V_{CB} = -50 \text{ Vdc}, I_E = 0, T_A = 125^\circ\text{C}$)	MMBT2907 MMBT2907A MMBT2907 MMBT2907A	I_{CBO}	-	-0.020 -0.010 -20 -10	nAdc
Base Cutoff Current ($V_{CE} = -30 \text{ Vdc}, V_{EB}(\text{off}) = -0.5 \text{ Vdc}$)	MMBT2907A	I_B	-	-50	nAdc

1.FR-5=1.0 x 0.75 x 0.062 in

2.Alumina=0.4 x 0.3 x 0.024 in. 99.5% alumina

ELECTRICAL CHARACTERISTICS ($T_A=25^\circ\text{C}$ unless otherwise noted) (Continued)

Characteristics	Symbol	Min	Max	Unit
-----------------	--------	-----	-----	------

ON CHARACTERISTICS

DC Current Gain ($I_C = -0.1 \text{ mAdc}, V_{CE} = -10 \text{ Vdc}$)	MMBT2907 MMBT2907A	h _{FE}	35 75	- -	
($I_C = -1.0 \text{ mAdc}, V_{CE} = -10 \text{ Vdc}$)	MMBT2907 MMBT22907A		50 100	- -	
($I_C = -10 \text{ mAdc}, V_{CE} = -10 \text{ Vdc}$)	MMBT2907 MMBT22907A		75 100	- -	
($I_C = -150 \text{ mAdc}, V_{CE} = -10 \text{ Vdc}$)	MMBT2907 MMBT2907A		100	300	
($I_C = -500 \text{ mAdc}, V_{CE} = -10 \text{ Vdc}$)	MMBT2907 MMBT2907A		30 50	- -	
Collector-Emitter Saturation Voltage ($I_C = -150 \text{ mAdc}, I_B = -15 \text{ mAdc}$) ($I_C = -500 \text{ mAdc}, I_B = -50 \text{ mAdc}$)		V _{CE(sat)}	- -	-0.4 -1.6	Vdc
Base-Emitter Saturation Voltage ($I_C = -150 \text{ mAdc}, I_B = -15 \text{ mAdc}$) ($I_C = -500 \text{ mAdc}, I_B = -50 \text{ mAdc}$)		V _{BE(sat)}	- -	-1.3 -2.6	Vdc

SMALL-SIGNAL CHARACTERISTICS

Current-Gain-Bandwidth Product (1),(2) ($I_C = -50 \text{ mAdc}, V_{CE} = -20 \text{ Vdc}, f = 100 \text{ MHz}$)	f _T	200	- -	MHz
Output Capacitance ($V_{CB} = -10 \text{ Vdc}, I_E = 0, f = 1.0 \text{ MHz}$)	C _{obo}	-	8.0	pF
Input Capacitance ($V_{EB} = -2.0 \text{ Vdc}, I_C = 0, f = 1.0 \text{ MHz}$)	C _{ibo}	-	30	pF

ELECTRICAL CHARACTERISTICS ($T_A=25^\circ\text{C}$ unless otherwise noted) (Continued)

Characteristics	Symbol	Min	Max	Unit
-----------------	--------	-----	-----	------

SWITCHING CHARACTERISTICS

Turn-On Time	(V _{CC} = -30 Vdc, I _C = -150 mAdc, I _{B1} = -15 mAdc)	t _{on}	-	45	ns
Delay Time		t _d	-	10	
Rise Time		t _r	-	40	
Turn-Off Time	(V _{CC} = -60 Vdc, I _C = -150 mAdc, I _{B1} = I _{B2} = -15 mAdc)	t _{off}	-	100	
Storage Time		t _s	-	80	
Fall Time		t _f	-	30	

1. Pulse Test: Pulse Width = 300 μs, Duty Cycle ≤ 2.0%.

2. f_T is defined as the frequency at which |h_{fe}| extrapolates to unity.

Typical Electrical Characteristics

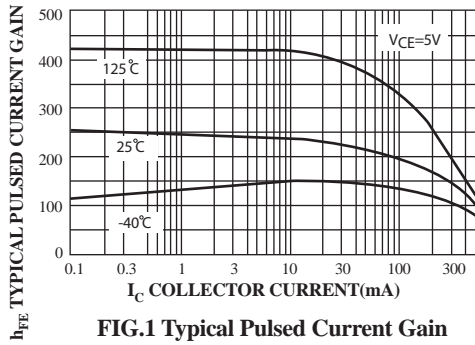

FIG.1 Typical Pulsed Current Gain vs Collector Current

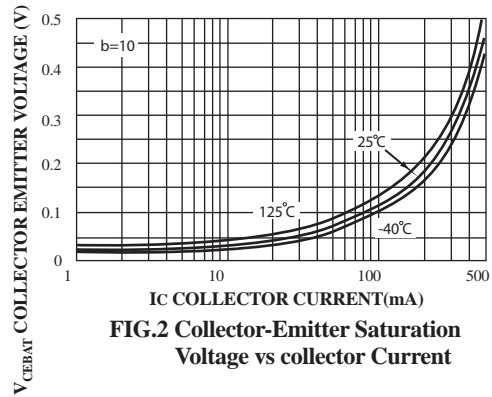

FIG.2 Collector-Emitter Saturation Voltage vs collector Current

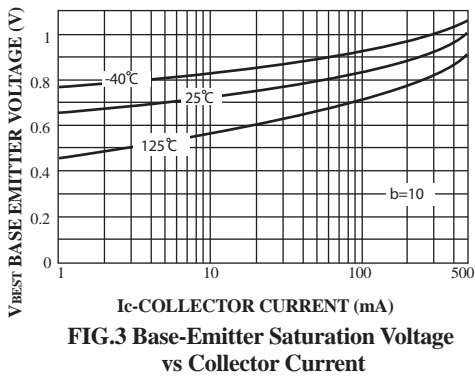

FIG.3 Base-Emitter Saturation Voltage vs Collector Current

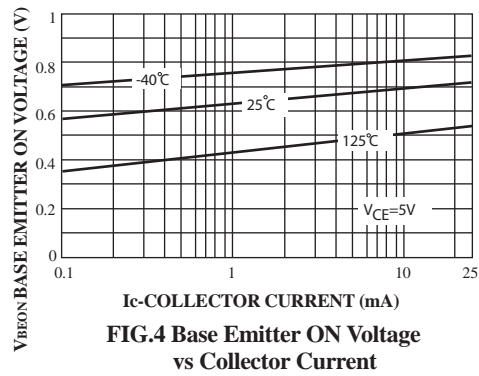

FIG.4 Base Emitter ON Voltage vs Collector Current

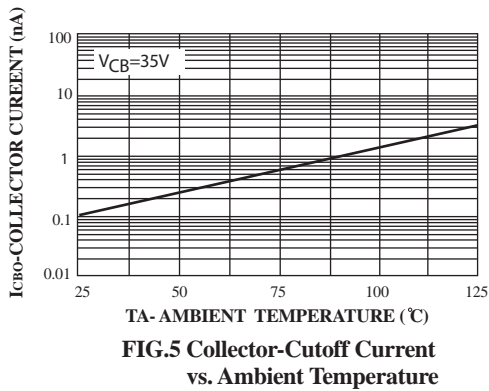

FIG.5 Collector-Cutoff Current vs Ambient Temperature

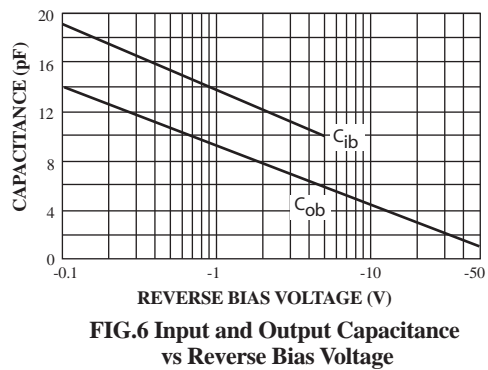

FIG.6 Input and Output Capacitance vs Reverse Bias Voltage

Typical Characteristics(Continued)

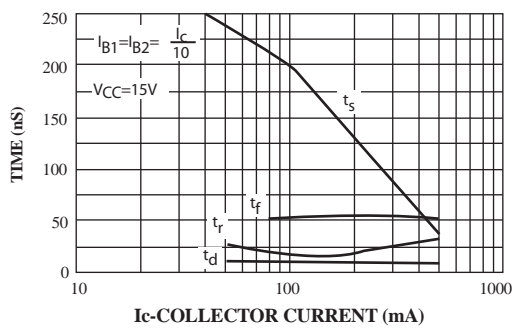

FIG.7 Switching Times vs Collector Current

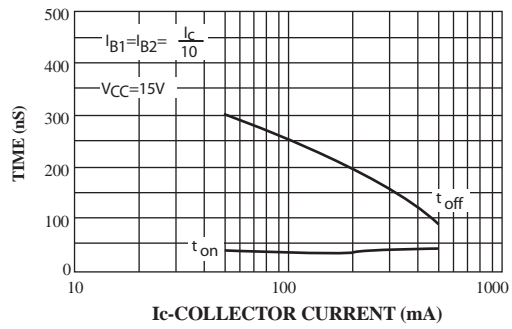

FIG.8 Turn On and Turn Off Times vs Collector Current

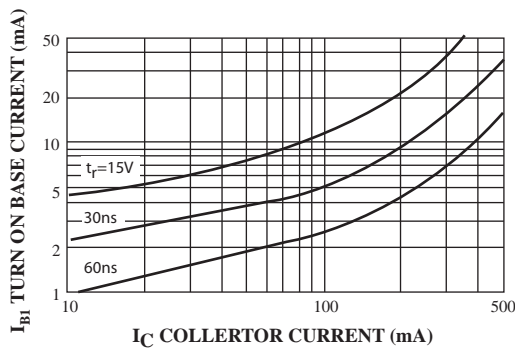

FIG.9 Rise Time vs Collector and Turn On Base Current

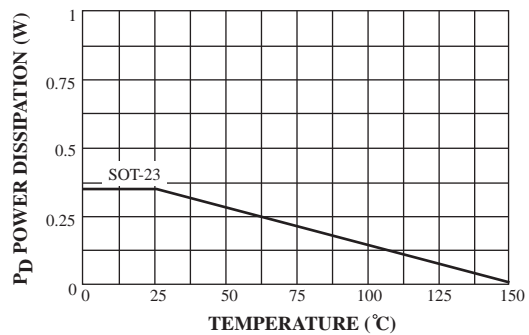

FIG.10 Power Dissipation vs Ambient Temperature

TEST CIRCUIT

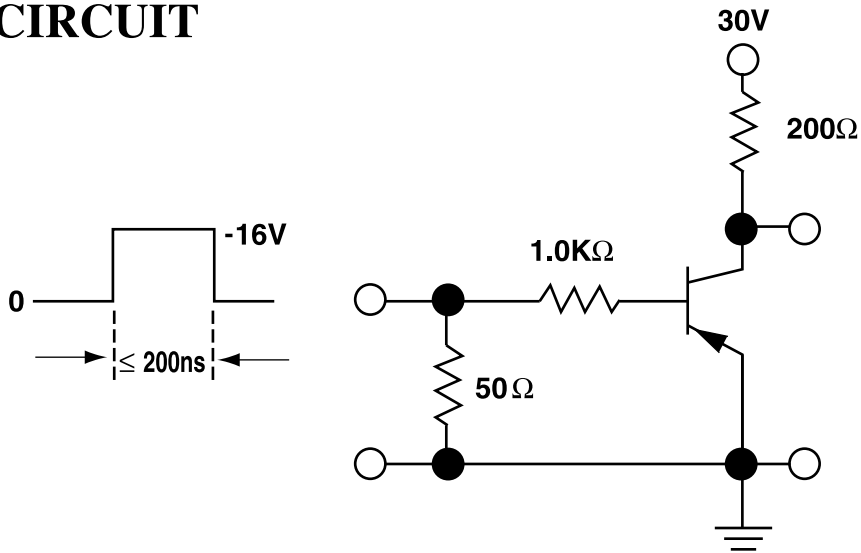

FIG.11 Saturated Turn-On Switching Time

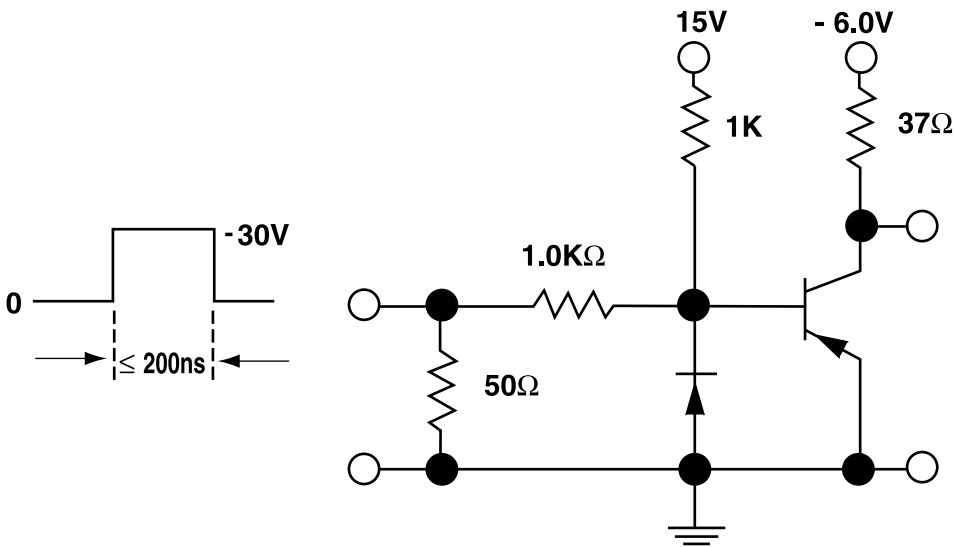
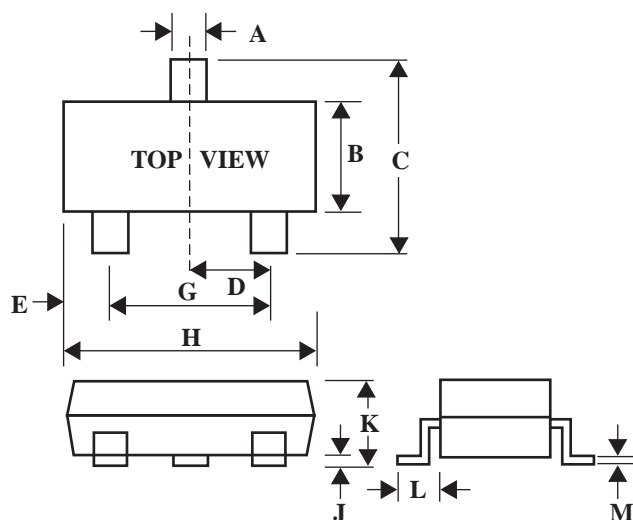

FIG.12 Saturated Turn-Off Switching Time

SOT-23 Package Outline Dimensions

Unit:mm



Dim	Min	Max
A	0.35	0.51
B	1.19	1.40
C	2.10	3.00
D	0.85	1.05
E	0.46	1.00
G	1.70	2.10
H	2.70	3.10
J	0.01	0.13
K	0.89	1.10
L	0.30	0.61
M	0.076	0.25