PAN101B CMOS OPTICAL NAVIGATION SENSOR

General Description

The PAN101B is a low cost CMOS process optical navigation sensor with DSP integration chip that serves as a non-mechanical motion estimation engine for implementing a computer mouse.

Features

- Single 3.0 volt power supply**
- Optical motion estimation technology**
- Complete 2-D motion sensor**
- No mechanical parts**
- Accurate motion estimation over a wide range of surfaces**
- High speed motion detection up to 16+ inches/sec**
- High resolution up to 800dpi**
- Shutdown pin for low power dissipation.**
- Power saving mode during times of no movement**
- Serial Interface for programming and data transfer**
- I/O pin 5.0 volt tolerance**

Key Specification

Power Supply	Wide operating supply range 2.7V~3.6V
Optical Lens	1:1
System Clock	18.432 MHz
Speed	16+ inches/sec
Resolution	400/800 dpi
Frame Rate	3000 frames/sec
Operating Current	<15mA @Mouse moving (Normal) < 5mA @Mouse not moving (sleep1) < 2mA @Mouse not moving (sleep2) < 100uA @Shutdown mode
Package	Shrunk DIP20

Ordering Information

Order number	I/O	Resolution
PAN101BOI-204	Open-drain output	400 dpi
PAN101BOI-208	Open-drain output	800 dpi
PAN101BSI-204	CMOS output	400 dpi
PAN101BSI-208	CMOS output	800 dpi

1. Pin Description

Pin No.	Name	Type	Definition
1	VSS_LED	GND	LED ground
2	LED	I/O	LED control
3	OSCOUT	OUT	Resonator output
4	OSCIN	IN	Resonator input
5	VSSD	GND	Chip digital ground
6	VSSA	GND	Chip analog ground
7	VDDD	PWR	Chip digital power VDD, 3.0V
8	VDDA	PWR	Chip analog power VDD, 3.0V
9	VRB	BYPASS	Analog voltage reference
10	VRT	BYPASS	Analog voltage reference
11	VAY	BYPASS	Analog voltage reference
12	XA	Open-drain OUT (PAN101BOI)	XA quadrature output
		CMOS OUT (PAN101BSI)	
13	NC	-	No connection
14	XB	Open-drain OUT (PAN101BOI)	XB quadrature output
		CMOS OUT (PAN101BSI)	
15	YA	Open-drain OUT (PAN101BOI)	YA quadrature output
		CMOS OUT (PAN101BSI)	
16	NC	-	No connection
17	YB	Open-drain OUT (PAN101BOI)	YB quadrature output
		CMOS OUT (PAN101BSI)	
18	SCLK	IN	Serial interface clock
19	SDIO	Open-drain I/O (PAN101BOI)	Serial interface bi-direction data
		CMOS I/O (PAN101BSI)	
20	PD	IN	Power down pin, active high

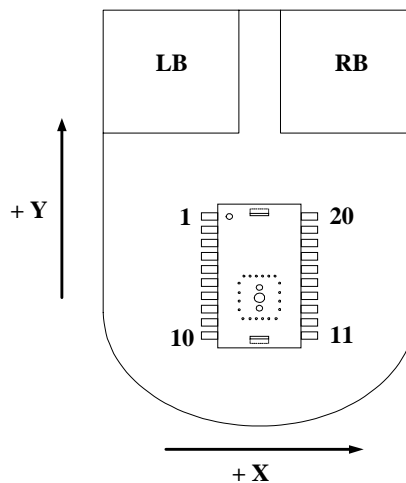
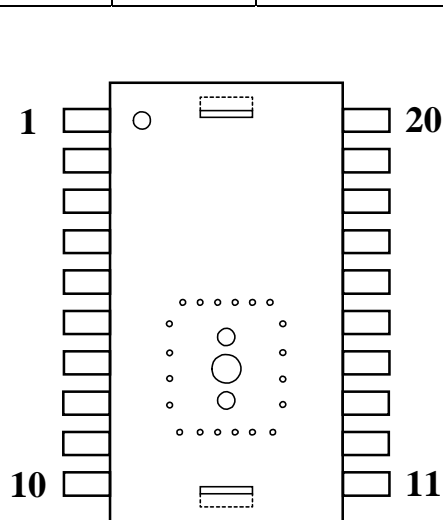

Figure 1. Top View Pinout

Figure 2. Top View of Mouse

2. Block Diagram and Operation

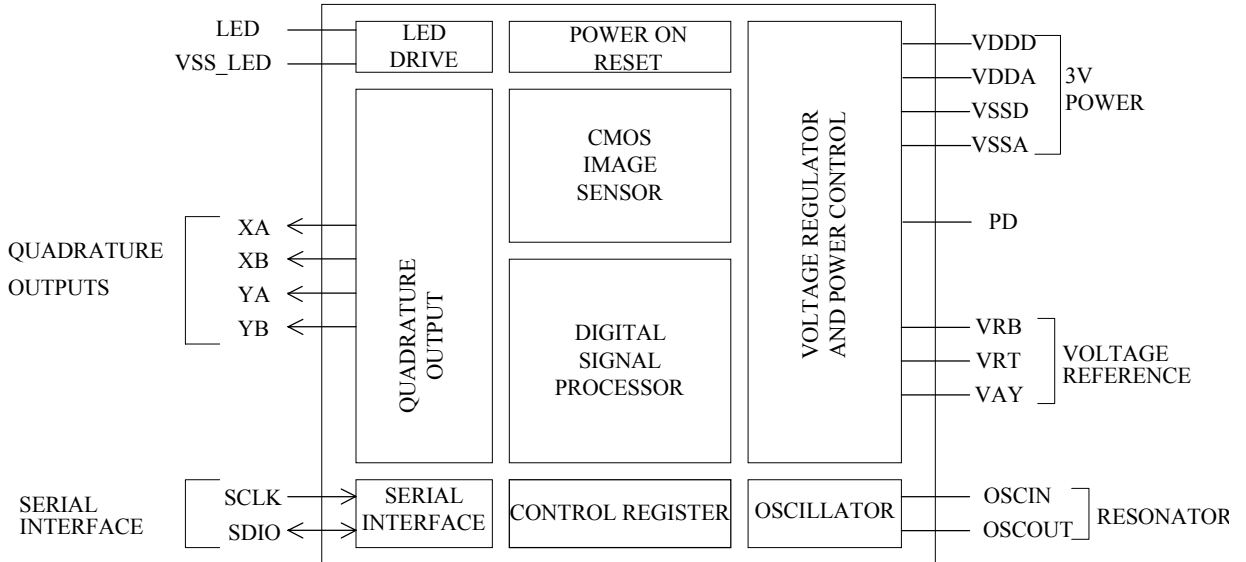

Figure 3. Block Diagram

The PAN101B is a low cost CMOS-process optical navigation sensor with DSP integration chip that serves as a non-mechanical motion estimation engine for implementing a computer mouse. It is based on optical navigation technology, which measures changes in position by optically acquiring sequential surface images (frames) and mathematically determining the direction and magnitude of movement. The sensor is in a 20 pin optical package. The output format is two-channel quadrature (X and Y direction), which emulates encoder phototransistors. The current X and Y information are also available in registers accessed via a serial port.

3. Registers and Operation

The PAN101B can be programmed through registers, via the serial port, and DSP configuration and motion data can be read from these registers. All registers not listed are reserved, and should never be written by firmware.

3.1 Registers

Address	Name	R/W	Default	Data Type
0x00	Product_ID	R	0x02	Eight bits number with the product identifier.
0x01	Reserved	-	-	Reserved for future.
0x02	Motion_Status	R	-	Bit field
0x03	Delta_X	R	-	Eight bits 2's complement number.
0x04	Delta_Y	R	-	Eight bits 2's complement number.
0x05	Operation_Mode	R/W	-	Bit field

3.2 Register descriptions

0x00	Product_ID							
Bit	7	6	5	4	3	2	1	0
Field	PID7	PID6	PID5	PID4	PID3	PID2	PID1	PID0
Usage	The value in this register can not change, it can be used to verify that the serial communications link is OK.							
0x01	Reserved							
Bit	7	6	5	4	3	2	1	0
Field	Reserved							
Usage	Reserved for future							

0x02	Motion_Status							
Bit	7	6	5	4	3	2	1	0
Field	Motion	Reserved	Reserved	DYOVF	DXOVF	Reserved	Reserved	RES
Usage	<p>Register 0x02 allows the user to determine if motion has occurred since the last time it was read. If so, then the user should read registers 0x03 and 0x04 to get the accumulated motion. It also tells if the motion buffers have overflowed since the last reading. The current resolution is also shown.</p> <p>Reading this register freezes the Delta_X and Delta_Y register values. Read this register before reading the Delta_X and Delta_Y registers. If Delta_X and Delta_Y are not read before the motion register is read a second time, the data in Delta_X and Delta_Y will be lost.</p>							
Notes	Field Name	Description						
	Motion	Motion since last report or PD 0 = No motion (Default) 1 = Motion occurred, data ready for reading in Delta_X and Delta_Y registers						
	Reserved	Reserved for future						
	Reserved	Reserved for future						
	DYOVF	Motion Delta Y overflow, ΔY buffer has overflowed since last report 0 = no overflow (Default) 1 = Overflow has occurred						
	DXOVF	Motion Delta X overflow, ΔX buffer has overflowed since last report 0 = no overflow (Default) 1 = Overflow has occurred						
	Reserved	Reserved for future						
	Reserved	Reserved for future						
	RES	Resolution in counts per inch 0 = 800 (Default @ PAN101BXX-208) 1 = 400 (Default @ PAN101BXX-204)						
0x03	Delta_X							
Bit	7	6	5	4	3	2	1	0
Field	X7	X6	X5	X4	X3	X2	X1	X0
Usage	X movement is counts since last report. Absolute value is determined by resolution. Reading clears the register. Report range -128~+127.							
0x04	Delta_Y							
Bit	7	6	5	4	3	2	1	0
Field	Y7	Y6	Y5	Y4	Y3	Y2	Y1	Y0
Usage	Y movement is counts since last report. Absolute value is determined by resolution. Reading clears the register. Report range -128~+127.							

0x05	Operation_Mode																									
Bit	7	6	5	4	3	2	1	0																		
Field	Reserved	XY_enh	RES	Slp_enh	Slp2au	Slp2mu	Slp1mu	Wakeup																		
Usage	<p>Register 0x05 allows the user to change the operation of the sensor. Shown below are the bits, their default values, and optional values.</p> <p>Operation_Mode[4:0] “0xxxx”=Disable sleep mode “10xxx”=Enable sleep mode¹ “11xxx”=Enable sleep mode² “1x100”=Force enter sleep2³ “1x010”=Force enter sleep1³ “1x001”=Force wakeup from sleep mode³</p> <p>Notes:</p> <ol style="list-style-type: none"> 1. Enable sleep mode, but disable automatic entering sleep2 mode, that is, only 2 modes will be used, normal mode and sleep1 mode. After 1 sec not moving during normal mode, the chip will enter sleep1 mode, and keep on sleep1 mode until moving is detected or wakeup is asserted. 2. Enable sleep mode full function, that is 3 modes will be used, normal mode, sleep1 mode and sleep2 mode. After 1 sec not moving during normal mode, chip will enter sleep1 mode, and keep on sleep1 mode until moving is detected or wakeup is asserted. <p>And after 90 sec not moving during sleep1 mode, the chip will enter sleep2 mode, and keep on sleep2 mode until detect moving or force wakeup to normal mode.</p> <table border="1"> <thead> <tr> <th>Mode</th> <th>Sampling rate @3000frame/sec</th> <th>Active duty cycle @3000frame/sec</th> </tr> </thead> <tbody> <tr> <td>Sleep1</td> <td>30/sec</td> <td>20%</td> </tr> <tr> <td>Sleep2</td> <td>3/sec</td> <td>2%</td> </tr> </tbody> </table> <ol style="list-style-type: none"> 3. Only one of these three bits slp2mu_enh, slp1mu_enh, and wakeup can be set to 1 at the same time, others have to be set to 0. After a period of time, the bits, which was set to 1, will be reset to 0 by internal signal. 								Mode	Sampling rate @3000frame/sec	Active duty cycle @3000frame/sec	Sleep1	30/sec	20%	Sleep2	3/sec	2%									
Mode	Sampling rate @3000frame/sec	Active duty cycle @3000frame/sec																								
Sleep1	30/sec	20%																								
Sleep2	3/sec	2%																								
Notes	<table border="1"> <thead> <tr> <th>Field Name</th> <th>Description</th> </tr> </thead> <tbody> <tr> <td>Reserved</td> <td>Reserved for future, Please set Reserved= “0” (Default)</td> </tr> <tr> <td>XY_enh</td> <td>XY quadrature output enable/disable 0=disable 1= enable (Default)</td> </tr> <tr> <td>RES</td> <td>Resolution in counts per inch 0 = 800 (Default @ PAN101BXX-208) 1 = 400 (Default @ PAN101BXX-204)</td> </tr> <tr> <td>Slp_enh</td> <td>Sleep mode enable/disable 0 = Disable 1 = Enable (Default)</td> </tr> <tr> <td>Slp2au</td> <td>Automatic enter sleep2 mode enable/disable 0 = Disable 1 = Enable (Default)</td> </tr> <tr> <td>Slp2mu</td> <td>Manual enter sleep2 mode, set “1” will enter sleep2 and this bit will be reset to “0”</td> </tr> <tr> <td>Slp1mu</td> <td>Manual enter sleep1 mode, set “1” will enter sleep2 and this bit will be reset to “0”</td> </tr> <tr> <td>Wakeup</td> <td>Manual wake up from sleep mode, set “1” will enter wakeup and this bit will be reset to “0”</td> </tr> </tbody> </table>								Field Name	Description	Reserved	Reserved for future, Please set Reserved= “0” (Default)	XY_enh	XY quadrature output enable/disable 0=disable 1= enable (Default)	RES	Resolution in counts per inch 0 = 800 (Default @ PAN101BXX-208) 1 = 400 (Default @ PAN101BXX-204)	Slp_enh	Sleep mode enable/disable 0 = Disable 1 = Enable (Default)	Slp2au	Automatic enter sleep2 mode enable/disable 0 = Disable 1 = Enable (Default)	Slp2mu	Manual enter sleep2 mode, set “1” will enter sleep2 and this bit will be reset to “0”	Slp1mu	Manual enter sleep1 mode, set “1” will enter sleep2 and this bit will be reset to “0”	Wakeup	Manual wake up from sleep mode, set “1” will enter wakeup and this bit will be reset to “0”
Field Name	Description																									
Reserved	Reserved for future, Please set Reserved= “0” (Default)																									
XY_enh	XY quadrature output enable/disable 0=disable 1= enable (Default)																									
RES	Resolution in counts per inch 0 = 800 (Default @ PAN101BXX-208) 1 = 400 (Default @ PAN101BXX-204)																									
Slp_enh	Sleep mode enable/disable 0 = Disable 1 = Enable (Default)																									
Slp2au	Automatic enter sleep2 mode enable/disable 0 = Disable 1 = Enable (Default)																									
Slp2mu	Manual enter sleep2 mode, set “1” will enter sleep2 and this bit will be reset to “0”																									
Slp1mu	Manual enter sleep1 mode, set “1” will enter sleep2 and this bit will be reset to “0”																									
Wakeup	Manual wake up from sleep mode, set “1” will enter wakeup and this bit will be reset to “0”																									

4. Specifications

Absolute Maximum Ratings

Symbol	Parameter	Min	Max	Unit	Notes
T _{STG}	Storage temperature	-40	85	°C	
T _A	Operating Temperature	-15	55	°C	
	Lead Solder Temp		260	°C	For 10 seconds, 1.6mm below seating plane.
V _{DD}	DC supply voltage	-0.5	4.0	V	
ESD			2	kV	All pins, human body model MIL 883 Method 3015
V _{IN}	DC input voltage	-0.5	5.5	V	PD, SDIO, SCLK, XA, XB, YA, YB

Recommend Operating Condition

Symbol	Parameter	Min.	Typ.	Max.	Unit	Notes
T _A	Operating Temperature	0		40	°C	
V _{DD}	Power supply voltage	2.7	3.0	3.6	V	
V _N	Supply noise			100	mV	Peak to peak within 0-100 MHz
F _{CLK}	Clock Frequency		18.432	24.576	MHz	Set by ceramic resonator
FR	Frame Rate		3000	4000	Frames/s	4000Frames/s @ F _{CLK} =24.567MHz
SCLK	Serial Port Clock Frequency			F _{CLK} /4	MHz	
Z	Distance from lens reference plane to surface	2.1	2.2	2.3	mm	Refer to Figure 4.
S	Speed	0	16		in/sec	
A	Acceleration			3.9	g	
R	Resolution		400	800	cpi	

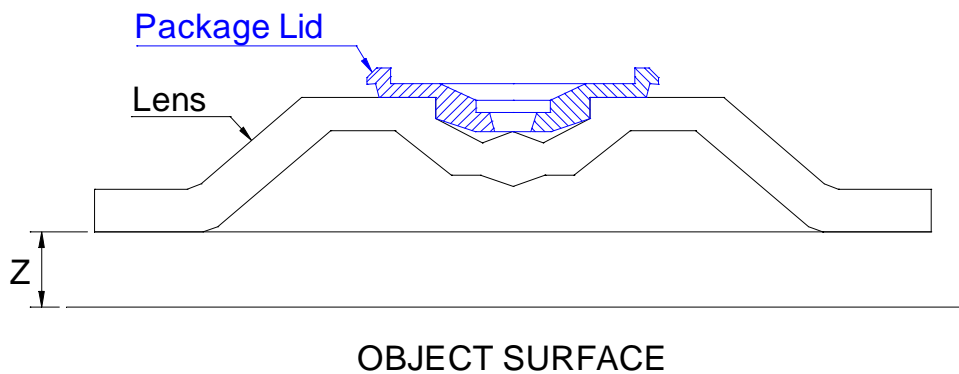

Figure 4. Distance from Lens Reference Plane to Surface

AC Operating ConditionElectrical Characteristics over recommended operating conditions. Typical values at 25 °C, $V_{DD}=3.0$ V

Symbol	Parameter	Min.	Typ.	Max.	Unit	Notes
t_{PD}	Power Down		0.5		us	From PD \uparrow . (Refer to Figure 5.)
t_{PDW}	PD Pulse Width	1			us	Pulse width to reset the serial interface. (Refer to Figure 5.)
t_{PUPD}	Power Up from PD \downarrow			42.8	ms	From PD \downarrow to valid quad signals 200usec + 128frames. (Refer to Figure 5.)
t_{PU}	Power Up from $V_{DD}\uparrow$			41.7	ms	From $V_{DD}\uparrow$ to valid quad signals. 400usec + 124frames.
t_{HOLD}	SDIO read hold time		3		us	Minimum hold time for valid data. (Refer to Figure 14.)
$t_{COMPUTE}$	Data delay after PD \downarrow	4			ms	After $t_{COMPUTE}$, all registers contain valid data from first image after PD \downarrow . Note that an additional 128 frames for Auto-Exposure (AE) stabilization may be required if mouse movement occurred while PD was high. (Refer to Figure 8.)
t_r, t_f	Rise and Fall Times: SDIO		500, 5		ns	Pull-up 10Kohm (PAN101BOI)
			25, 20		ns	$C_L = 30$ pf (PAN101BSI)
t_r, t_f	Rise and Fall Times: XA, XB, YA, YB		500, 5		ns	Pull-up 10Kohm (PAN101BOI)
			25, 20		ns	$C_L = 30$ pf (PAN101BSI)
t_r, t_f	Rise and Fall Times: ILED		10, 10		ns	LED bin:N ; R1=100ohm

DC Electrical CharacteristicsElectrical Characteristics over recommended operating conditions. Typical values at 25 °C, V_{DD} = 3.0 V

Symbol	Parameter	Min.	Typ.	Max.	Unit	
Type: PWR						
I _{DD}	Supply Current Mouse moving (Normal)		15		mA	XA, XB, YA, YB, SCLK, SDIO = no load
I _{DD}	Supply Current Mouse not moving (sleep1)		5		mA	
I _{DD}	Supply Current Mouse not moving (sleep2)		2		mA	
I _{DDPD}	Supply Current (Power Down)		100		uA	PD, SCLK, SDIO = high
Type: SCLK, SDIO, PD						
V _{IH}	Input voltage HIGH	2				
V _{IL}	Input voltage LOW			0.8	V	
V _{OH}	Output voltage HIGH	0.8 V _{DD}			V	@I _{OH} = 3mA (SDIO only)
V _{OL}	Output voltage LOW			0.2V _{DD}	V	@I _{OL} = 3mA (SDIO only)
Type: OSCIN						
V _{IH}	Input voltage HIGH	2			V	When driving from an external source
V _{IL}	Input voltage LOW			0.8	V	When driving from an external source
Type: LED						
V _{OL}	Output voltage LOW			150	mV	@I _{OL} = 25mA
Type: XA, XB, YA, YB						
V _{OH}	Output voltage HIGH	0.8 V _{DD}			V	@I _{OH} = 3mA
V _{OL}	Output voltage LOW			0.2V _{DD}	V	@I _{OL} = 3mA

5. PD Pin Timing

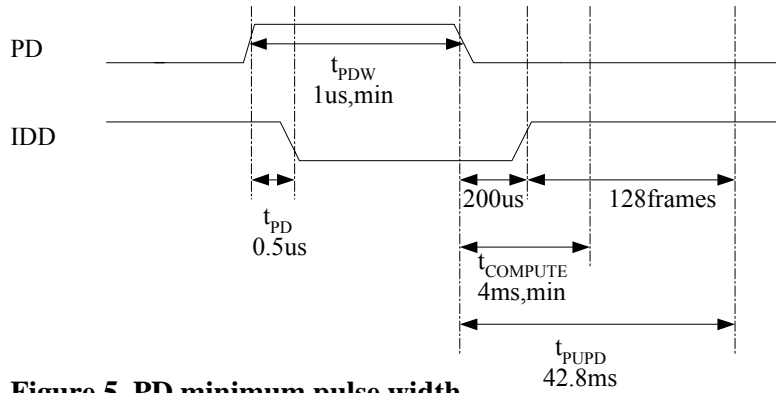

Figure 5. PD minimum pulse width

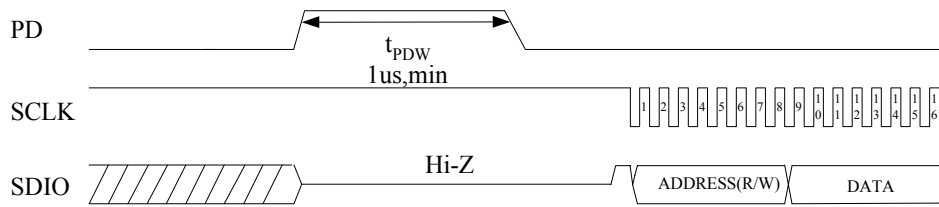

Figure 6. Forcing PAN101B SDIO line to the Hi-Z state

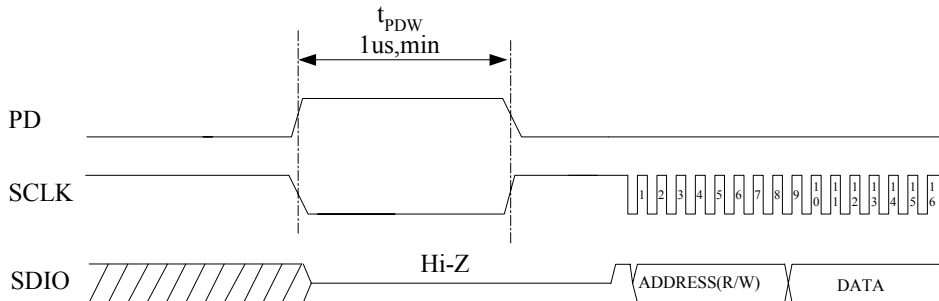

Figure 7. Forcing PAN101B full chip reset and SDIO line to the Hi-Z state

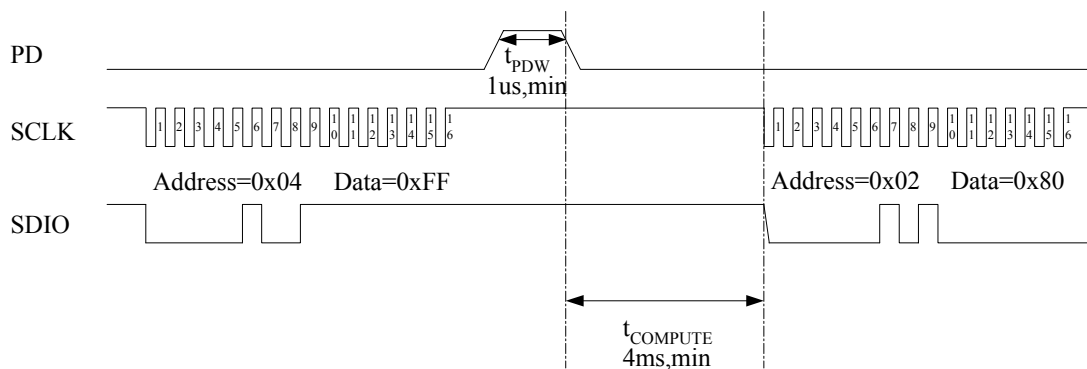

Figure 8. Read the motion data from PAN101B

6. Quadrature Mode

The quadrature state of the PAN101B tells mouse controller which direction the mouse is moving in. The output format is two channels quadrature (X and Y direction), which emulates encoder phototransistors. The DSP generates the Δx and Δy relative displacement values that are converted into two channel quadrature signals. PAN101B support 400cpi, 800cpi, two types of resolution. The following diagrams show the timing for positive X motion, to the right or positive Y motion, up.

6.1 Quadrature Output Timing

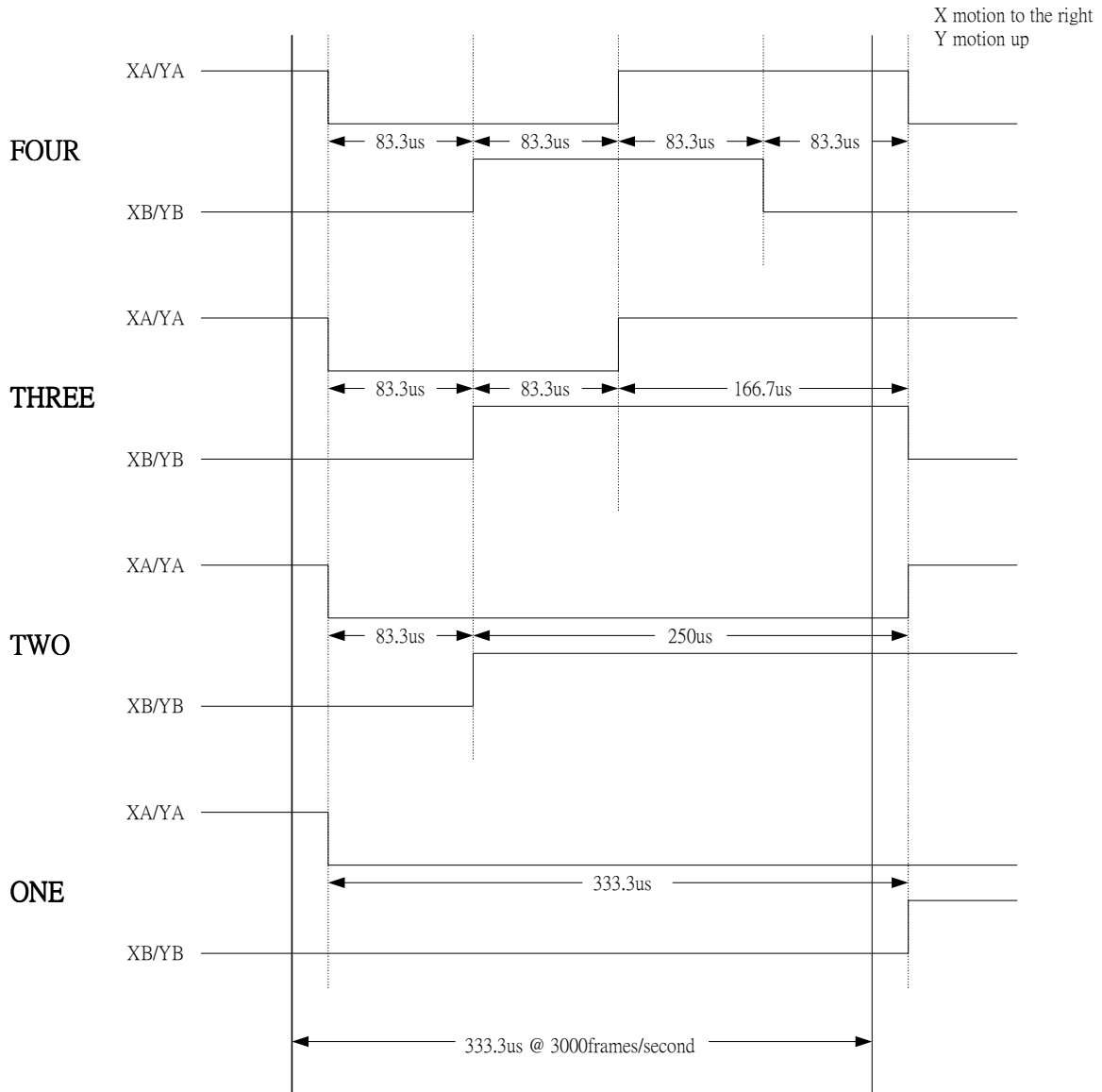

Figure 9. Quadrature Output Timing

6.2 Quadrature Output State Machine

The following state machine shows the states of the quadrature output pins. The three things to note are that state 0 is entered after a power on reset. While the PD pin is asserted, the state machine is halted. Once PD is de-asserted, the state machine picks up from where it left off. During times of mouse no movement will entry power saving mode, until mouse was moved.

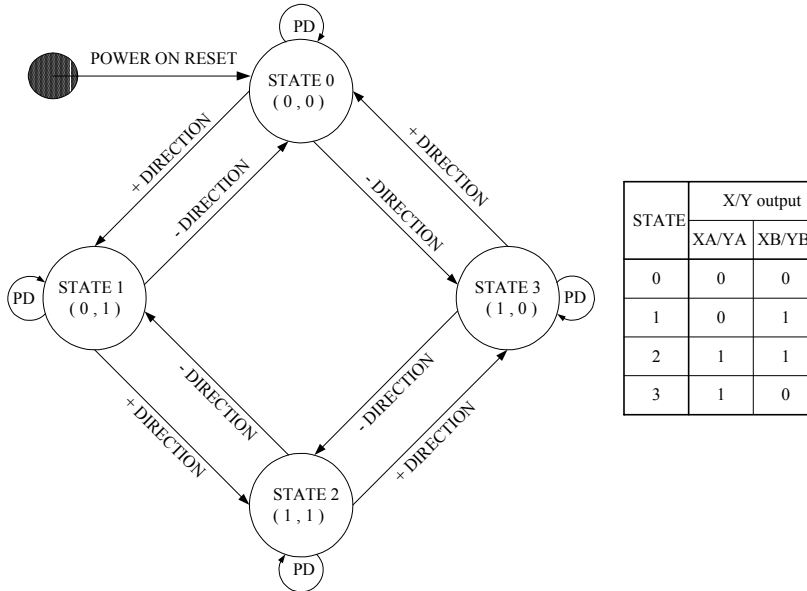

Figure 10. State Machine

6.3 Quadrature Output Waveform

The following diagrams show the waveform of the two channel quadrature outputs. If the X, Y is motionless, the (XA, XB), (YA, YB) will keep in final state. Each state change (ex. STATE2 → STATE3) is one count.

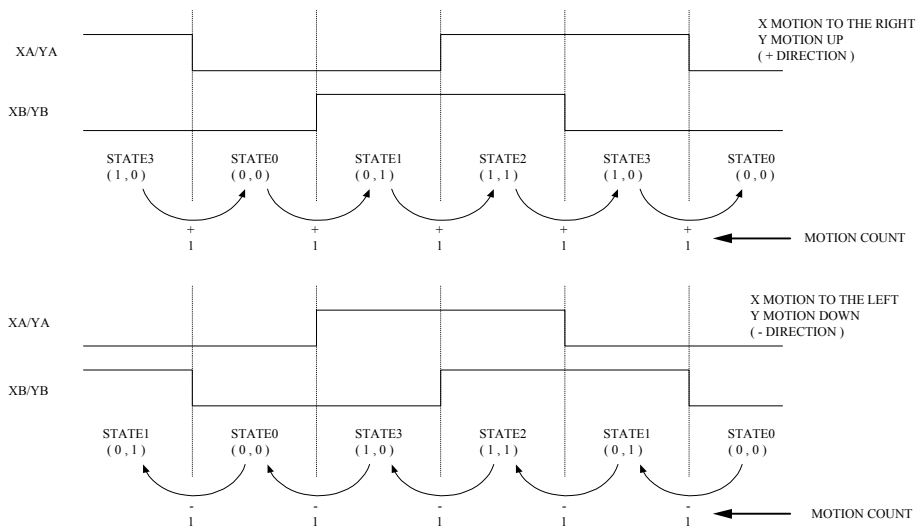

Figure 11. Quadrature Output Waveform

7. Serial Interface

The synchronous serial port is used to set and read parameters in the PAN101B, and can be used to read out the motion information instead of the quadrature data pins.

SCLK: The serial clock line. It is always generated by the host micro-controller.

SDIO: The serial data line used for write and read data.

PD: A third line is sometimes involved. PD (Power Down pin) is usually used to place the PAN101B in a low power mode to meet USB suspend specification. PD can also be used to force re-synchronization between the micro-controller and the PAN101B in case of an error.

7.1 Transmission Protocol

The transmission protocol is a two-wire link, half duplex protocol between the micro-controller and PAN101B. All data changes on SDIO are initiated by the falling edge on SCLK. The host micro-controller always initiates communication; the PAN101B never initiates data transfers.

The transmission protocol consists of the two operation modes:

- Write Operation.
- Read Operation.

Both of the two operation modes consist of two bytes. The first byte contains the address (seven bits) and has a bit7 as its MSB to indicate data direction. The second byte contains the data.

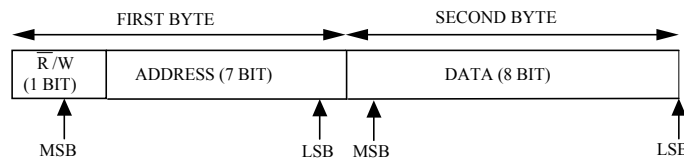

Figure 12. Transmission Protocol

7.1.1 Write Operation

A write operation, which means that data is going from the micro-controller to the PAN101B, is always initiated by the micro-controller and consists of two bytes. The first byte contains the address (seven bits) and has a “1” as its MSB to indicate data direction. The second byte contains the data. The transfer is synchronized by SCLK. The micro-controller changes SDIO on falling edges of SCLK. The PAN101B reads SDIO on rising edges of SCLK.

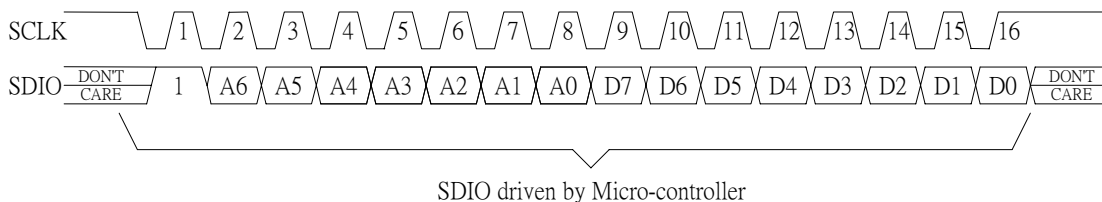

Figure 13. Write Operation

7.1.2 Read Operation

A read operation, which means that data is going from the PAN101B to the micro-controller, is always initiated by the micro-controller and consists of two bytes. The first byte contains the address, is written by the micro-controller, and has a “0” as its MSB to indicate data direction. The second byte contains the data and is driven by the PAN101B. The transfer is synchronized by SCLK. SDIO is changed on falling edges of SCLK and read on every rising edge of SCLK. The micro-controller must go to a high Z state after the last address data bit. The PAN101B will go to the high Z state after the last data bit.

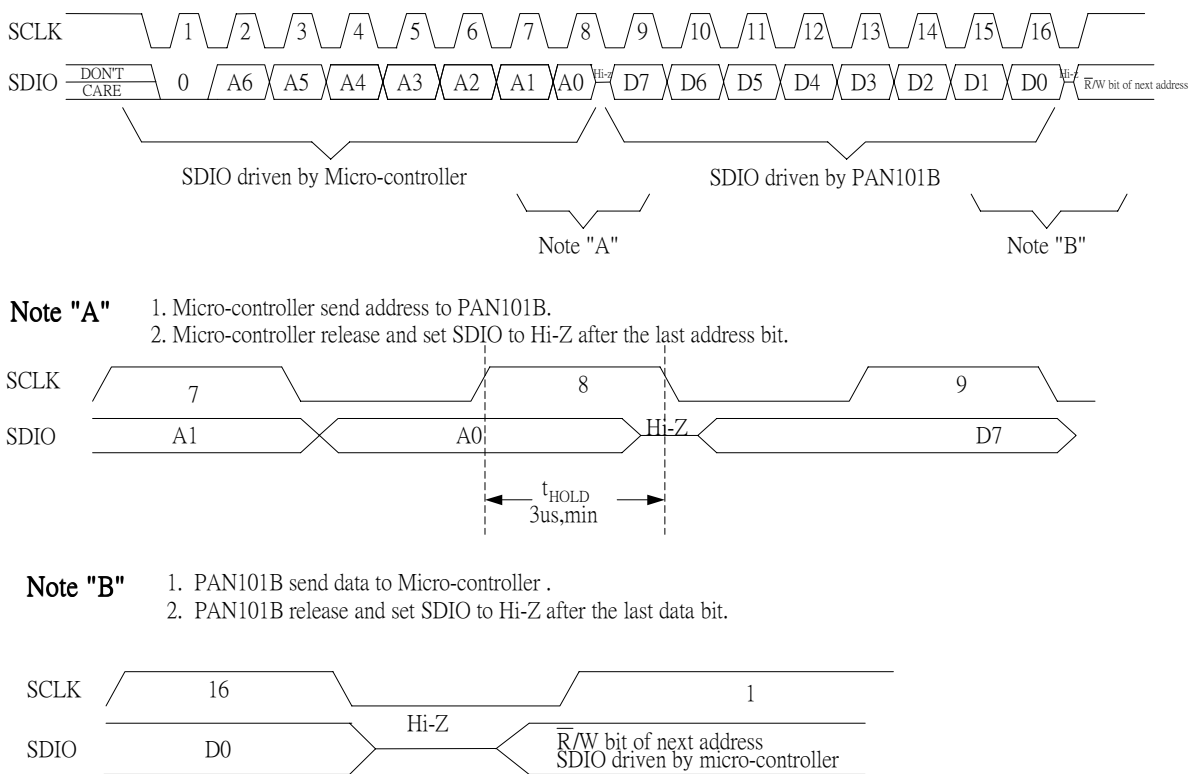

Figure 14. Read Operation

7.2 Re-Synchronous Serial Interface

There are times when the SDIO line from the PAN101B should be in the Hi-Z state. If the microprocessor has completed a write to the PAN101B, the SDIO line is Hi-Z, since the SDIO pin is still configured as an input. However, if the last operation from the microprocessor was a read, the PAN101B will hold the D0 state on SDIO until a rising edge of SCLK. To place the SDIO pin into the Hi-Z state, first raise the PD pin, and then toggle the SCLK line from high to low. The SDIO line will now be in the Hi-Z state. The PAN101B and the micro-controller might get out of synchronization due to following condition.

7.2.1 USB suspend

Termination of a transmission by the micro-controller may sometimes be required (for example, due to a USB suspend interrupt during a read operation). To accomplish this the micro-controller should raise PD. The PAN101B will not write to any register and will reset the serial port (but nothing else) and be prepared for the beginning of future transmissions after PD goes low.

7.2.2 Firmware flaws error, or others error

The PAN101B and the micro-controller might get out of synchronization due to micro-controller firmware flaws. The PD pin can stay high, with the PAN101B in the shutdown state, or the PD pin can be lowered, returning the PAN101B to normal operation.

If the microprocessor and the PAN101B get out of sync, then the data either written or read from the registers will be incorrect. In such a case, an easy way to solve this is to raise PD to re-sync the parts after an incorrect read. The PAN101B will reset the serial port but will not reset the registers and be prepared for the beginning of a new transmission

7.2.3 Power on problem

The problem occurs if the PAN101B powers up before the microprocessor sets the SCLK and SDIO lines to be output.

7.2.4 ESD events

The PAN101B and the micro-controller might get out of synchronization due to ESD events.

If the PAN101B and the micro-controller might get out of synchronization due to power on problem or ESD events. An easy way to solve this is to reset PAN101B.

Power on reset to resync PAN101B
 => Reset full chip and SDIO line set to Hi-Z state)

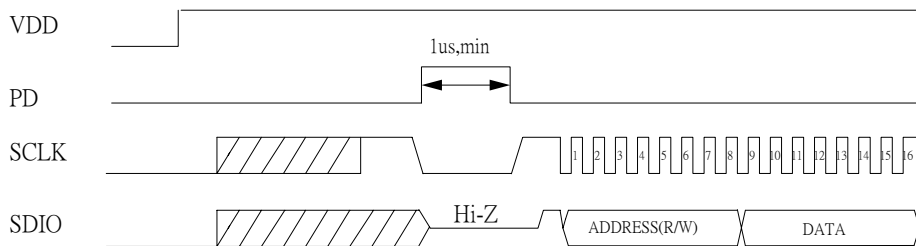

Figure 15. Power on reset to resync. PAN101B

7.3 Collision detection on SDIO

The only time that the PAN101B drives the SDIO line is during a READ operation. To avoid data collisions, the micro-controller should release SDIO before the falling edge of SCLK after the last address bit. The PAN101B begins to drive SDIO after the next falling edge of SCLK. The PAN101B release SDIO of the rising SCLK edge after the last data bit. The micro-controller can begin driving SDIO any time after that. In order to maintain low power consumption in normal operation or when the PD pin is pulled high, the micro-controller should not leave SDIO floating until the next transmission (although that will not cause any communication difficulties).

7.4 Error detection and recovery

1. The micro-controller can verify success of write operations by issuing a read command to the same address and comparing written data to read data.
2. The micro-controller can verify the synchronization of the serial port by periodically reading the product ID register.

8. Referencing application circuit

8.1 Recommended typical application using serial interface

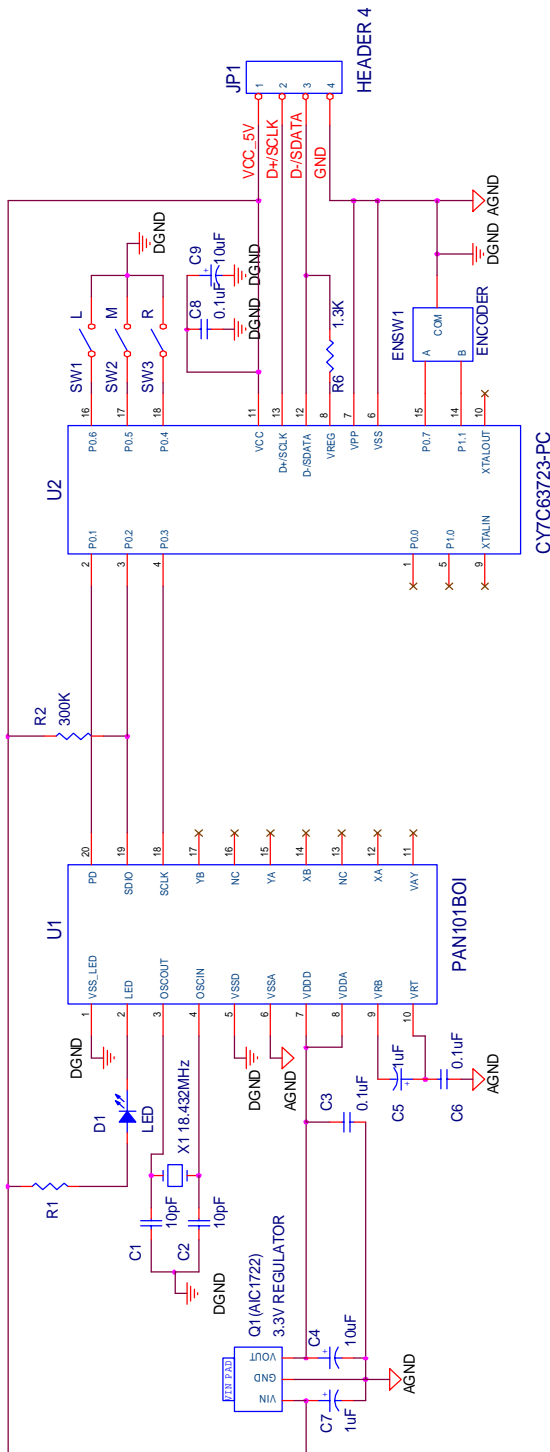

Figure 16. Application circuit using serial interface with PAN101BOI

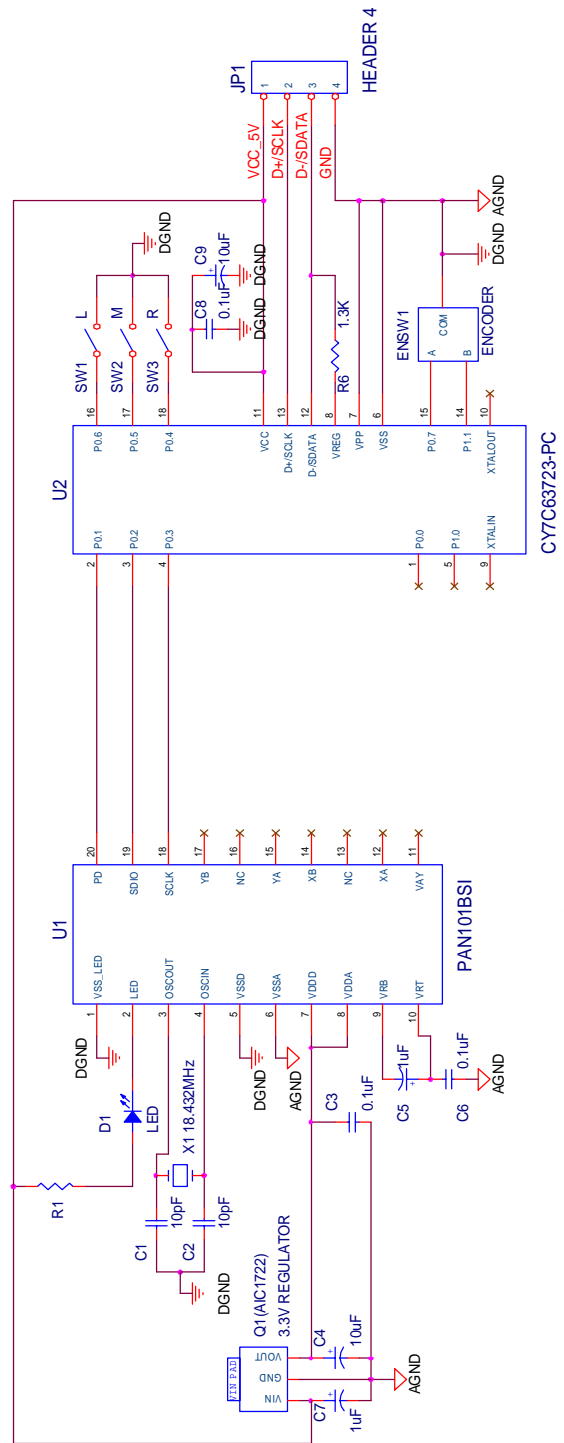

Figure 17. Application circuit using serial interface with PAN101BSI

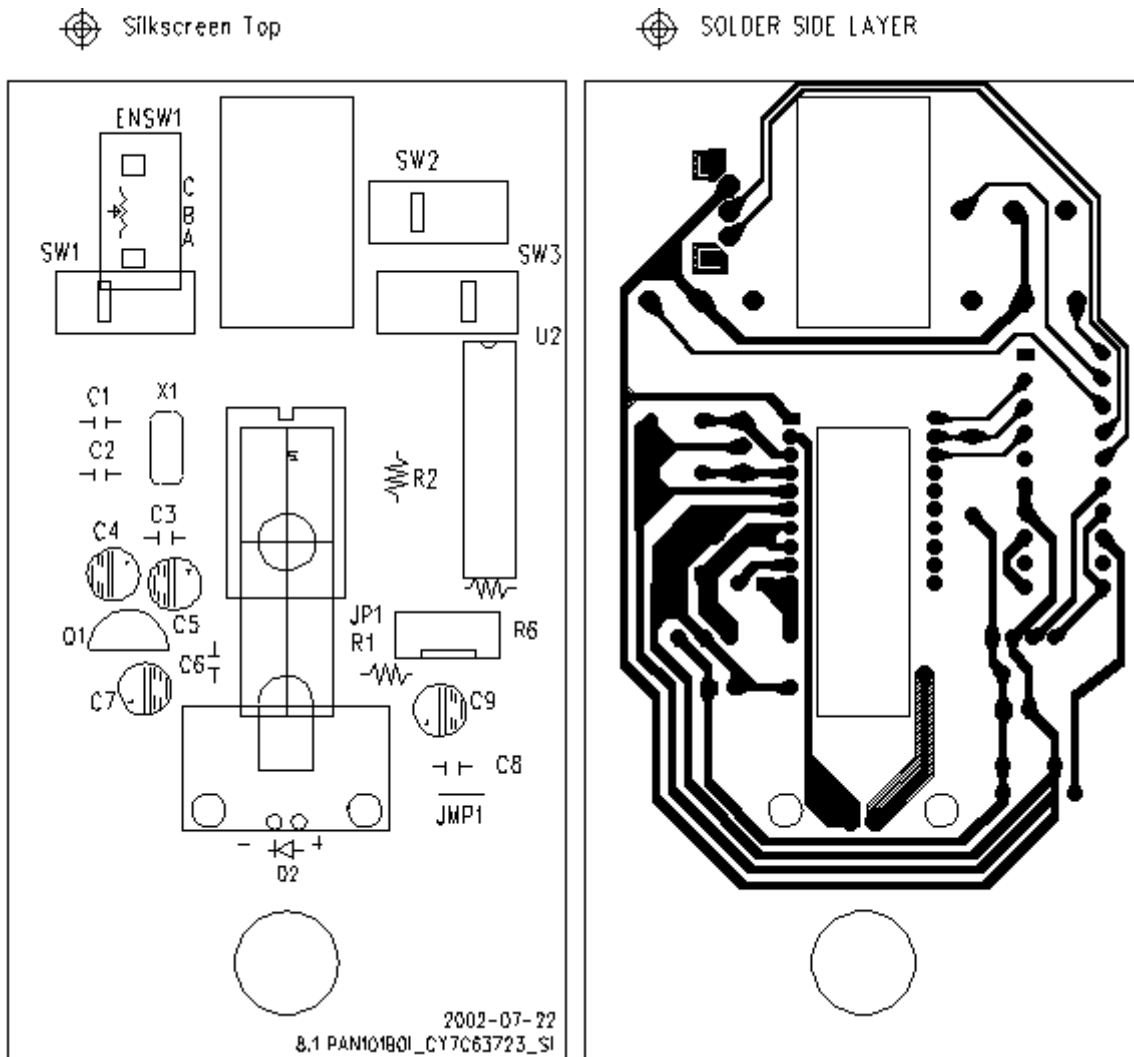

Figure 18. Example printed circuit board layout. (PAN101BOI V.S CY7C63723-PC)

8.2 Application circuit using quadrature output pins

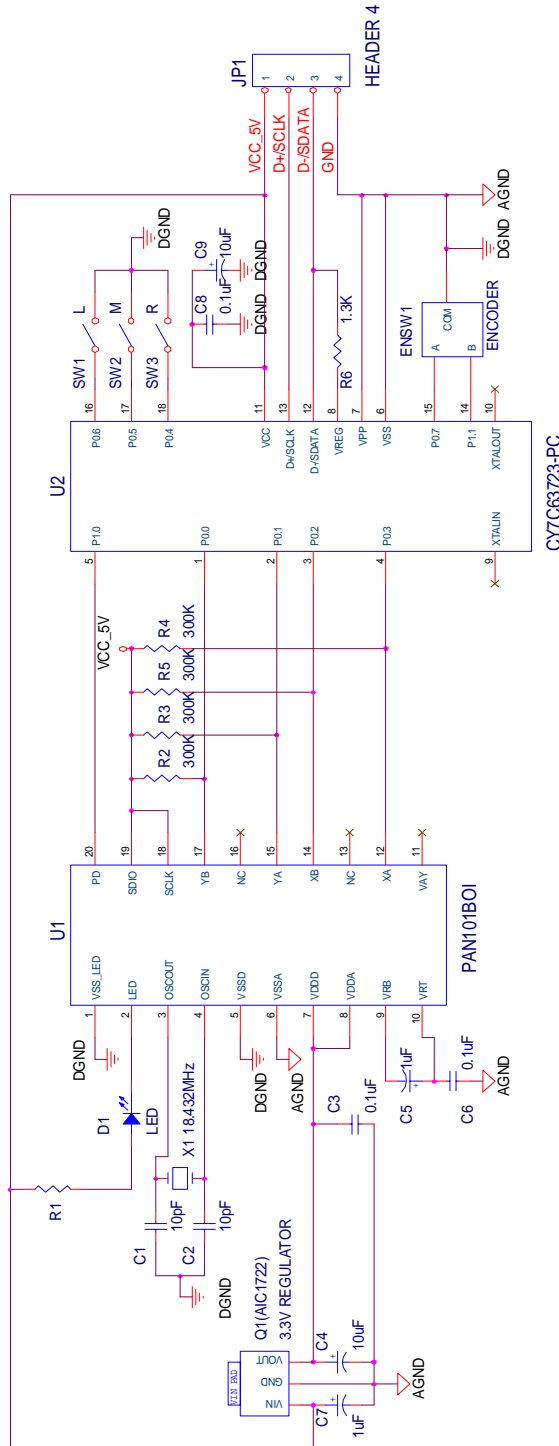

Figure 19. Application circuit using quadrature output pins with PAN101BOI

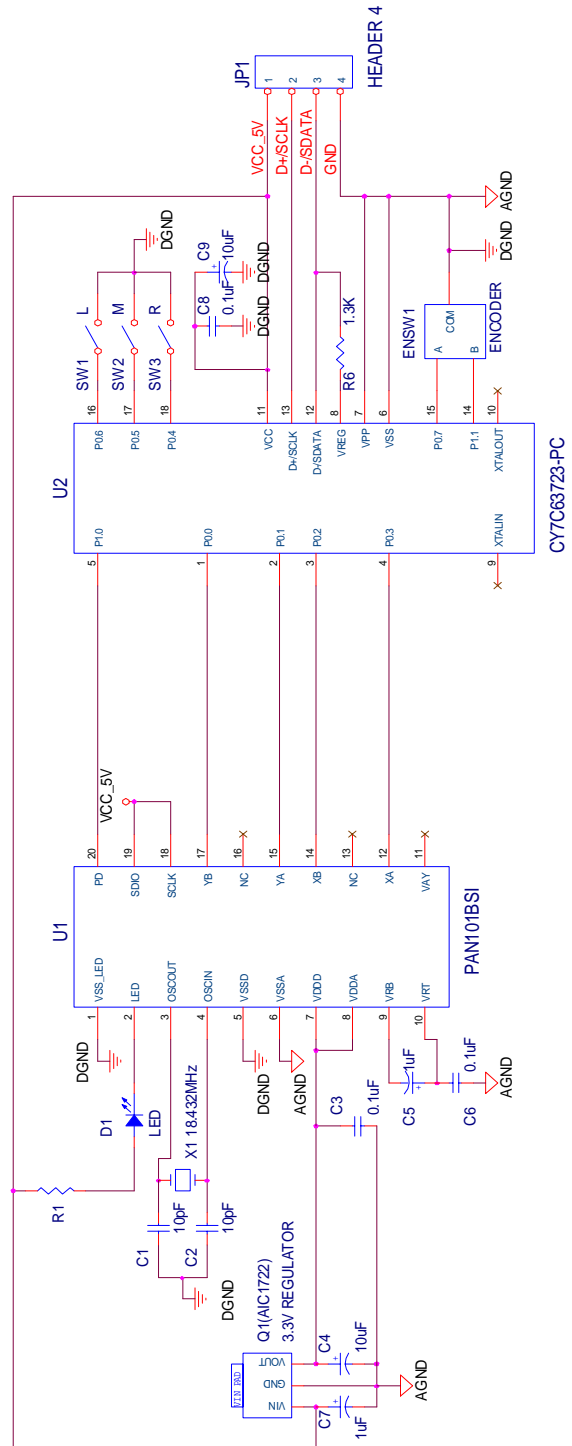

Figure 20. Application circuit using quadrature output pins with PAN101BSI

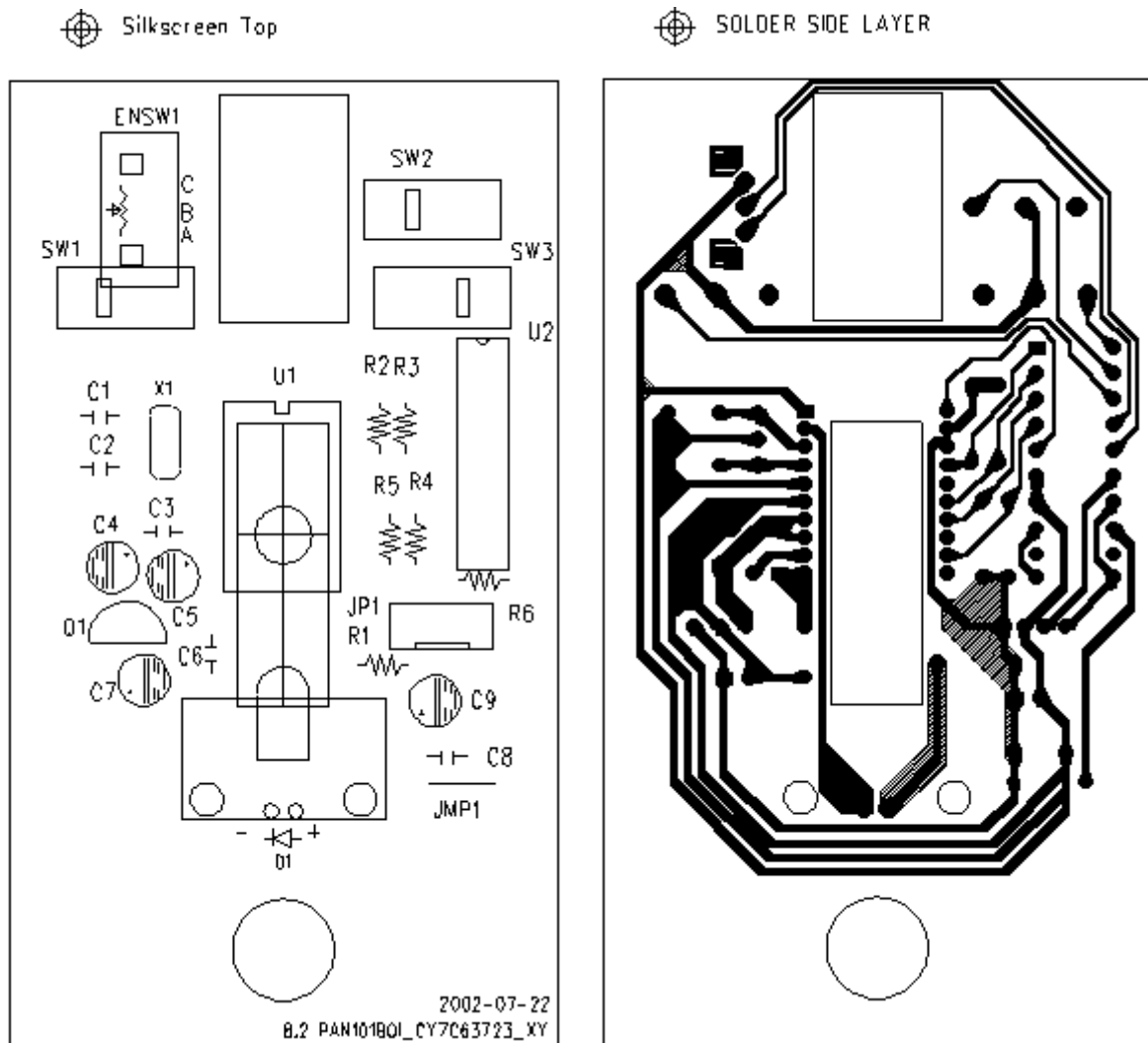

Figure 21. Example printed circuit board layout. (PAN101BOI V.S CY7C63723-PC)

8.3 Typical application for PS/2 interface

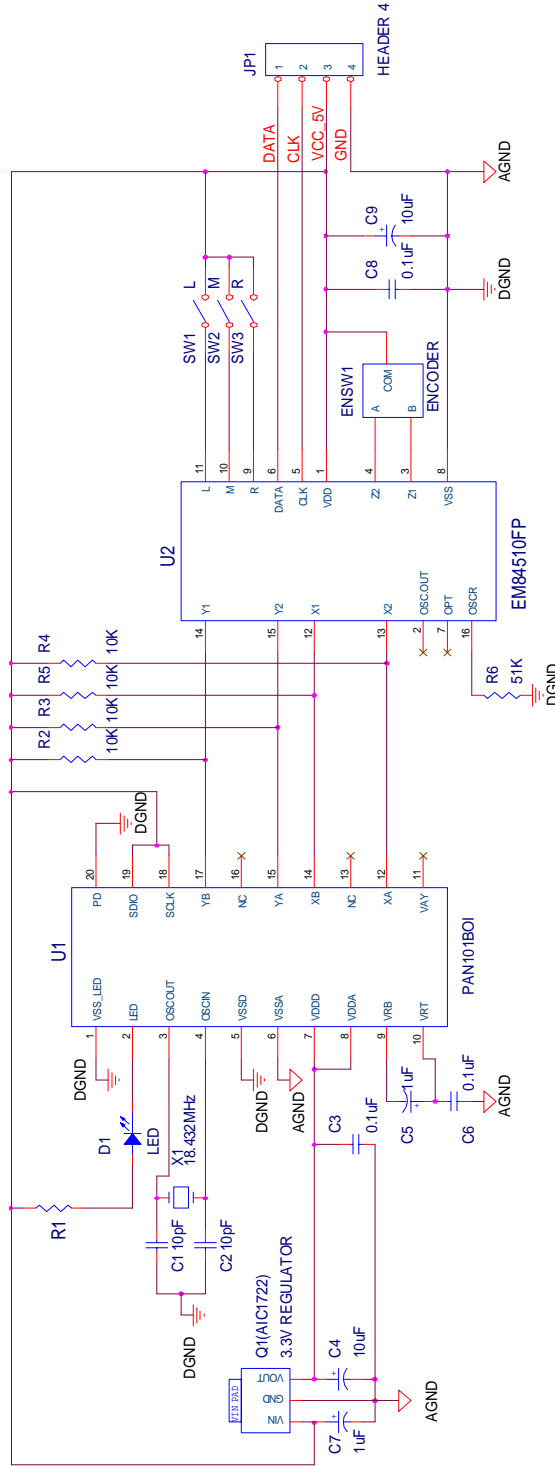

Figure 22. Application circuit using PS/2 interface with PAN101B01

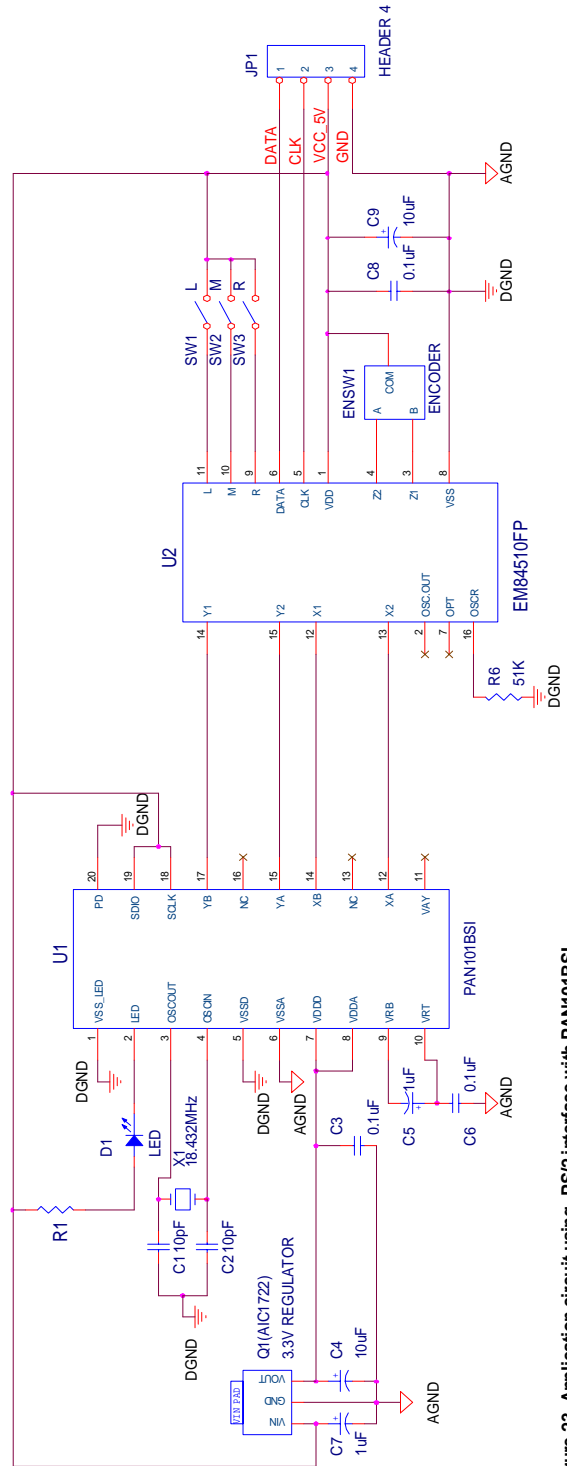

Figure 23. Application circuit using PS/2 interface with PAN101BS1

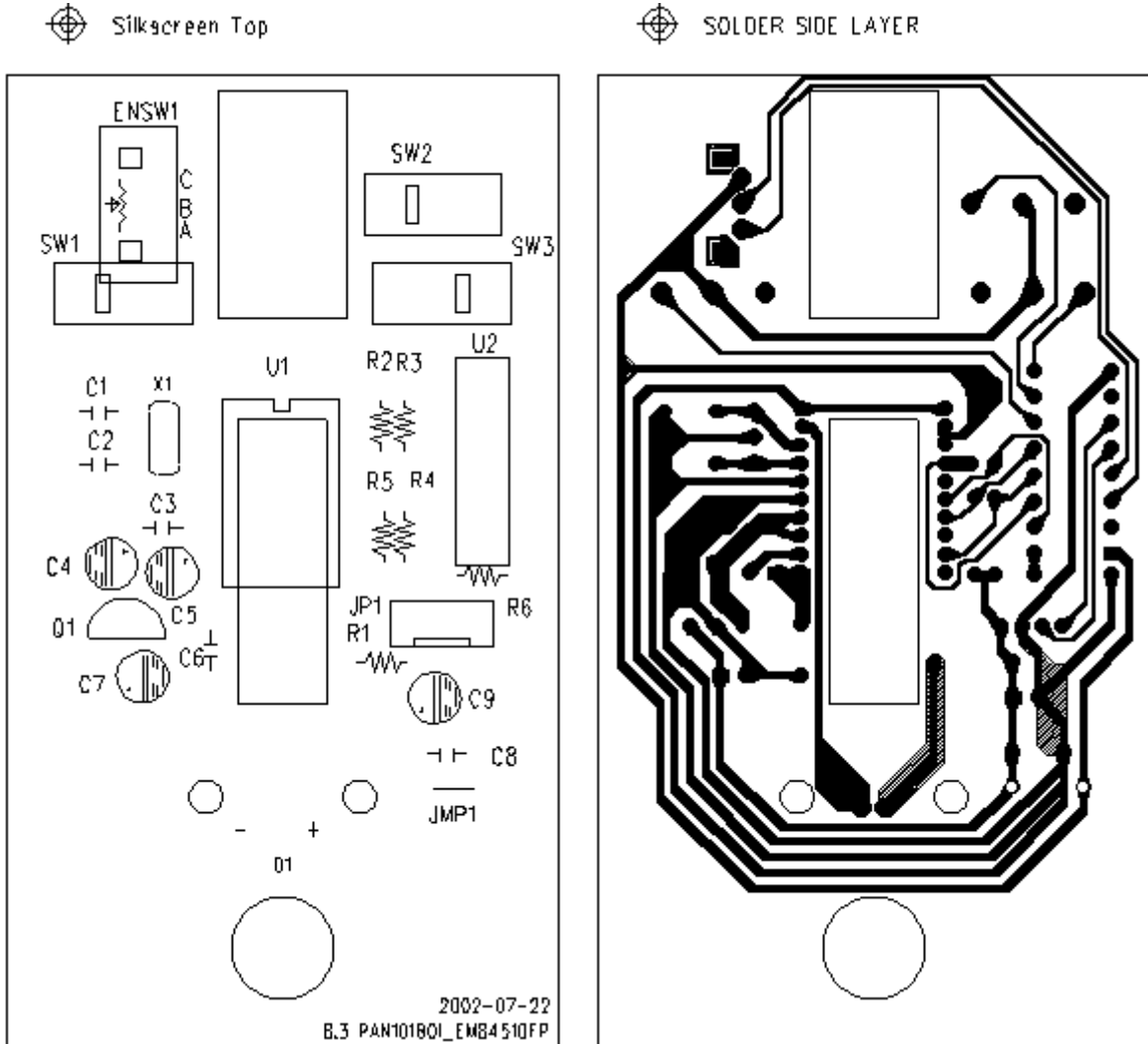

Figure 24. Example printed circuit board layout. (PAN101BOI V.S EM84510FP)

8.4 PCB layout consideration

1. Caps for pins 9, 10 **MUST** have trace lengths **LESS** than **5mm**.
2. The ground wires of pin1(VSS_LED), pin5(VSSD), pin6(VSSA) must be separated from PS2/USB connector ground node in PCB layout.
3. VSS_LED and VSSD must have trace lengths less than 100mm, VSSA must have trace lengths less than 80mm, and typical trace width is 30mil.
4. The trace lengths of OSCOUT, OSCIN must less than 6mm.

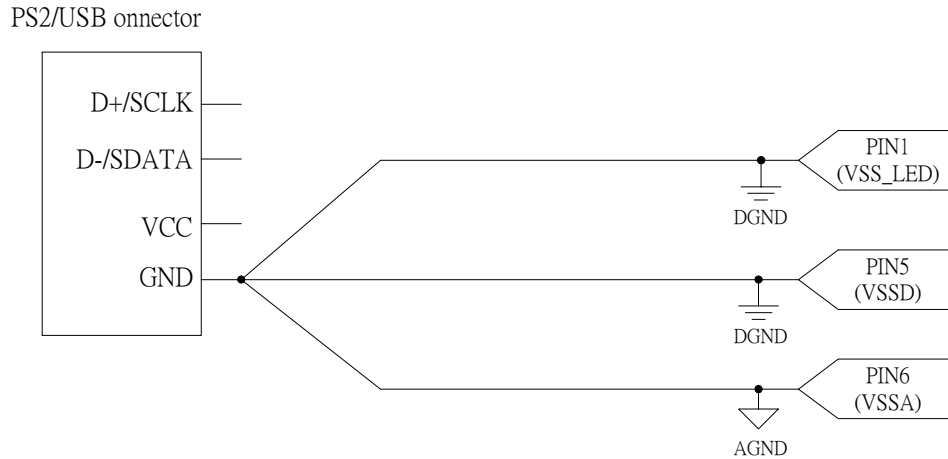

Figure 25. PCB layout consideration

8.5 Recommended value for R1

Radiometric intensity of LED
Bin limits (mW/Sr at 20mA)

Bin	Min	Max
N	14.7	17.7
P	17.7	21.2
Q	21.2	25.4
R	25.4	30.5
S	30.5	36.6
T	36.6	43.9

Note: Tolerance for each bin will be $\pm 15\%$

@5V:

LED bin	N	P	Q	R	S	T
R1 value (ohm)	100	100	100	120	120	120

Figure 26. Recommended value for R1

9. Package Information

9.1 Package Outline Drawing

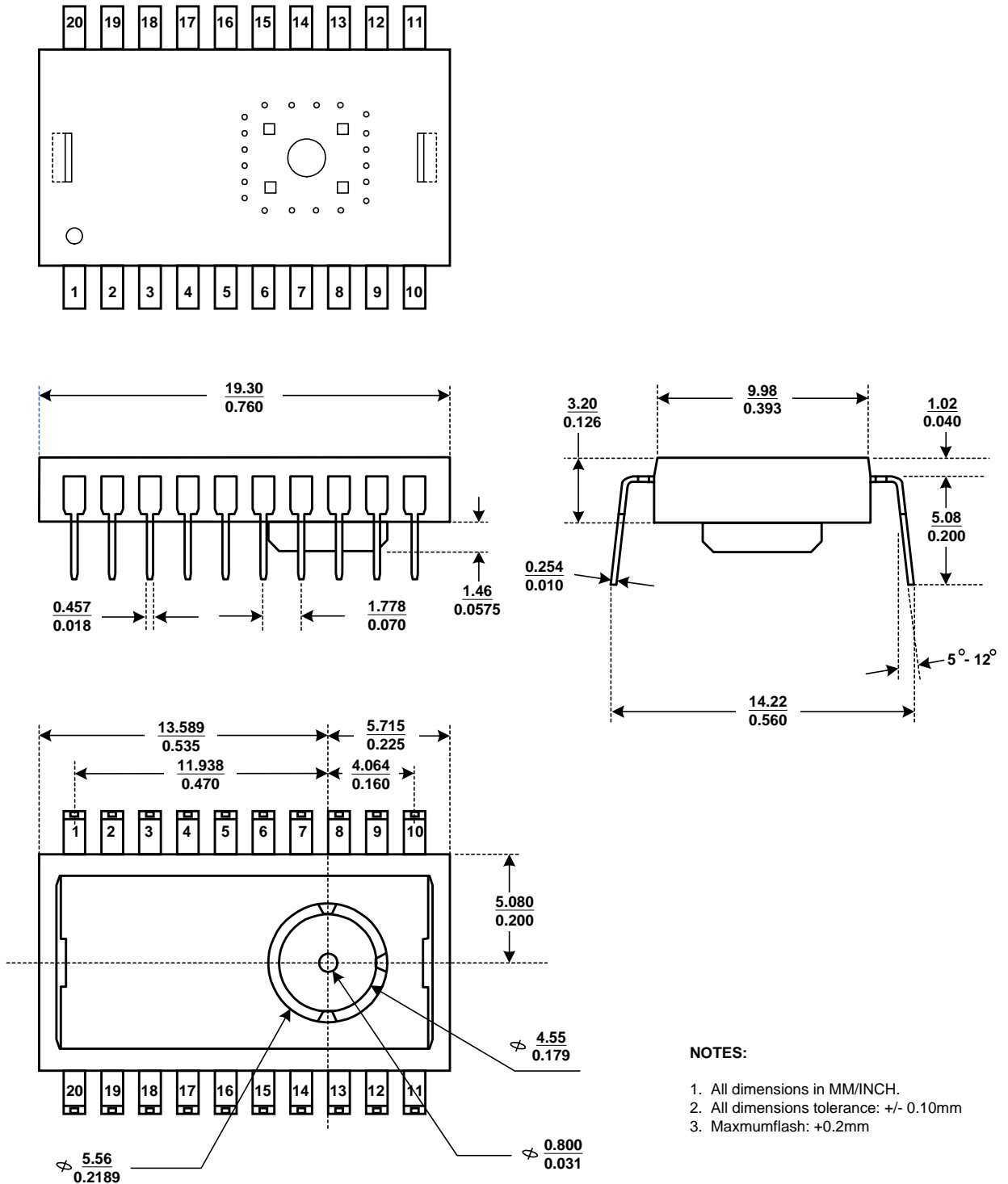

Figure 27. Package Outline Drawing

9.2 Recommended PCB Mechanical Cutouts and Spacing

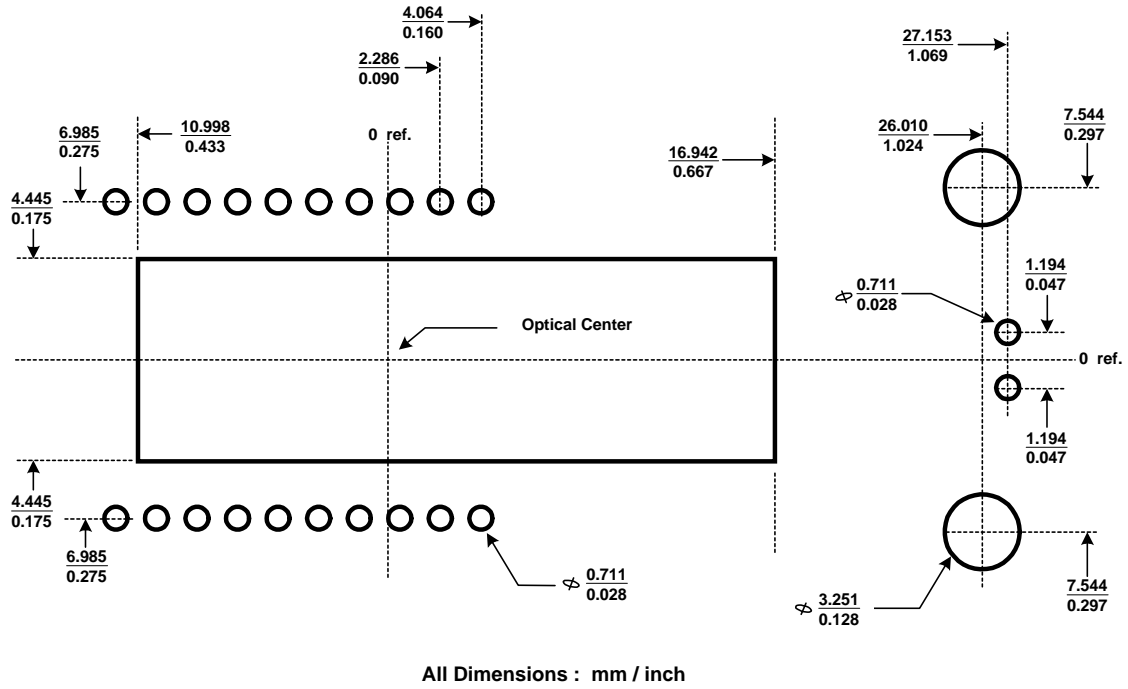

Figure 28. Recommended PCB Mechanical Cutouts and Spacing

10. Update history

Version	Update	Date
V1.0	Creation, 1 st version	07/02/2002
V1.1	8.4 PCB layout consideration Figure 27. Package Outline Drawing	08/29/2002
V1.2	4. Specifications - DC Electrical Characteristics Figure 27. Package Outline Drawing	10/02/2002
V1.3	3.2 Register descriptions 8.4 PCB layout consideration	10/14/2002
V1.4	Figure 25. PCB layout consideration Figure 27. Package Outline Drawing	02/10/2003