

1. Scope

The KSP-1MLR2, a silicon photodiode mounted in a TO-18 type header with black epoxy encapsulation, provides wide angular response and is relatively low-cost as compared to TO-18 can-type devices.

2. Features

- Wide angular response
- Low profile package
- Relatively low-cost against metal can package

3. Applications

- Optical detectors
- Infrared sensors
- Smoke detectors

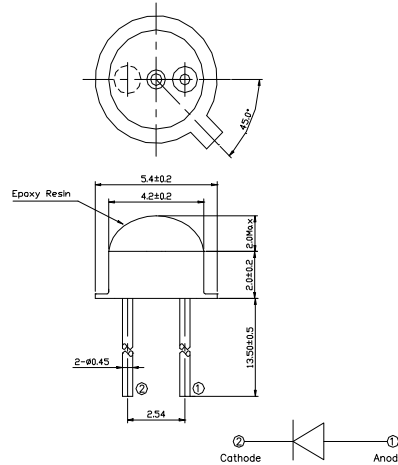

4. Package Outline

See the attached Drawing No. PD-KSP1MLR2-OT-01

5. Absolute Maximum Ratings

[Ta = 25]

Item	Symbol	Ratings	Unit
Reverse Voltage	V_R	20	V
Operating Temperature	$T_{opr.}$	-25 ~ +90	
Storage Temperature	$T_{stg.}$	-30 ~ +100	
Soldering Temperature	$T_{sol.}$	260	

6. Electro-optical Characteristics

[Ta = 25]

Item	Symbol	Condition	Min.	Typ.	Max.	Unit
Open circuit voltage	V_{oc}	$E_v=1,000lx$ *1		0.4		V
Short circuit current	I_{sc}		8	11		μA
Dark current	I_d	$V_R=5V$			0.1	μA
Capacitance	C_t			50		pF
Temperature coefficient of V_{oc}	t	$V=0V, f=1MHz$		-2.2		V
Temperature coefficient of I_{sc}	t			0.18		MHz
Spectral sensitivity			700~1,050			nm
Peak wavelength	p			900		nm
Half angle				± 60		deg.

*1. Color temp.=2856K standard Tungsten lamp

7. Typical Electrical-optical Characteristics Curves

Light current Vs. Forward voltage

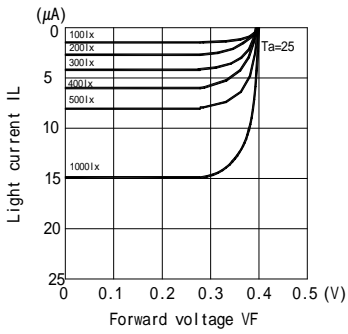

Short circuit current Vs. Illuminance

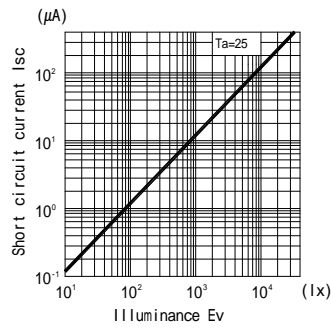

Dark current Vs. Ambient temperature

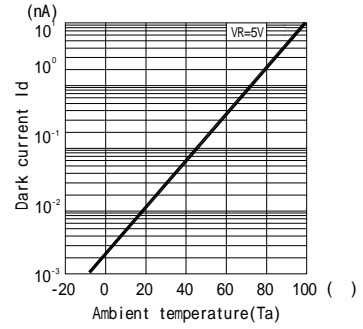

Relative sensitivity Vs. Wavelength

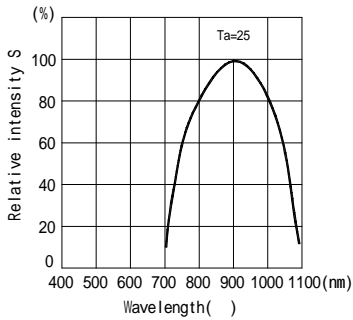

Dark current Vs. Reverse voltage

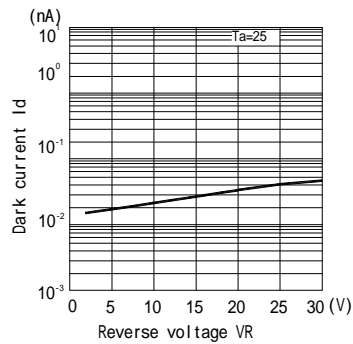

Radiant Pattern.

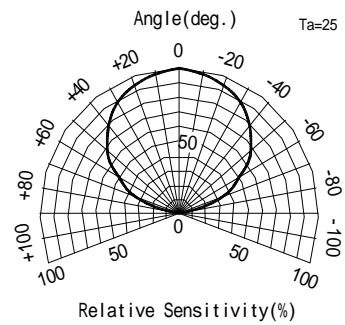

Capacitance between terminal Vs. Reverse voltage

