

High Dynamic Range LNA, 800 - 1000 MHz

AM50-0011
V6

Features

- Ideal for Base Station Applications
- High Gain: 17 dB @ 900 MHz
- Low Noise Figure: ≤ 1.0 dB @ 900 MHz
- Single Supply +5 VDC

Description

M/A-COM's AM50-0011 is a high dynamic range, GaAs MMIC, low noise amplifier in a low-cost SOT-26 package. It employs external matching to obtain optimum noise figure and intercept performance. The AM50-0011 may be operated with supply voltages of +5 V.

The AM50-0011 is ideally suited for use where low noise figure, high gain, and high dynamic range are required. Typical applications included receiver front ends in AMPS, GSM and ETACS base stations. It may also be used as an IF amplifier in certain other communication systems.

The AM50-0011 is fabricated using a low-cost 0.5-micron gate E-D SAGFET GaAs process. This process features full passivation for increased reliability. The AM50-0011 is 100% RF tested to ensure performance specification compliance.

Ordering Information

Part Number	Package
AM50-0011	Bulk Packaging
AM50-0011TR	1000 piece reel
AM50-0011TR-3000	3000 piece reel
AM50-0011SMB	Sample Test Board

Note: Reference Application Note M513 for reel size information.

Functional Block Diagram

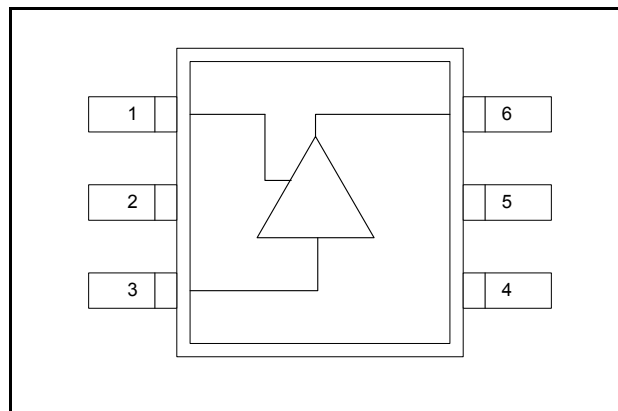

Pin Configuration

Pin No.	Function	Pin No.	Function
1	VB	4	GND
2	GND	5	GND
3	RF IN	6	RF OUT

Absolute Maximum Ratings ¹

Parameter	Absolute Maximum
Supply Voltage	6 V
RF input Power	8 dBm
Operating Temperature	-40°C to +85°C
Storage Temperature	-65°C to +150°C

1. Exceeding any one or combination of these limits may cause permanent damage to this device.

**High Dynamic Range LNA,
800 - 1000 MHz**

**AM50-0011
V6**

**Electrical Specifications: $T_A = 25^\circ\text{C}$, $Z_0 = 50\Omega$, $F = 900\text{ MHz}$, $\text{PIN} = -20\text{ dBm}$,
Supply Voltage = 5V^2**

Parameter	Test Conditions	Units	Min	Typ	Max
Gain	800 - 1000 MHz	dB	15.8	16.8	17.8
Noise Figure	800 - 1000 MHz	dB	—	0.95	1.3
Output P1 dB	800 - 1000 MHz	dBm	—	14	—
Input IP3	800 - 1000 MHz	dBm	—	13.5	—
Input VSWR	800 - 1000 MHz	—	—	1.5	—
Output VSWR	800 - 1000 MHz	—	—	1.7	—
Supply Current	800 - 1000 MHz	mA	—	40	60

2. All measurements are taken into a 50 Ohm system unless otherwise specified.

Application Schematic

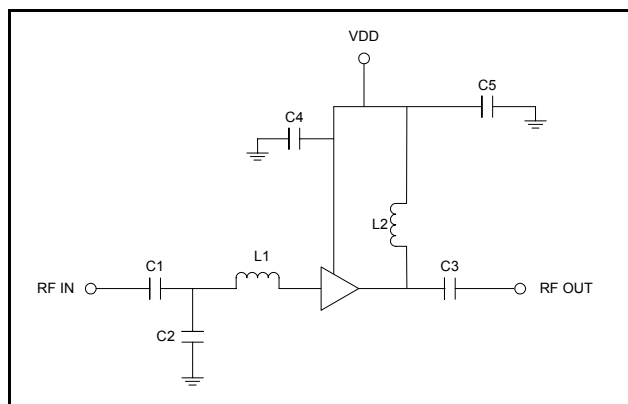

Component List

Part	Value	Case Size	Manufacturer
L1	6.8 nH	0402	Coilcraft
L2	68 nH	0402	Coilcraft
C1	1000 pF	0402	Murata
C2	3.9 pF	0402	Murata
C3	100 pF	0402	Murata
C4, C5	0.1 μF	0402	Murata

Handling Procedures

Please observe the following precautions to avoid damage:

Static Sensitivity

Gallium Arsenide Integrated Circuits are sensitive to electrostatic discharge (ESD) and can be damaged by static electricity. Proper ESD control techniques should be used when handling these devices.

SOT-26 Plastic Package

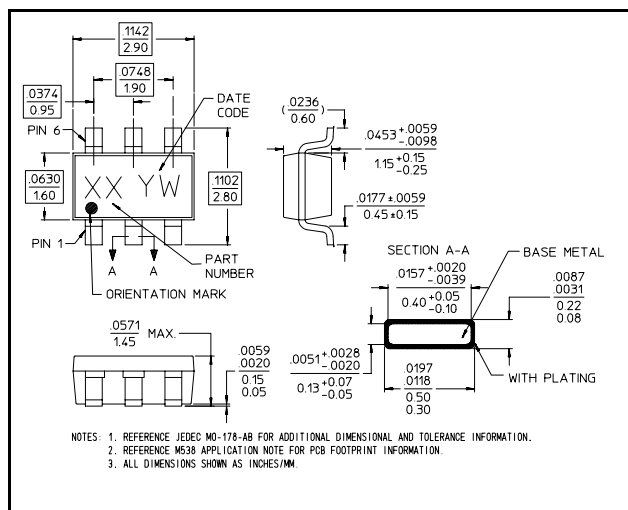

**High Dynamic Range LNA,
800 - 1000 MHz**

**AM50-0011
V6**

Typical Performance Curves

Gain vs. Frequency $P_{in} = -20$ dBm, $V_{dd} = 5.0$ Volts

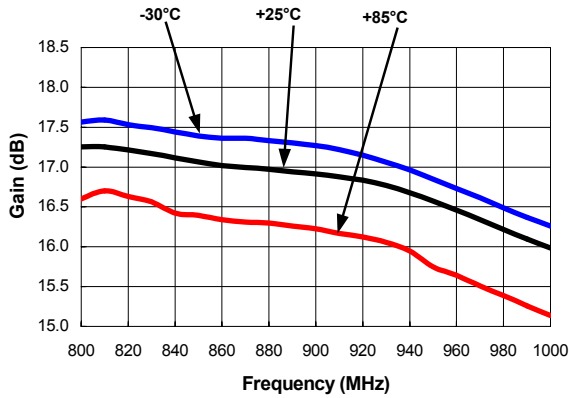

P1 dB vs. Frequency $V_{dd} = 5$ V

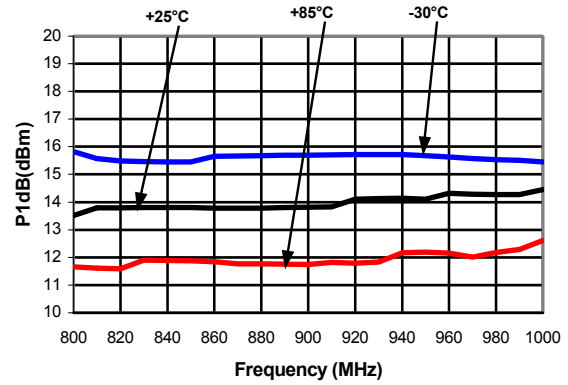

Input VSWR vs. Frequency

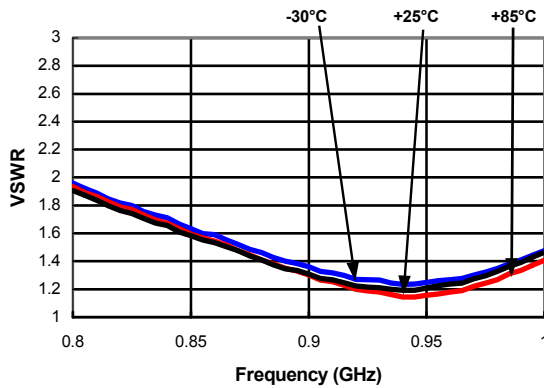

Output VSWR vs. Frequency

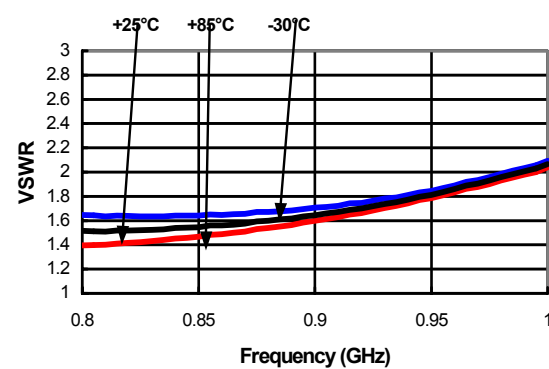

Noise Figure vs. Frequency

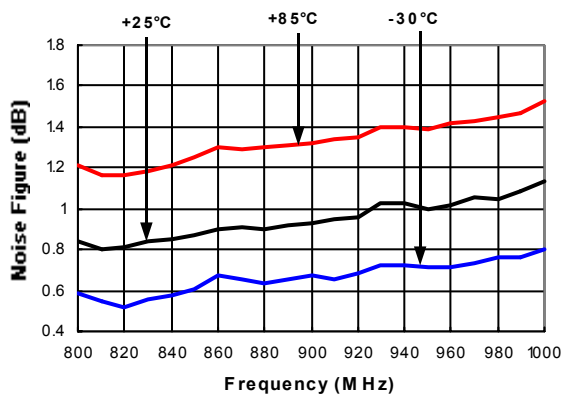

Input IP3 vs. Frequency, $P_{in} = 20$ dBm, $V_{dd} = 5$ Volts

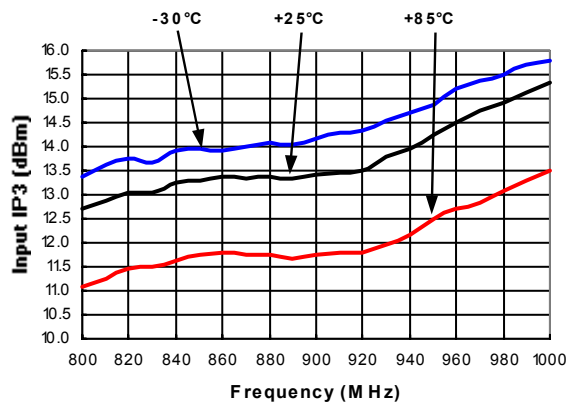

Typical Performance Curves

Current vs. Temperature

