

1.5A Low Dropout Regulator with Enable

Features

- Adjustable Output from 1.2V to 4.8V Using External Resistors
- 1.5V, 1.8V and 2.5V Options by Setting ADJ Pin Below 0.2V
- Over Current and Over Temperature Protection
- 500mV Dropout @1.5A
- Enable Pin
- 10µA Quiescent Current in Shutdown
- SOP-8 Package

Applications

- Battery Powered Systems
- Motherboards
- Peripheral Cards
- Network Cards
- Set Top Boxes
- Medical Equipment

■ Notebook Computers

General Description

The G965 is a high performance positive voltage regulator designed for use in applications requiring very low dropout voltage at up to 1.5 Amps. Since it has superior dropout characteristics compared to regular LDOs, it can be used to supply 2.5V on motherboards or 1.5V, 1.8V on peripheral cards from the 3.3V supply thus allowing the elimination of costly heatsinks. An enable pin further reduces power dissipation while shut down. The G965 provides excellent regulation over variations in line, load and temperature.

The SOP-8 is available with 1.5V, 1.8V and 2.5V internally preset outputs that are also adjustable using external resistors.

Ordering Information

ORDER NUMBER	ORDER NUMBER (Pb free)	MARKING	TEMP. RANGE	PACKAGE
G965-15ADJP1U	G965-15ADJP1Uf	G965-15	-40°C ~ +85°C	SOP-8
G965-18ADJP1U	G965-18ADJP1Uf	G965-18	-40°C ~ +85°C	SOP-8
G965-25ADJP1U	G965-25ADJP1Uf	G965-25	-40°C ~ +85°C	SOP-8

Note: P1: SOP-8

U : Tape & Reel

e.g. 18 denotes the 1.8V output voltage.

Pin Configuration

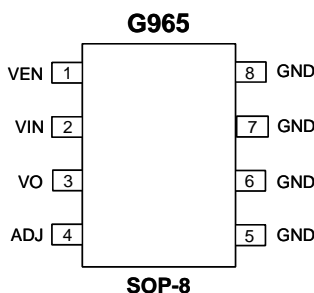

Typical Application Circuit

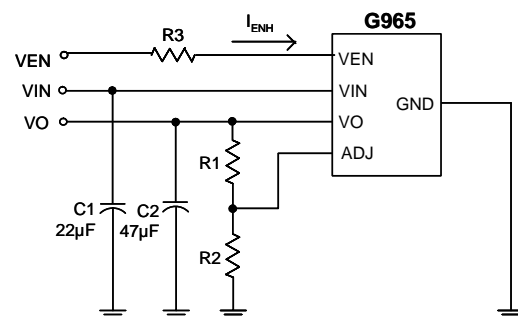

$$VO = \frac{1.2 (R1+R2)}{R2} \text{ Volts}$$

R2=12kΩ is recommended

R3 should be connected for current I_{ENH} restriction as $V_{EN} > V_{IN}+0.3V$

**Absolute Maximum Ratings** (Note 1)

Input Voltage.....	7V
V _{EN} Voltage.....	V _{IN} +0.3V
Power Dissipation Internally Limited	(Note 2)
Maximum Junction Temperature.....	150°C
Storage Temperature Range.....	-65°C ≤ T _J ≤ +150°C
Reflow Temperature (soldering, 10sec).....	260°C
Thermal Resistance Junction to Ambient, (θ _{JA})	
SOP-8.....	162°C/W
Thermal Resistance Junction to Case, (θ _{JC})	
SOP-8.....	31°C/W
ESD Rating (Human Body Model).....	2kV

Operation Conditions (Note 1)

Input Voltage.....	2.2V ~5.5V
Temperature Range.....	-40°C ≤ T _A ≤ +85°C

Electrical Characteristics

V_{EN}=V_{IN}, V_{IN}=5V, I_O=0.5A, C_{IN}=4.7μF, C_{OUT}=10μF, T_A=T_J=25°C unless otherwise specified (Note 3)

PARAMETER	SYMBOL	CONDITION	MIN	TYP	MAX	UNIT
Supply Voltage	V _{IN}		2.2	---	5.5	V
Output Voltage	V _O	V _{IN} =V _O +0.7V, I _O =10mA	-2	V _O	2	%
Line Regulation		V _O +0.7V ≤ V _{IN} ≤ 5.5V, I _O =10mA	---	0.2	2	%
Load Regulation		10mA ≤ I _O ≤ 1.5A	---	0.8	2	%
Quiescent Current	I _Q	V _{IN} =3.3V, V _{EN} =V _{IN}	---	1.7	2.5	mA
		V _{IN} =3.3V, V _{EN} =0V	---	16	35	μA
Ripple Rejection		f _i =120Hz, 1V _{P-P} , I _O =100mA	---	55	---	dB
Dropout Voltage	V _D	I _O =1.5A	---	0.5	0.65	V
Short Circuit Current			---	0.8	---	A
Over Temperature			---	150	---	°C
V _{EN} Voltage High	V _{ENH}	Output Active	1.6	---	---	V
V _{EN} Voltage Low	V _{ENL}	Output Disabled	---	---	0.4	V
V _{EN} Bias Current Low	I _{ENL}	V _{EN} =0.4V	---	---	20	μA
ADJ Reference Voltage	V _{REF}	V _{IN} =2.2V, V _{ADJ} =V _{OUT} , I _O =10mA	1.188	1.2	1.212	V
ADJ Pin Threshold			---	0.2	---	V

Note 1: Absolute Maximum Ratings are limits beyond which damage to the device may occur. Operating Conditions are conditions under which the device functions but the specifications might not be guaranteed. For guaranteed specifications and test conditions see the Electrical Characteristics.

Note2: The maximum power dissipation is a function of the maximum junction temperature, T_{Jmax}; total thermal resistance, θ_{JA}, and ambient temperature T_A. The maximum allowable power dissipation at any ambient temperature is (T_{Jmax}-T_A)/θ_{JA}. If this dissipation is exceeded, the die temperature will rise above 150°C and IC will go into thermal shutdown.

Note3: Low duty pulse techniques are used during test to maintain junction temperature as close to ambient as possible.

Note4: The type of output capacitor should be tantalum or aluminum.

Definitions**Dropout Voltage**

The input/output Voltage differential at which the regulator output no longer maintains regulation against further reductions in input voltage. Measured when the output drops 2% below its nominal value, dropout voltage is affected by junction temperature, load current and minimum input supply requirements.

Line Regulation

The change in output voltage for a change in input voltage. The measurement is made under conditions of low dissipation or by using pulse techniques such that average chip temperature is not significantly affected.

Load Regulation

The change in output voltage for a change in load current at constant chip temperature. The measurement is made under conditions of low dissipation or by using pulse techniques such that average chip temperature is not significantly affected.

Maximum Power Dissipation

The maximum total device dissipation for which the regulator will operate within specifications.

Quiescent Bias Current

Current which is used to operate the regulator chip and is not delivered to the load.

Typical Performance Characteristics

$V_{EN}=V_{IN}$, $V_{IN}=5V$, $I_O=0.5A$, $C_{IN}=4.7\mu F$, $C_{OUT}=10\mu F$, $T_A=T_J=25^\circ C$

Line Transient(G965-15)

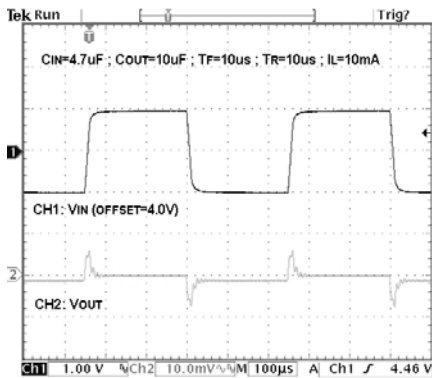

Load Transient(G965-15)

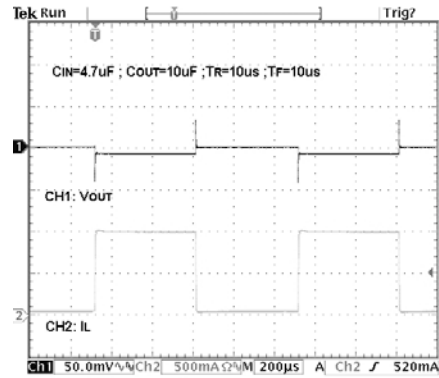

Line Transient Response(G965-18)

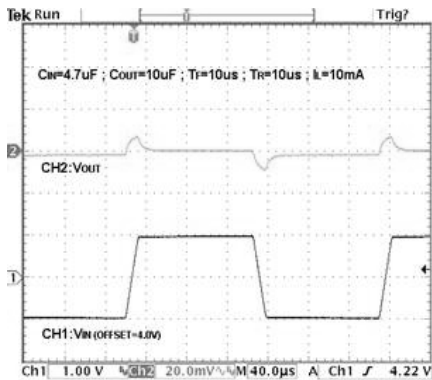

Load Transient Response(G965-18)

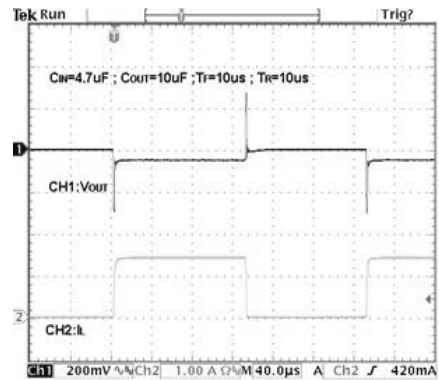

Line Transient Response(G965-25)

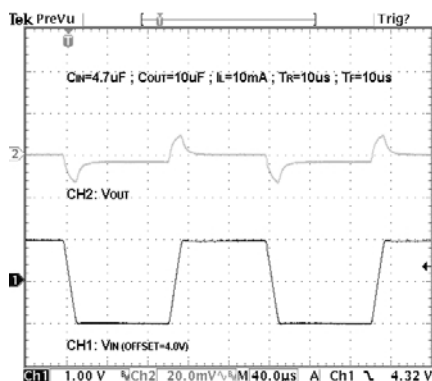

Load Transient Response(G965-25)

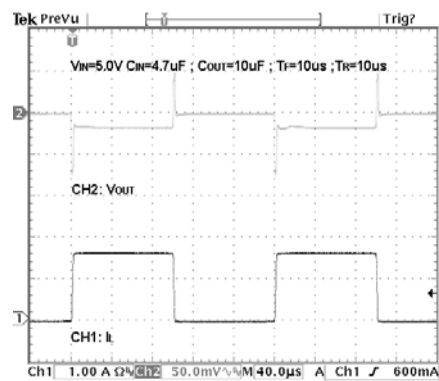

Typical Performance Characteristics (continued)

Start-UP(G965-15)

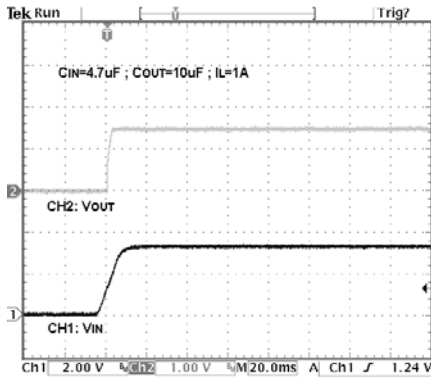

Overcurrent Protection Characteristics(G965-15)

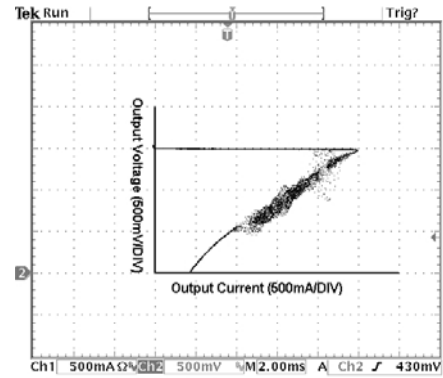

Start-up(G965-18)

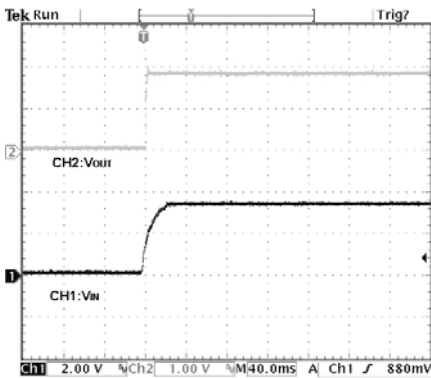

Overcurrent Protection Characteristics(G965-18)

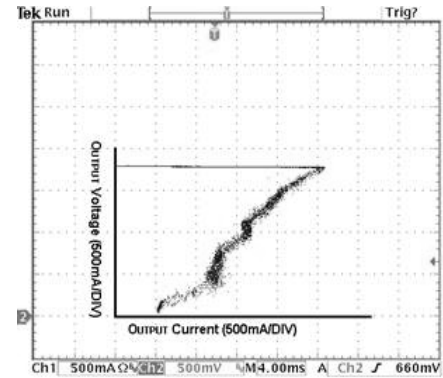

Start-up(G965-25)

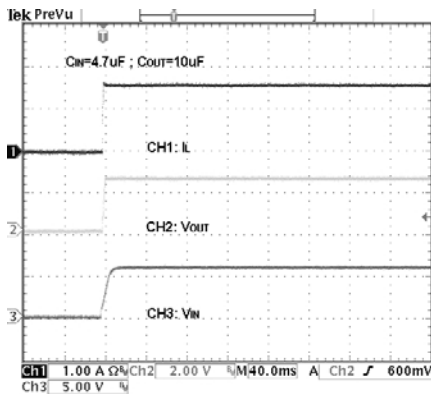

Overcurrent Protection Characteristics(G965-25)

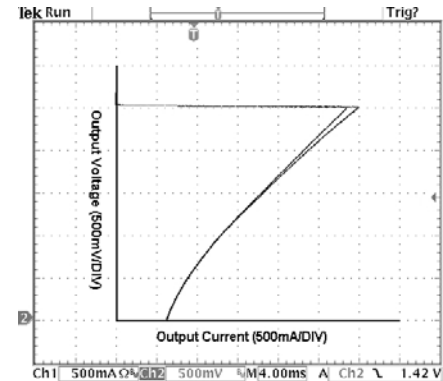

Typical Performance Characteristics (continued)

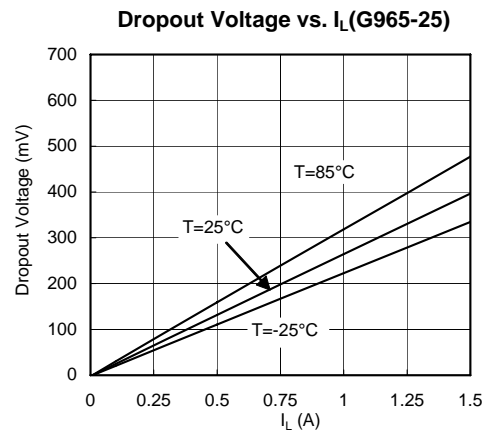
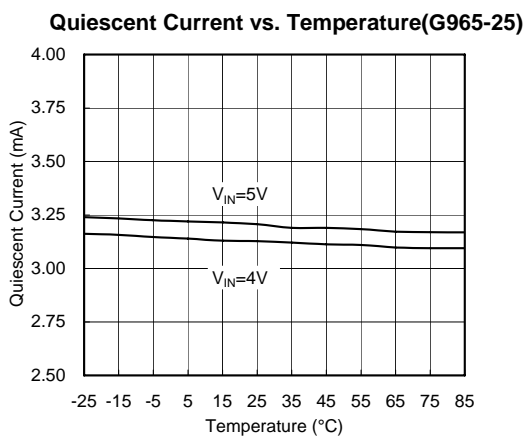
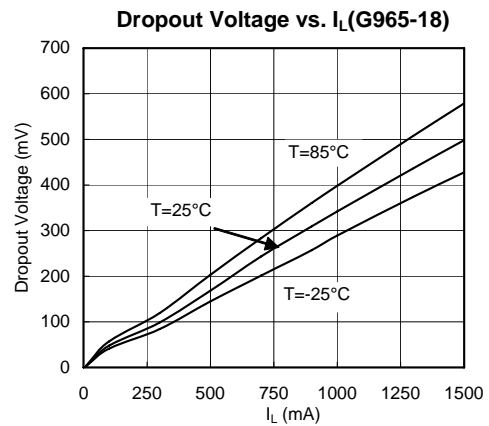
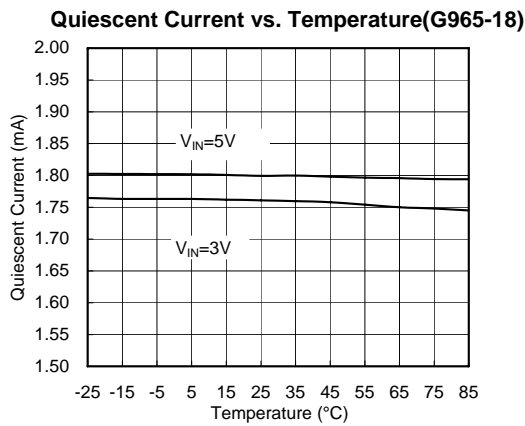
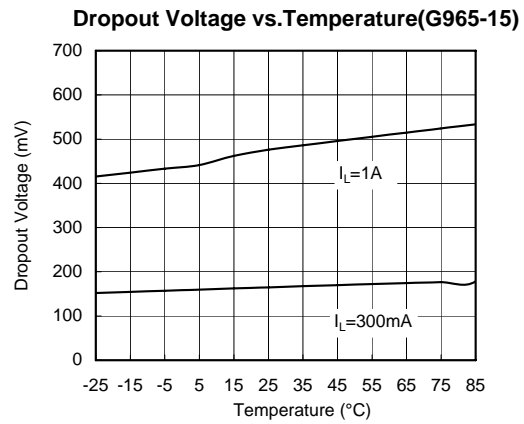
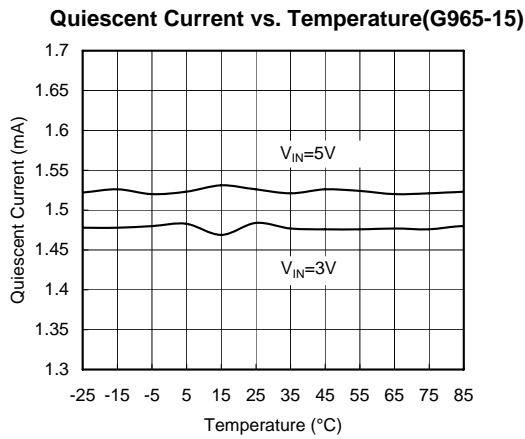

Typical Performance Characteristics (continued)

Output Voltage vs. Temperature(G965-15)

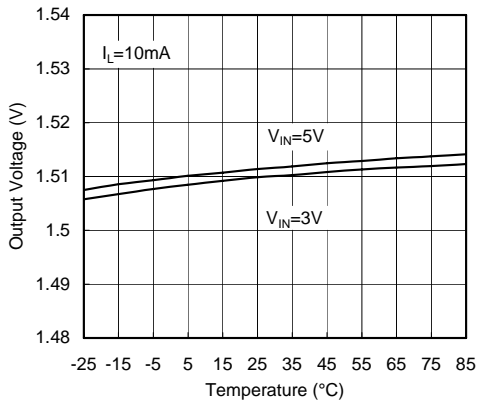

Output Voltage vs. VIN(G965-15)

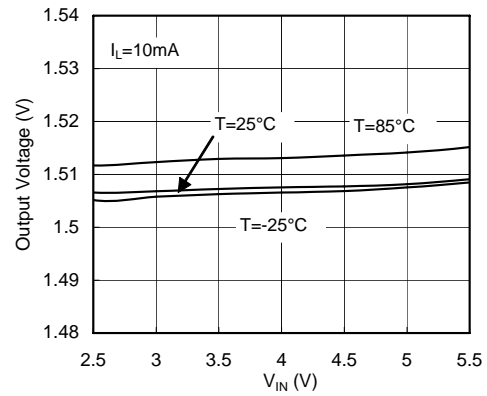

Output Voltage vs. Temperature(G965-18)

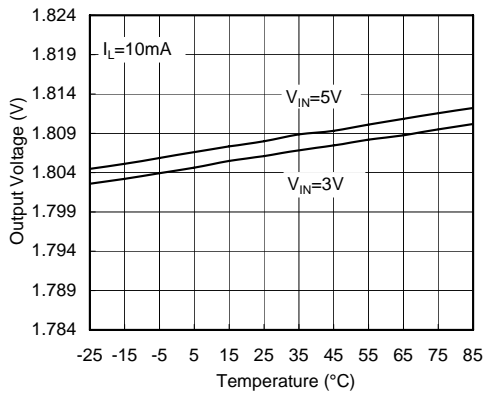

Output Voltage vs. VIN(G965-18)

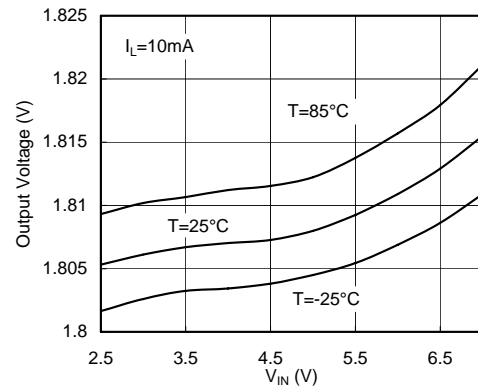

Output Voltage vs. Temperature(G965-25)

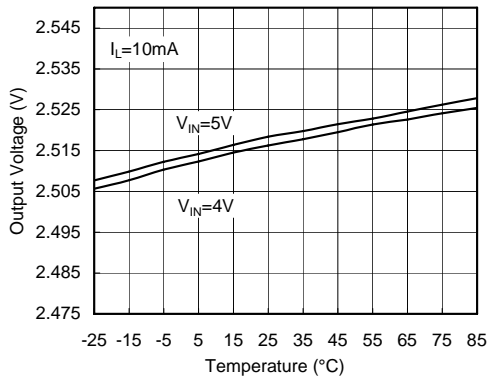

Output Voltage vs. VIN(G965-25)

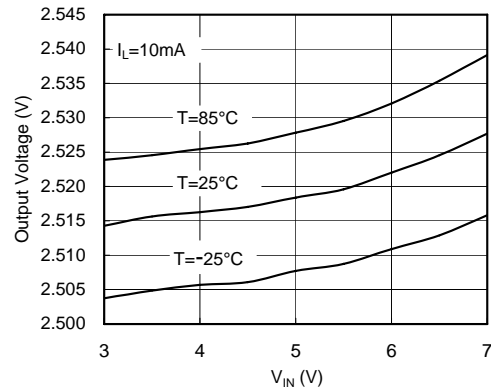

Typical Performance Characteristics (continued)

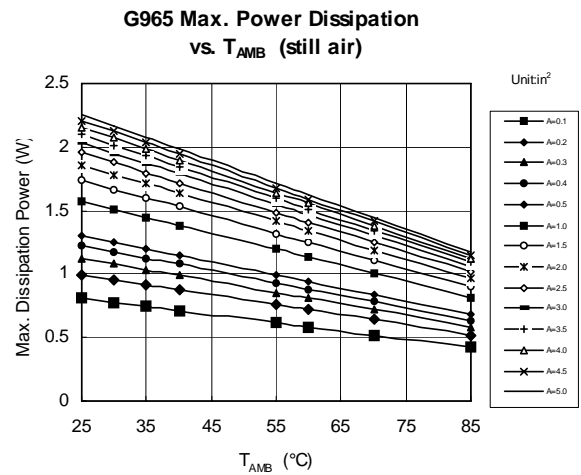
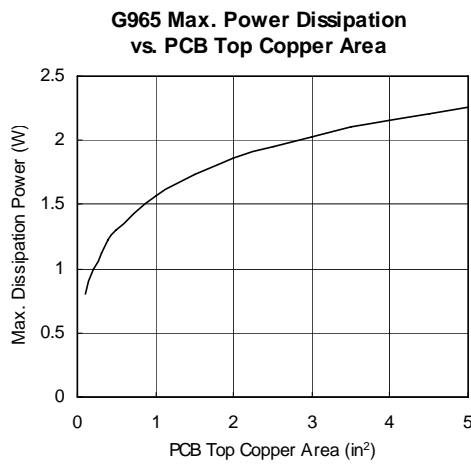
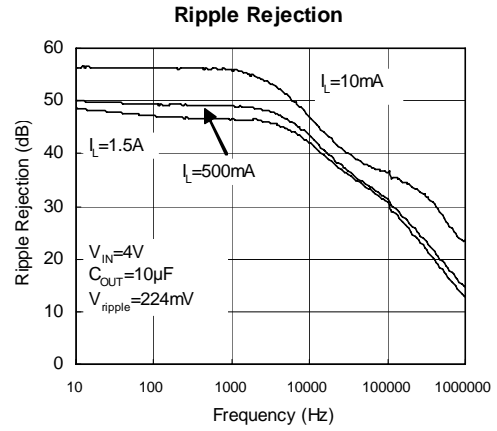
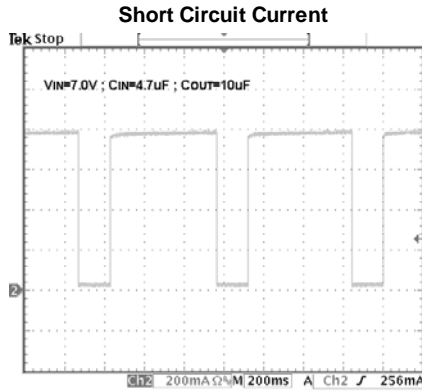

Recommended Minimum Footprint

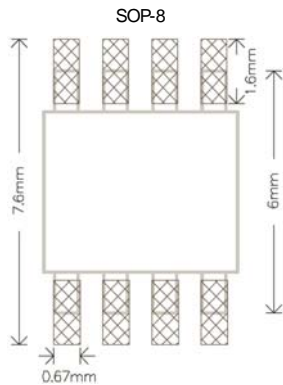

Package Information

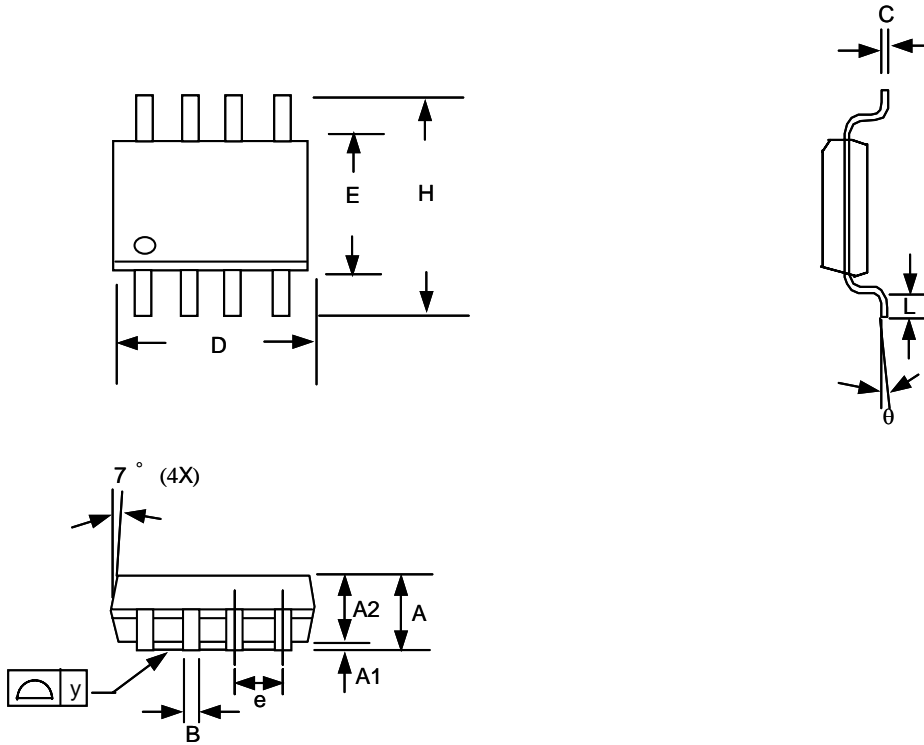

SOP-8 Package

Note:

1. Package body sizes exclude mold flash and gate burrs
2. Dimension L is measured in gage plane
3. Tolerance 0.10mm unless otherwise specified
4. Controlling dimension is millimeter converted inch dimensions are not necessarily exact.

SYMBOL	DIMENSION IN MM			DIMENSION IN INCH		
	MIN	NOM	MAX	MIN	NOM	MAX
A	1.45	1.60	1.75	0.057	0.063	0.069
A1	0.10	-----	0.25	0.004	-----	0.010
A2	1.35	1.45	1.55	0.053	0.057	0.061
B	0.306	-----	0.506	0.012	-----	0.020
C	0.153	-----	0.253	0.006	-----	0.010
D	4.81	-----	5.01	0.189	-----	0.197
E	3.84	-----	4.04	0.151	-----	0.159
e	-----	1.27	-----	-----	0.050	-----
H	5.84	-----	6.24	0.230	-----	0.246
L	0.45	-----	1.00	0.018	-----	0.039
θ	0°	-----	8°	0°	-----	8°

Taping Specification

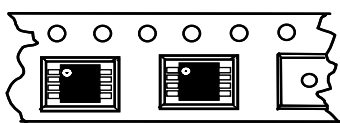

Typical SOP Package Orientation

PACKAGE	Q'TY/REEL
SOP-8	2,500 ea

GMT Inc. does not assume any responsibility for use of any circuitry described, no circuit patent licenses are implied and GMT Inc. reserves the right at any time without notice to change said circuitry and specifications.