

**FEATURES**

- DTL/TTL/CMOS Direct Interface
- Power Dissipation: 30 $\mu$ W
- R<sub>ON</sub>: 170 $\Omega$
- Output "Enable" Control
- AD7503 Replaces HI-1818

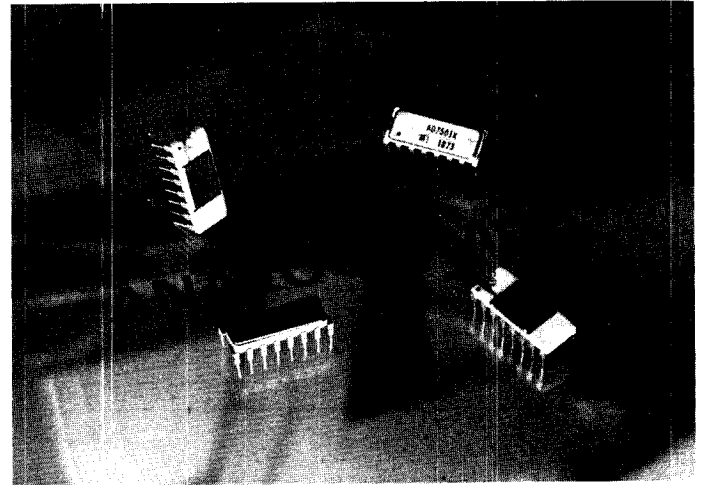

**GENERAL DESCRIPTION**

The AD7501 and AD7503 are monolithic CMOS, 8 channel analog multiplexers which switches one of 8 inputs to a common output depending on the state of three binary address lines and an "enable" input. The AD7503 is identical to the AD7501 except its "enable" logic is inverted. All digital inputs are TTL/DTL and CMOS logic compatible.

The AD7502 is a monolithic CMOS dual 4-channel analog multiplexer. Depending on the state of 2 binary address inputs and an "enable", it switches two output busses to two of 8 inputs.

The AD7502 is an excellent example of a high breakdown CMOS process combined with a double layer interconnect for high density. Silicon nitride passivation ensures long term stability and reliability.

**FUNCTIONAL DIAGRAMS**

AD7501, AD7503

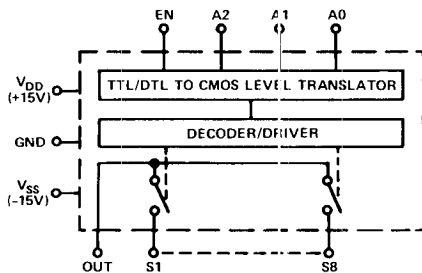

AD7502

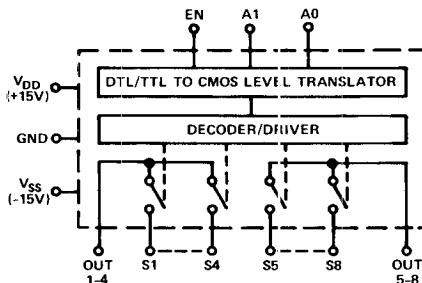

**ABSOLUTE MAXIMUM RATINGS**

(T<sub>A</sub> = +25°C unless otherwise noted)

V <sub>DD</sub> - GND	.....	+17V
V <sub>SS</sub> - GND	.....	-17V
V Between Any Switch Terminals	.....	25V
Switch Current (I <sub>S</sub> , Continuous)	.....	35mA
Switch Current (I <sub>S</sub> , Surge)	.....	50mA
1ms duration, 10% duty cycle	.....	50mA
Digital Input Voltage Range	.....	V <sub>DD</sub> to GND
Power Dissipation (package)		
16 pin Ceramic DIP		
Up to +75°C	.....	450mW
Derates above +75°C by	.....	6mW/°C
16 pin Plastic DIP		
Up to +70°C	.....	670mW
Derates above +70°C by	.....	8.3mW/°C
Operating Temperature		
Plastic	.....	0 to +75°C
Ceramic (J, K versions)	.....	-25°C to +85°C
Ceramic (S version)	.....	-55°C to +125°C
Storage Temperature	.....	-65°C to +150°C

**CAUTION:**

1. Do not apply voltages higher than V<sub>DD</sub> and V<sub>SS</sub> to any other terminal, especially when V<sub>SS</sub> = V<sub>DD</sub> = 0V all other pins should be at 0V.
2. The digital control inputs are zener protected; however, permanent damage may occur on unconnected units under high energy electrostatic fields. Keep unused units in conductive foam at all times.

**PIN CONFIGURATIONS (Top View)**

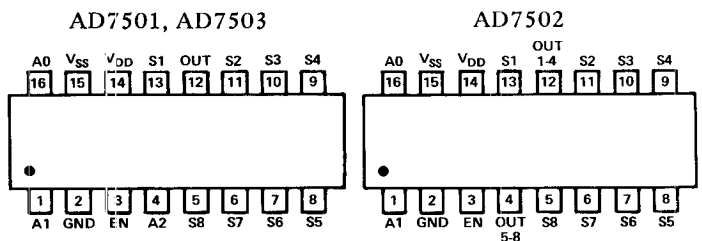

# SPECIFICATIONS

( $V_{DD} = +15V$ ,  $V_{SS} = -15V$  unless otherwise noted)

PARAMETER	VERSION <sup>1</sup>	SWITCH CONDITION	@25°C		OVER SPECIFIED TEMP. RANGE		TEST CONDITIONS
			AD7501, AD7503	AD7502	AD7501, AD7503	AD7502	
<b>ANALOG SWITCH</b>							
$R_{ON}$	All	ON	170Ω typ, 300Ω max	*			$-10V \leq V_S \leq +10V$ $I_S = 1.0mA$
$R_{ON}$ vs. $V_S$	All	ON	20% typ	*			
$R_{ON}$ vs. Temperature	All	ON	0.5%/°C typ	*			$V_S = 0V$ , $I_S = 1.0mA$
$\Delta R_{ON}$ Between Switches	All	ON	4% typ	*			
$R_{ON}$ vs. Temperature Between Switches	All	ON	±0.01%/°C	*			
$I_S$	J, K S	OFF OFF	0.2nA typ, 2nA max 0.5nA max	* *	50nA max 50nA max	* *	$V_S = -10V$ , $V_{OUT} = +10V$ and $V_S = +10V$ , $V_{OUT} = -10V$
$I_{OUT}$	J, K S	OFF OFF	1nA typ, 10nA max 5nA max	0.6nA typ, 5nA max 3nA max	250nA max 250nA max	125nA max 125nA max	$V_S = -10V$ , $V_{OUT} = +10V$ and $V_S = +10V$ , $V_{OUT} = -10V$ AD7501: Enable HIGH AD7502, 03: Enable LOW
$ I_{OUT} - I_S $	J, K S	ON ON	12nA max 5.5nA max	7nA max 3.5nA max	300nA max 300nA max	175nA max 175nA max	$V_S = 0$
<b>DIGITAL CONTROL</b>							
$V_{INL}$	All				0.8V max	*	
$V_{INH}$	J K, S				3.0V min 2.4V min	* *	Note 2
$I_{INL}$ or $I_{INH}$	All		10nA typ	*			
$C_{IN}$	All		3pF typ	*			
<b>DYNAMIC CHARACTERISTICS<sup>3</sup></b>							
$t_{ON}$	All		0.8μs typ	*			$V_{IN} = 0$ to $+5.0V$ (See Test Circuit 2)
$t_{OFF}$	All		0.8μs typ	*			
$C_S$	All	OFF	5pF typ	*			
$C_{OUT}$	All	OFF	30pF typ	15pF typ			
$C_{S-OUT}$	All	OFF	0.5pF typ	*			
$C_{SS}$ Between Any Two Switches	All	OFF	0.5pF typ	*			
<b>POWER SUPPLY</b>							
$I_{DD}$	J, K		1μA typ, 100μA max	*			All Digital Inputs Low
$I_{SS}$	J, K		1μA typ, 100μA max	*			
$I_{DD}$	S		500μA max	*	500μA max	*	
$I_{SS}$	S		500μA max	*	500μA max	*	
$I_{DD}$	J, K		200μA typ, 500μA max	*			All Digital Inputs High
$I_{SS}$	J, K		1μA typ, 100μA max	*			
$I_{DD}$	S		800μA max	*	800μA max	*	
$I_{SS}$	S		800μA max	*	800μA max	*	

**NOTES:**

\*Same specifications as AD7501 and AD7503.

<sup>1</sup>JN, KN versions specified for 0 to +75°C; JD, KD versions for -25°C to +85°C; and SD versions for -55°C to +125°C.

<sup>2</sup>A pullup resistor, typically 1-2kΩ is required to make the AD7501J, AD7502J and AD7503J compatible with TTL/DTL levels. The maximum value is determined by the output leakage current of the driver gate when in the high state.

<sup>3</sup>AC parameters are sample tested to ensure conformance to specifications.

Specifications subject to change without notice.

## TRUTH TABLES

A <sub>2</sub>	A <sub>1</sub>	A <sub>0</sub>	E <sub>N</sub>	"ON"
0	0	0	1	1
0	0	1	1	2
0	1	0	1	3
0	1	1	1	4
1	0	0	1	5
1	0	1	1	6
1	1	0	1	7
1	1	1	1	8
X	X	X	0	None

A <sub>2</sub>	A <sub>1</sub>	A <sub>0</sub>	E <sub>N</sub>	"ON"
0	0	0	0	1
0	0	1	0	2
0	1	0	0	3
0	1	1	0	4
1	0	0	0	5
1	0	1	0	6
1	1	0	0	7
1	1	1	0	8
X	X	X	1	None

A <sub>1</sub>	A <sub>0</sub>	E <sub>N</sub>	"ON"
0	0	1	1 & 5
0	1	1	2 & 6
1	0	1	3 & 7
1	1	1	4 & 8
X	X	0	None

## ORDERING INFORMATION

Plastic (Suffix N)	Ceramic (Suffix D)	Operating Temperature Range
AD7501JN AD7501KN AD7503JN AD7503KN		0 to +75°C
	AD7501JD AD7501KD AD7503JD AD7503KD	-25°C to +85°C
	AD7501SD AD7503SD	-55°C to +125°C
AD7502JN AD7502KN		0 to +75°C
	AD7502JD AD7502KD	-25°C to +85°C
	AD7502SD	-55°C to +125°C

## 1. $R_{ON}$ As A Function Of Switch Voltage ( $V_S$ )

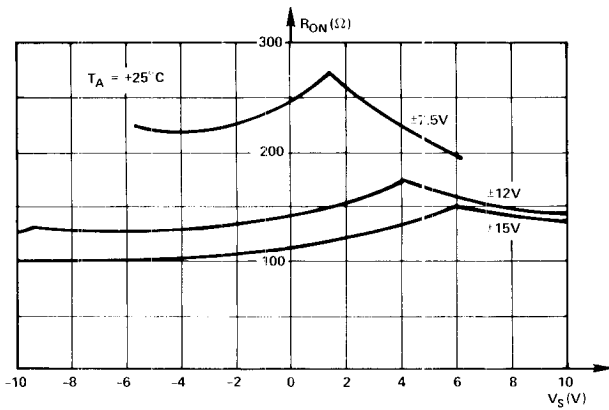

At Different Power Supplies

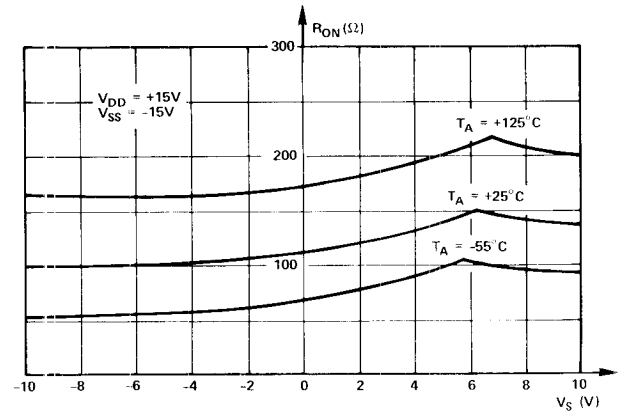

At Different Temperatures

## 2. Digital Threshold Voltage ( $V_{INH}$ , $V_{INL}$ )

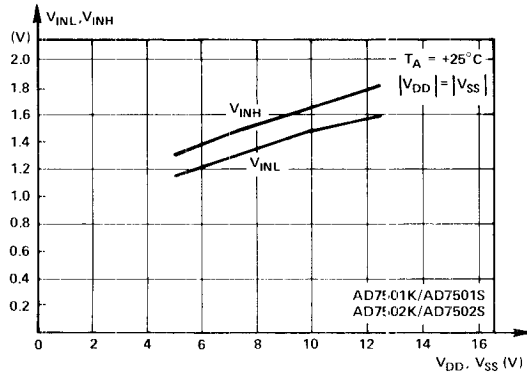

vs. Power Supply

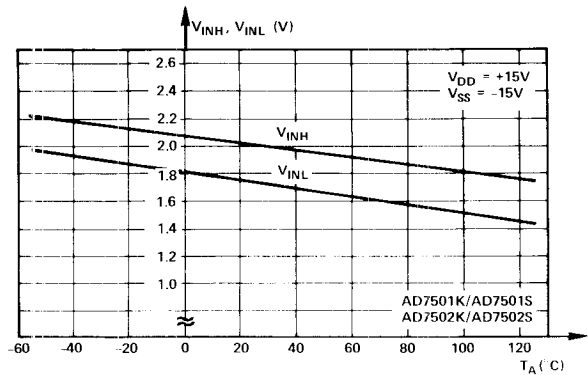

vs. Temperature

## 3. $t_{ON}$ , $t_{OFF}$

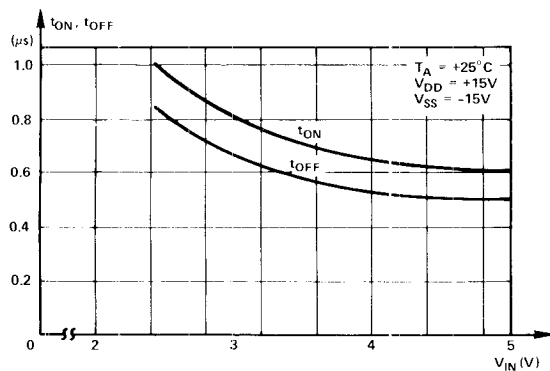

vs. Digital Input Voltage

## 4. Power Dissipation

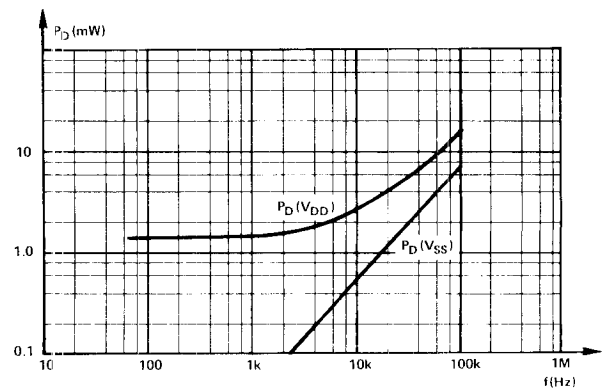

vs. Logic Frequency (50% Duty Cycle)

# TYPICAL SWITCHING CHARACTERISTICS

## TEST CIRCUIT 1

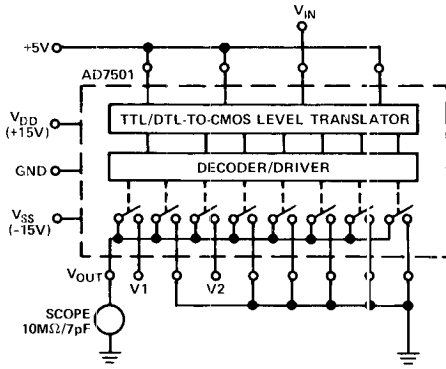

1μs/DIV

1μs/DIV

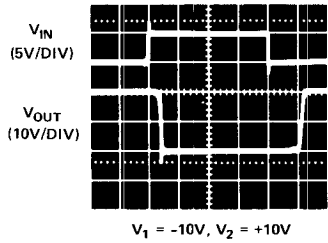

V<sub>1</sub> = -10V, V<sub>2</sub> = +10V

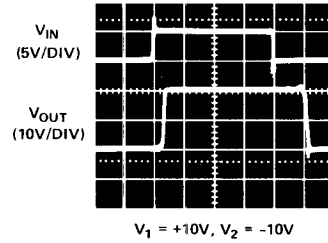

V<sub>1</sub> = +10V, V<sub>2</sub> = -10V

## TEST CIRCUIT 2

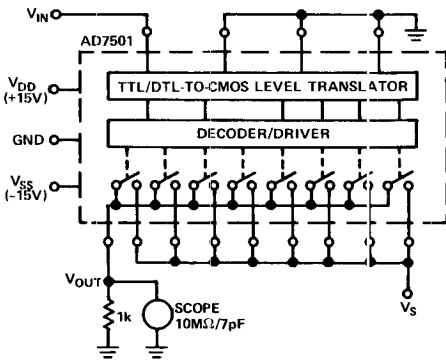

1μs/DIV

1μs/DIV

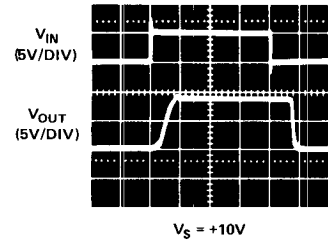

V<sub>S</sub> = +10V

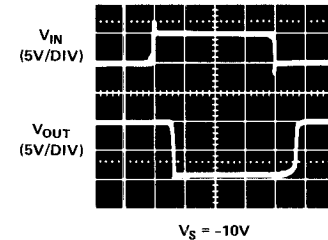

V<sub>S</sub> = -10V

1μs/DIV

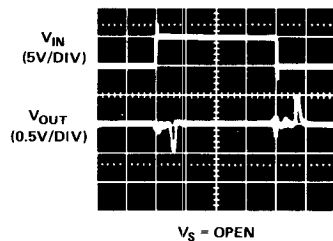

V<sub>S</sub> = OPEN

## OUTLINE DIMENSIONS

Dimensions shown in inches and (mm).

### 16-PIN CERAMIC DIP (SUFFIX D)

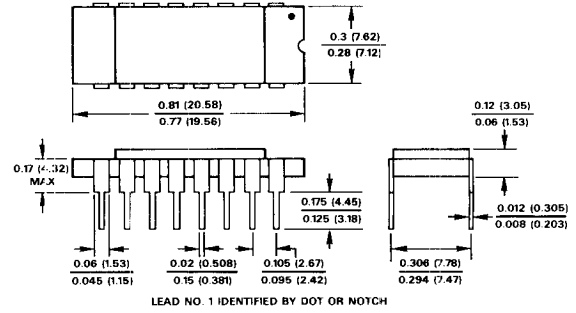

LEAD NO. 1 IDENTIFIED BY DOT OR NOTCH

### 16-PIN PLASTIC DIP (SUFFIX N)

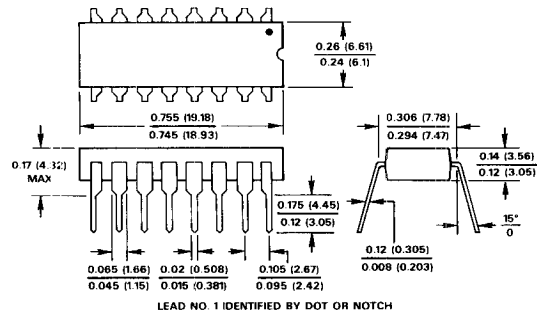

LEAD NO. 1 IDENTIFIED BY DOT OR NOTCH

## BONDING DIAGRAMS

AD7501

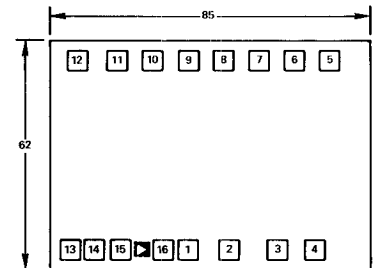

AD7502

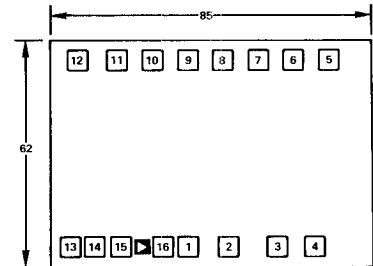

AD7503

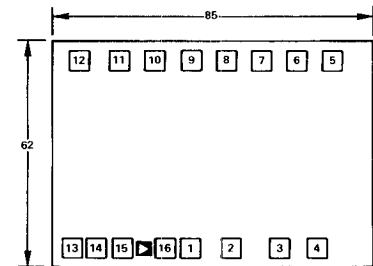

All bonding pads are 4 x 4 MIL.  
All pad numbers correspond with DIP package pin configuration.