

### FEATURES

Operates from 1.65 V to 3.6 V Supply Rails  
 Bidirectional Level Translation, Unidirectional Signal Path  
 8-Lead SOT-23 and MSOP Packages  
 Bypass or Normal Operation  
 Short Circuit Protection

### APPLICATIONS

JTAG Chain Bypassing  
 Daisy-Chain Bypassing  
 Digital Switching

### FUNCTIONAL BLOCK DIAGRAM

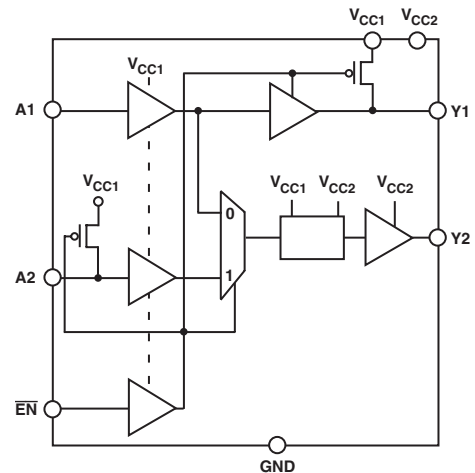

### GENERAL DESCRIPTION

The ADG3233 is a bypass switch designed on a submicron process that operates from supplies as low as 1.65 V. The device is guaranteed for operation over the supply range 1.65 V to 3.6 V. It operates from two supply voltages, allowing bidirectional level translation, i.e., it translates low voltages to higher voltages and vice versa. The signal path is unidirectional, meaning data may only flow from A to Y.

This type of device may be used in applications that require a bypassing function. It is ideally suited to bypassing devices in a JTAG chain or in a daisy-chain loop. One switch could be used for each device or a number of devices, thus allowing easy bypassing of one or more devices in a chain. This may be particularly useful in reducing the time overhead in testing devices in the JTAG chain or in daisy-chain applications where the user does not wish to change the settings of a particular device.

The bypass switch is packaged in two of the smallest footprints available for its required pin count. The 8-lead SOT-23 package requires only 8.26 mm × 8.26 mm board space, while the MSOP package occupies approximately 15 mm × 15 mm board area.

### PRODUCT HIGHLIGHTS

1. Bidirectional level translation matches any voltage level from 1.65 V to 3.6 V.
2. The bypass switch offers high performance and is fully guaranteed across the supply range.
3. Short circuit protection.
4. Tiny 8-lead SOT-23 package, 8.26 mm × 8.26 mm board area, or 8-lead MSOP.

Table I. Truth Table

$\overline{\text{EN}}$	Signal Path	Function
L	A1 → Y2, Y1 → V <sub>CC1</sub>	Enable Bypass Mode
H	A1 → Y1, A2 → Y2	Enable Normal Mode

\*Patent Pending

REV. 0

Information furnished by Analog Devices is believed to be accurate and reliable. However, no responsibility is assumed by Analog Devices for its use, nor for any infringements of patents or other rights of third parties that may result from its use. No license is granted by implication or otherwise under any patent or patent rights of Analog Devices. Trademarks and registered trademarks are the property of their respective companies.

# ADG3233—SPECIFICATIONS<sup>1</sup> ( $V_{CC1} = V_{CC2} = 1.65\text{ V to }3.6\text{ V}$ , $GND = 0\text{ V}$ , All specifications $T_{MIN}$ to $T_{MAX}$ , unless otherwise noted.)

Parameter	Symbol	Conditions	Min	Typ <sup>2</sup>	Max	Unit
<b>LOGIC INPUTS/OUTPUTS<sup>3</sup></b>						
Input High Voltage <sup>4</sup>	$V_{IH}$	( $V_{CC2} = 1.65\text{ V to }3.6\text{ V}$ , $GND = 0\text{ V}$ ) $V_{CC1} = 3.0\text{ V to }3.6\text{ V}$ $V_{CC1} = 2.3\text{ V to }2.7\text{ V}$ $V_{CC1} = 1.65\text{ V to }1.95\text{ V}$	1.35 1.35 0.65 $V_{CC}$			V V V
Input Low Voltage <sup>4</sup>	$V_{IL}$	$V_{CC1} = 3.0\text{ V to }3.6\text{ V}$ $V_{CC1} = 2.3\text{ V to }2.7\text{ V}$ $V_{CC1} = 1.65\text{ V to }1.95\text{ V}$			0.8 0.7 0.35 $V_{CC}$	V V V
Output High Voltage (Y1)	$V_{OH}$	$I_{OH} = -100\text{ }\mu\text{A}$ , $V_{CC1} = 3.0\text{ V to }3.6\text{ V}$ $V_{CC1} = 2.3\text{ V to }2.7\text{ V}$ $V_{CC1} = 1.65\text{ V to }1.95\text{ V}$ $I_{OH} = -4\text{ mA}$ , $V_{CC1} = 2.3\text{ V to }2.7\text{ V}$ $V_{CC1} = 1.65\text{ V to }1.95\text{ V}$ $I_{OH} = -8\text{ mA}$ , $V_{CC1} = 3.0\text{ V to }3.6\text{ V}$	2.4 2.0 $V_{CC} - 0.45$ 2.0 $V_{CC} - 0.45$ 2.4			V V V V V V
Output Low Voltage (Y1)	$V_{OL}$	$I_{OL} = +100\text{ }\mu\text{A}$ , $V_{CC1} = 3.0\text{ V to }3.6\text{ V}$ $V_{CC1} = 2.3\text{ V to }2.7\text{ V}$ $V_{CC1} = 1.65\text{ V to }1.95\text{ V}$ $I_{OL} = +4\text{ mA}$ , $V_{CC1} = 2.3\text{ V to }2.7\text{ V}$ $V_{CC1} = 1.65\text{ V to }1.95\text{ V}$ $I_{OL} = +8\text{ mA}$ , $V_{CC1} = 3.0\text{ V to }3.6\text{ V}$			0.40 0.40 0.45 0.40 0.45 0.40	V V V V V V
<b>LOGIC OUTPUTS<sup>3</sup></b>						
Output High Voltage (Y2)	$V_{OH}$	( $V_{CC1} = 1.65\text{ V to }3.6\text{ V}$ , $GND = 0\text{ V}$ ) $I_{OH} = -100\text{ }\mu\text{A}$ , $V_{CC2} = 3.0\text{ V to }3.6\text{ V}$ $V_{CC2} = 2.3\text{ V to }2.7\text{ V}$ $V_{CC2} = 1.65\text{ V to }1.95\text{ V}$ $I_{OH} = -4\text{ mA}$ , $V_{CC2} = 2.3\text{ V to }2.7\text{ V}$ $V_{CC2} = 1.65\text{ V to }1.95\text{ V}$ $I_{OH} = -8\text{ mA}$ , $V_{CC2} = 3.0\text{ V to }3.6\text{ V}$	2.4 2.0 $V_{CC} - 0.45$ 2.0 $V_{CC} - 0.45$ 2.4			V V V V V V
Output Low Voltage (Y2)	$V_{OL}$	$I_{OL} = +100\text{ }\mu\text{A}$ , $V_{CC2} = 3.0\text{ V to }3.6\text{ V}$ $V_{CC2} = 2.3\text{ V to }2.7\text{ V}$ $V_{CC2} = 1.65\text{ V to }1.95\text{ V}$ $I_{OL} = +4\text{ mA}$ , $V_{CC2} = 2.3\text{ V to }2.7\text{ V}$ $V_{CC2} = 1.65\text{ V to }1.95\text{ V}$ $I_{OL} = +8\text{ mA}$ , $V_{CC2} = 3.0\text{ V to }3.6\text{ V}$			0.40 0.40 0.45 0.40 0.45 0.40	V V V V V V
<b>SWITCHING CHARACTERISTICS<sup>4, 5</sup></b>						
$V_{CC} = V_{CC1} = V_{CC2} = 3.3\text{ V} \pm 0.3\text{ V}$						
Propagation Delay, $t_{PD}$						
A1 to Y1 Normal Mode	$t_{PHL}$ , $t_{PLH}$	$C_L = 30\text{ pF}$ , $V_T = V_{CC}/2$		3.5	5.4	ns
A2 to Y2 Normal Mode	$t_{PHL}$ , $t_{PLH}$	$C_L = 30\text{ pF}$ , $V_T = V_{CC}/2$		3.5	5.4	ns
A1 to Y2 Bypass Mode	$t_{PHL}$ , $t_{PLH}$	$C_L = 30\text{ pF}$ , $V_T = V_{CC}/2$		4	6.5	ns
ENABLE Time $\overline{EN}$ to Y1	$t_{EN}$	$C_L = 30\text{ pF}$ , $V_T = V_{CC}/2$		4	6	ns
DISABLE Time $\overline{EN}$ to Y1	$t_{DIS}$	$C_L = 30\text{ pF}$ , $V_T = V_{CC}/2$		2.8	4	ns
ENABLE Time $\overline{EN}$ to Y2	$t_{EN}$	$C_L = 30\text{ pF}$ , $V_T = V_{CC}/2$		4.5	6.5	ns
DISABLE Time $\overline{EN}$ to Y2	$t_{DIS}$	$C_L = 30\text{ pF}$ , $V_T = V_{CC}/2$		4	6.5	ns
$V_{CC} = V_{CC1} = V_{CC2} = 2.5\text{ V} \pm 0.2\text{ V}$						
Propagation Delay, $t_{PD}$						
A1 to Y1 Normal Mode	$t_{PHL}$ , $t_{PLH}$	$C_L = 30\text{ pF}$ , $V_T = V_{CC}/2$		4.5	6.2	ns
A2 to Y2 Normal Mode	$t_{PHL}$ , $t_{PLH}$	$C_L = 30\text{ pF}$ , $V_T = V_{CC}/2$		4.5	6.2	ns
A1 to Y2 Bypass Mode	$t_{PHL}$ , $t_{PLH}$	$C_L = 30\text{ pF}$ , $V_T = V_{CC}/2$		4.5	6.5	ns
ENABLE Time $\overline{EN}$ to Y1	$t_{EN}$	$C_L = 30\text{ pF}$ , $V_T = V_{CC}/2$		5	7.2	ns
DISABLE Time $\overline{EN}$ to Y1	$t_{DIS}$	$C_L = 30\text{ pF}$ , $V_T = V_{CC}/2$		3.2	4.7	ns
ENABLE Time $\overline{EN}$ to Y2	$t_{EN}$	$C_L = 30\text{ pF}$ , $V_T = V_{CC}/2$		5	7.7	ns
DISABLE Time $\overline{EN}$ to Y2	$t_{DIS}$	$C_L = 30\text{ pF}$ , $V_T = V_{CC}/2$		4.8	7.2	ns
$V_{CC} = V_{CC1} = V_{CC2} = 1.8\text{ V} \pm 0.15\text{ V}$						
Propagation Delay, $t_{PD}$						
A1 to Y1 Normal Mode	$t_{PHL}$ , $t_{PLH}$	$C_L = 30\text{ pF}$ , $V_T = V_{CC}/2$		6.7	10	ns
A2 to Y2 Normal Mode	$t_{PHL}$ , $t_{PLH}$	$C_L = 30\text{ pF}$ , $V_T = V_{CC}/2$		6.5	10	ns
A1 to Y2 Bypass Mode	$t_{PHL}$ , $t_{PLH}$	$C_L = 30\text{ pF}$ , $V_T = V_{CC}/2$		6.5	10.25	ns
ENABLE Time $\overline{EN}$ to Y1	$t_{EN}$	$C_L = 30\text{ pF}$ , $V_T = V_{CC}/2$		7	10.5	ns
DISABLE Time $\overline{EN}$ to Y1	$t_{DIS}$	$C_L = 30\text{ pF}$ , $V_T = V_{CC}/2$		4.4	6.5	ns
ENABLE Time $\overline{EN}$ to Y2	$t_{EN}$	$C_L = 30\text{ pF}$ , $V_T = V_{CC}/2$		7	12	ns
DISABLE Time $\overline{EN}$ to Y2	$t_{DIS}$	$C_L = 30\text{ pF}$ , $V_T = V_{CC}/2$		6.5	10.5	ns

Parameter	Symbol	Conditions	Min	Typ <sup>2</sup>	Max	Unit
SWITCHING CHARACTERISTICS <sup>4, 5</sup> (continued)						
Input Leakage Current	$I_I$	$0 \leq V_{IN} \leq 3.6 \text{ V}$			$\pm 1$	$\mu\text{A}$
Output Leakage Current	$I_O$	$0 \leq V_{IN} \leq 3.6 \text{ V}$			$\pm 1$	$\mu\text{A}$
POWER REQUIREMENTS						
Power Supply Voltages	$V_{CC1}$		1.65		3.6	V
	$V_{CC2}$		1.65		3.6	V
Quiescent Power Supply Current	$I_{CC1}$	Digital Inputs = 0 V or $V_{CC}$			2	$\mu\text{A}$
	$I_{CC2}$	Digital Inputs = 0 V or $V_{CC}$			2	$\mu\text{A}$
Increase in $I_{CC}$ per Input	$\Delta I_{CC1}$	$V_{CC} = 3.6 \text{ V}$ , One Input at 3.0 V; Others at $V_{CC}$ or GND			0.75	$\mu\text{A}$

#### NOTES

<sup>1</sup> Temperature range is as follows: B Version:  $-40^\circ\text{C}$  to  $+85^\circ\text{C}$ .

<sup>2</sup> All typical values are at  $V_{CC} = V_{CC1} = V_{CC2}$ ,  $T_A = 25^\circ\text{C}$ , unless otherwise stated.

<sup>3</sup>  $V_{IL}$  and  $V_{IH}$  levels are specified with respect to  $V_{CC1}$ ,  $V_{OH}$  and  $V_{OL}$  levels for Y1 are specified with respect to  $V_{CC1}$ , and  $V_{OH}$  and  $V_{OL}$  levels are specified for Y2 with respect to  $V_{CC2}$ .

<sup>4</sup> Guaranteed by design, not subject to production test.

<sup>5</sup> See Test Circuits and Waveforms.

Specifications subject to change without notice.

# ADG3233

## ABSOLUTE MAXIMUM RATINGS\*

( $T_A = 25^\circ\text{C}$ , unless otherwise noted.)

$V_{CC}$ to GND	-0.3 V to +4.6 V
Digital Inputs to GND	-0.3 V to +4.6 V
A1, $\overline{\text{EN}}$	-0.3 V to +4.6 V
A2	-0.3 V to $V_{CC1} + 0.3\text{V}$
DC Output Current	25 mA
Operating Temperature Range	
Industrial (B Version)	-40°C to +85°C
Storage Temperature Range	-65°C to +150°C
Junction Temperature	150°C
8-Lead MSOP	
$\theta_{JA}$ Thermal Impedance	206°C/W
$\theta_{JC}$ Thermal Impedance	43°C/W
8-Lead SOT-23	
$\theta_{JA}$ Thermal Impedance	211°C/W

Lead Temperature, Soldering (10 sec)	300°C
IR Reflow, Peak Temperature (<20 sec)	235°C

\*Stresses above those listed under Absolute Maximum Ratings may cause permanent damage to the device. This is a stress rating only; functional operation of the device at these or any other conditions above those listed in the operational sections of this specification is not implied. Exposure to absolute maximum rating conditions for extended periods may affect device reliability. Only one absolute maximum rating may be applied at any one time.

## ORDERING GUIDE

Model	Temperature Range	Package Description	Branding	Package Option
ADG3233BRJ-REEL	-40°C to +85°C	SOT-23	W1B	RJ-8
ADG3233BRJ-REEL7	-40°C to +85°C	SOT-23	W1B	RJ-8
ADG3233BRM	-40°C to +85°C	MSOP	W1B	RM-8
ADG3233BRM-REEL	-40°C to +85°C	MSOP	W1B	RM-8
ADG3233BRM-REEL7	-40°C to +85°C	MSOP	W1B	RM-8

## PIN CONFIGURATIONS

8-Lead SOT-23 Package (RJ-8)

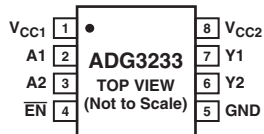

8-Lead MSOP Package (RM-8)

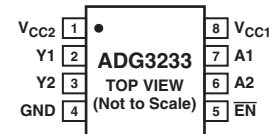

## PIN FUNCTION DESCRIPTIONS

Pin		Mnemonic	Description
RJ-8	RM-8		
1	8	$V_{CC1}$	Supply Voltage 1, can be any supply voltage from 1.65 V to 3.6 V.
8	1	$V_{CC2}$	Supply Voltage 2, can be any supply voltage from 1.65 V to 3.6 V.
2	7	A1	Input Referred to $V_{CC1}$ .
3	6	A2	Input Referred to $V_{CC2}$ .
7	2	Y1	Output Referred to $V_{CC1}$ .
6	3	Y2	Output Referred to $V_{CC2}$ . Voltage levels appearing at Y2 will be translated from $V_{CC1}$ voltage level to a $V_{CC2}$ voltage level.
4	5	$\overline{\text{EN}}$	Active Low Device Enable. When low, bypass mode is enabled; when high, the device is in normal mode.
5	4	GND	Device Ground.

## CAUTION

ESD (electrostatic discharge) sensitive device. Electrostatic charges as high as 4000 V readily accumulate on the human body and test equipment and can discharge without detection. Although the ADG3233 features proprietary ESD protection circuitry, permanent damage may occur on devices subjected to high energy electrostatic discharges. Therefore, proper ESD precautions are recommended to avoid performance degradation or loss of functionality.



# Typical Performance Characteristics—ADG3233

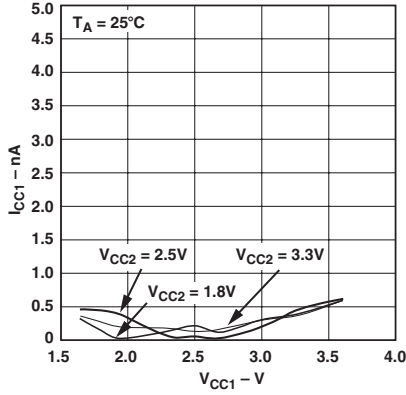

TPC 1.  $I_{CC1}$  vs.  $V_{CC1}$

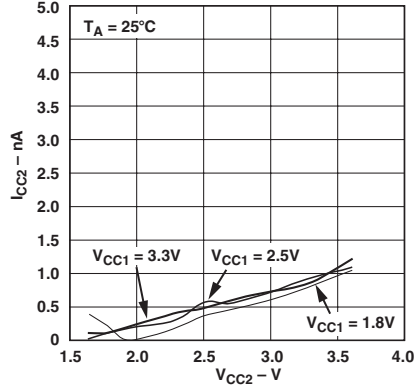

TPC 2.  $I_{CC2}$  vs.  $V_{CC2}$

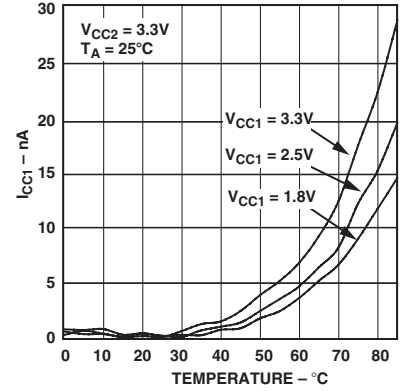

TPC 3.  $I_{CC1}$  vs. Temperature

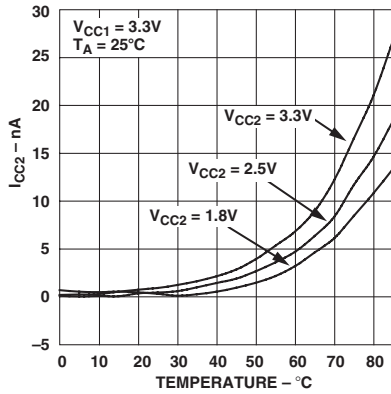

TPC 4.  $I_{CC2}$  vs. Temperature

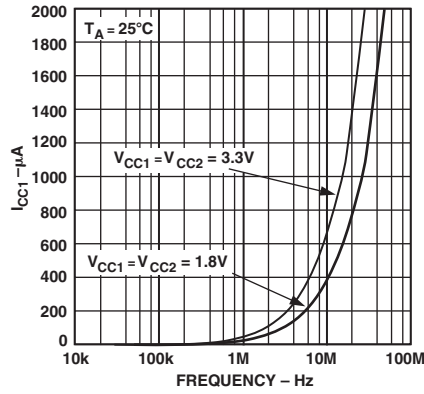

TPC 5.  $I_{CC1}$  vs. Frequency, Normal Mode

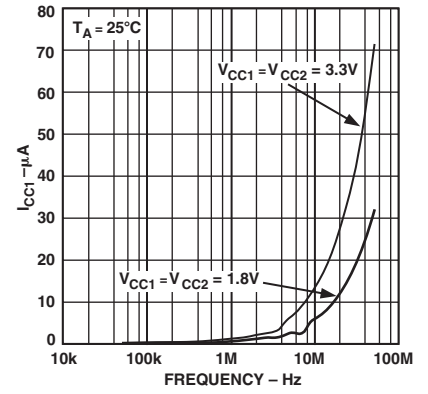

TPC 6.  $I_{CC1}$  vs. Frequency, Bypass Mode

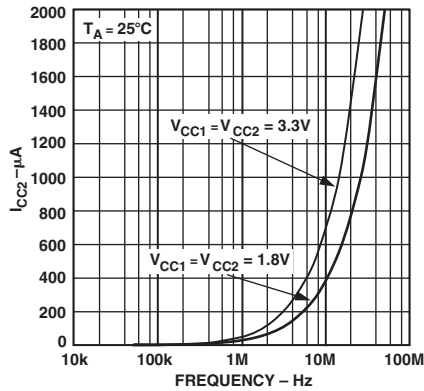

TPC 7.  $I_{CC2}$  vs. Frequency, Normal Mode

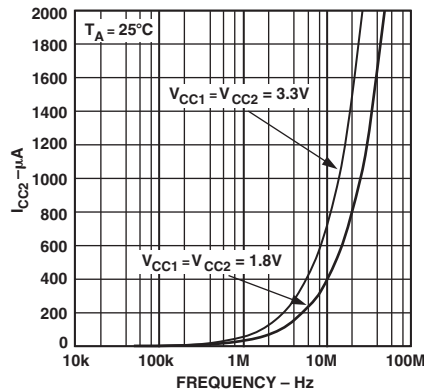

TPC 8.  $I_{CC2}$  vs. Frequency, Bypass Mode

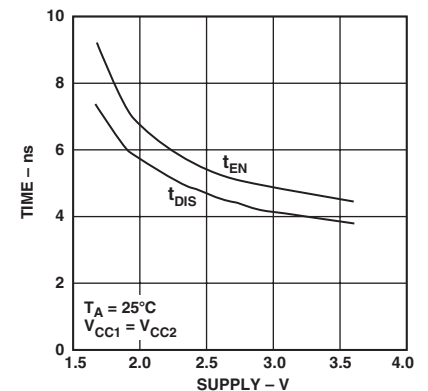

TPC 9. Y1 Enable, Disable Time vs. Supply

# ADG3233

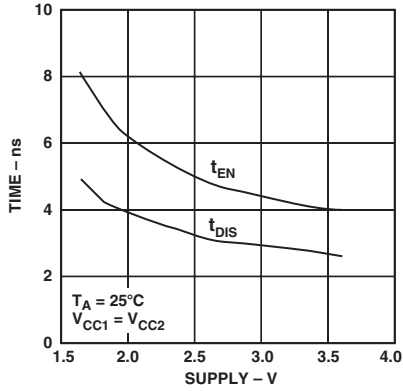

TPC 10. Y2 Enable, Disable Time vs. Supply

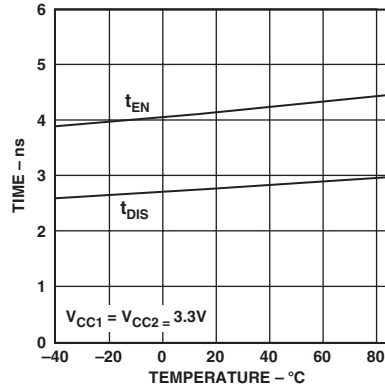

TPC 11. Y1 Enable, Disable Time vs. Temperature

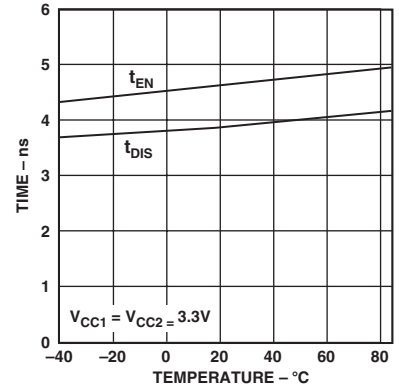

TPC 12. Y2 Enable, Disable Time vs. Temperature

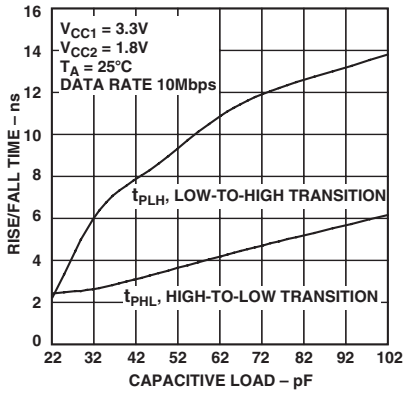

TPC 13. Rise/Fall Time vs. Capacitive Load, A1-Y1, A2-Y2

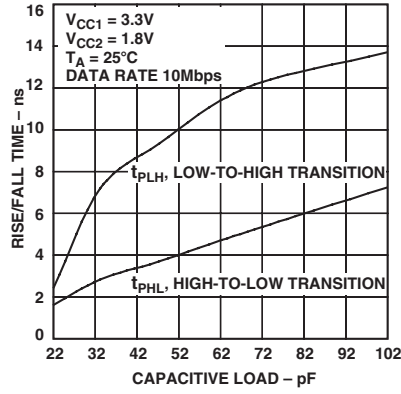

TPC 14. Rise/Fall Time vs. Capacitive Load, A1-Y2, Bypass Mode

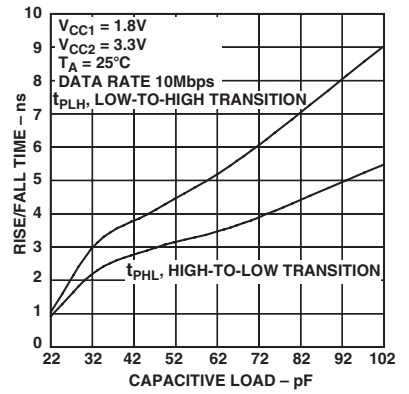

TPC 15. Rise/Fall Time vs. Capacitive Load, A1-Y1, A2-Y2

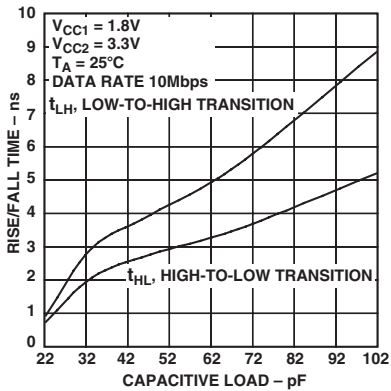

TPC 16. Rise/Fall Time vs. Capacitive Load, A1-Y2, Bypass Mode

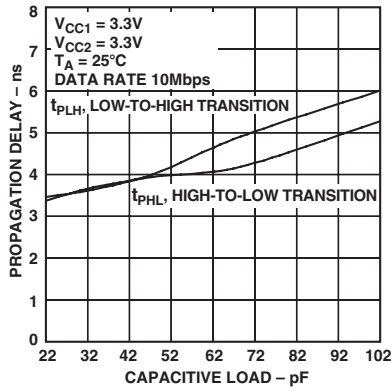

TPC 17. Propagation Delay vs. Capacitive Load A1 to Y1

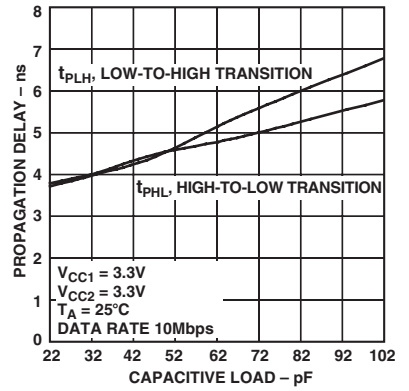

TPC 18. Propagation Delay vs. Capacitive Load A2 to Y2

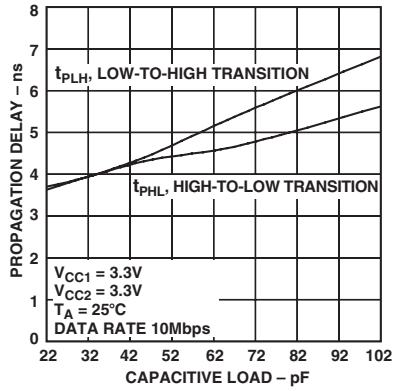

TPC 19. Propagation Delay vs. Capacitive Load A1 to Y2, Bypass Mode

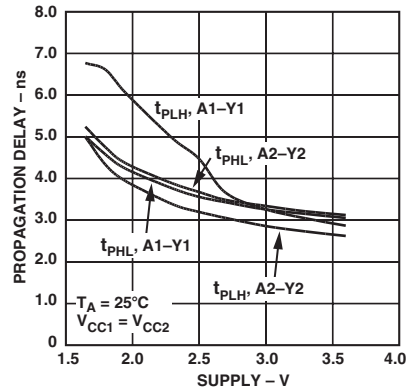

TPC 20. Propagation Delay vs. Supply, Normal Mode

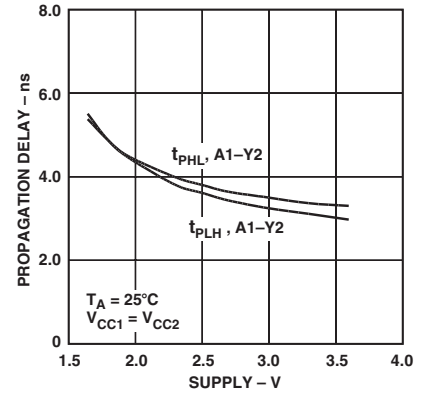

TPC 21. Propagation Delay vs. Supply, Bypass Mode

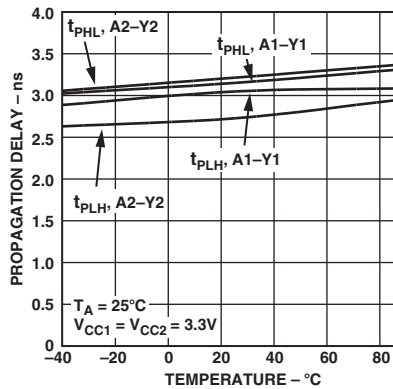

TPC 22. Propagation Delay vs. Temperature, Normal Mode

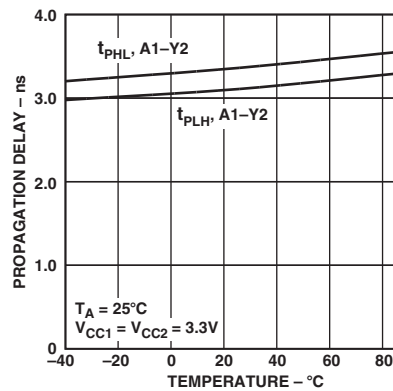

TPC 23. Propagation Delay vs. Temperature, Bypass Mode

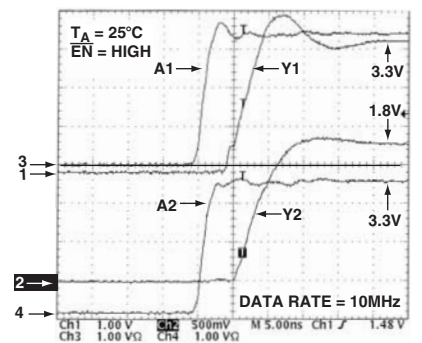

TPC 24. Normal Mode  $V_{CC1} = 3.3V$ ,  $V_{CC2} = 1.8V$

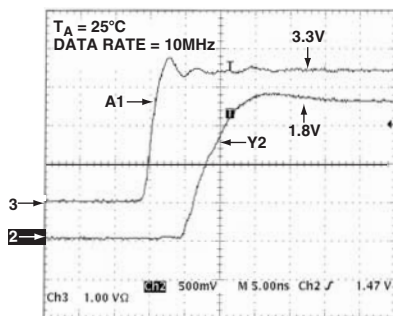

TPC 25. Bypass Mode,  $V_{CC1} = 3.3V$ ,  $V_{CC2} = 1.8V$

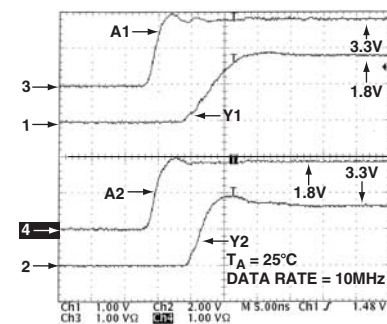

TPC 26. Normal Mode  $V_{CC1} = 1.8V$ ,  $V_{CC2} = 3.3V$

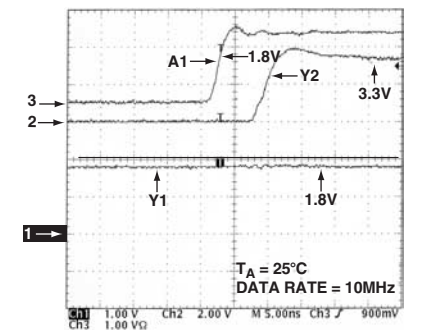

TPC 27. Bypass Mode,  $V_{CC1} = 1.8V$ ,  $V_{CC2} = 3.3V$

# ADG3233

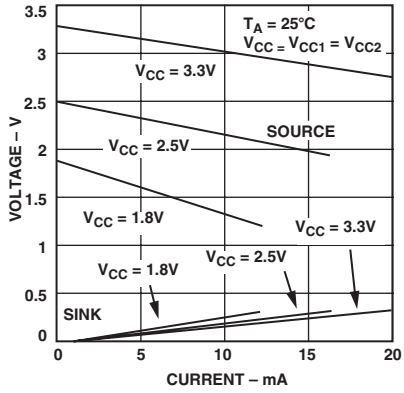

TPC 28. Y1 and Y2 Source and Sink Current

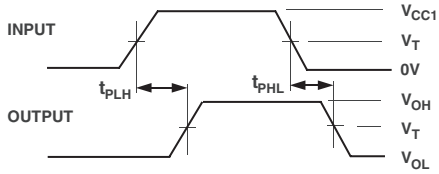

Figure 1. Propagation Delay

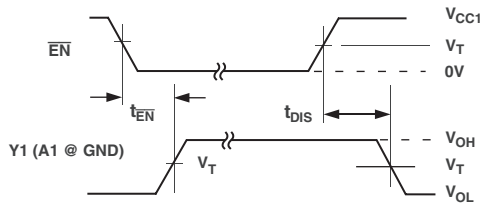

Figure 2. Y1 Enable and Disable Times

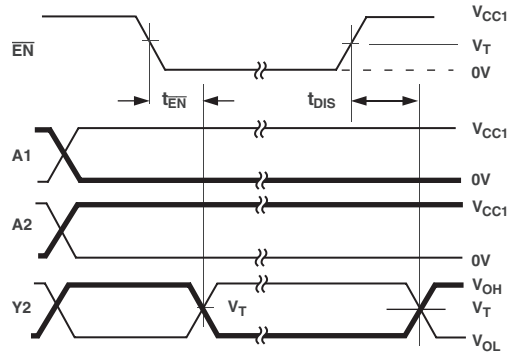

Figure 3. Y2 Enable and Disable Times



**DESCRIPTION**

The ADG3233 is a bypass switch designed on a submicron process that operates from supplies as low as 1.65 V. The device is guaranteed for operation over the supply range 1.65 V to 3.6 V. It operates from two supply voltages, allowing bidirectional level translation, i.e., it translates low voltages to higher voltages and vice versa. The signal path is unidirectional, meaning data may only flow from A to Y.

**A1 and  $\overline{\text{EN}}$  Input**

The A1 and enable ( $\overline{\text{EN}}$ ) inputs have  $V_{\text{IL}}/V_{\text{IH}}$  logic levels so that the part can accept logic levels of  $V_{\text{OL}}/V_{\text{OH}}$  from Device 0 or the controlling device independent of the value of the supply being used by the controlling device. These inputs (A1,  $\overline{\text{EN}}$ ) are capable of accepting inputs outside the  $V_{\text{CC1}}$  supply range. For example, the  $V_{\text{CC1}}$  supply applied to the bypass switch could be 1.8 V while Device 0 could be operating from a 2.5 V or 3.3 V supply

rail, there are no internal diodes to the supply rails, so the device can handle inputs above the supply but inside the absolute maximum ratings.

**Normal Operation**

Figure 4 shows the bypass switch being used in normal mode. In this mode, the signal paths are from A1 to Y1 and A2 to Y2. The device will level translate the signal applied to A1 to a  $V_{\text{CC1}}$  logic level (this level translation can be either to a higher or lower supply) and route the signal to the Y1 output, which will have standard  $V_{\text{OL}}/V_{\text{OH}}$  levels for  $V_{\text{CC1}}$  supplies. The signal is then passed through Device 1 and back to the A2 input pin of the bypass switch.

The logic level inputs of A2 are with respect to the  $V_{\text{CC1}}$  supply. The signal will be level translated from  $V_{\text{CC1}}$  to  $V_{\text{CC2}}$  and routed to the Y2 output pin of the bypass switch. Y2 output logic levels are with respect to the  $V_{\text{CC2}}$  supply.

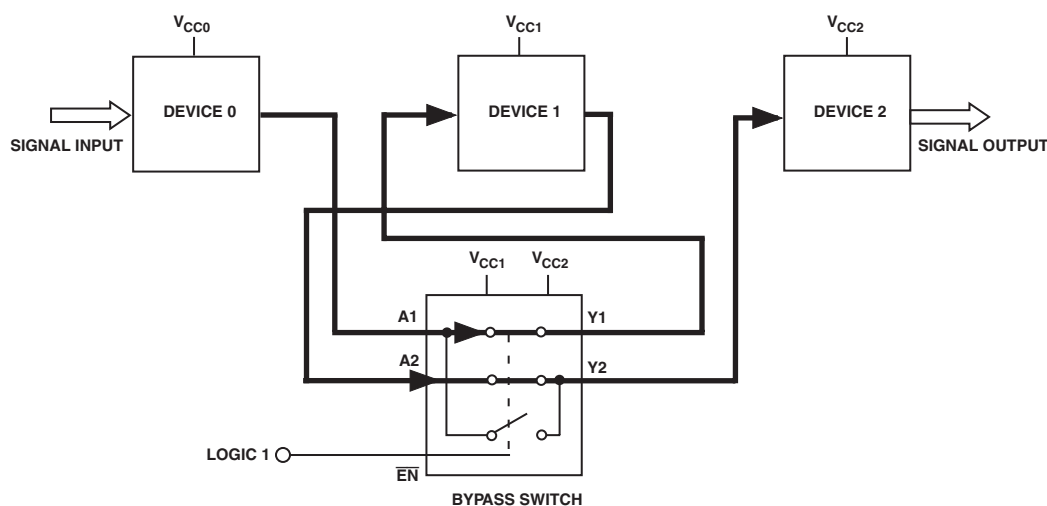

Figure 4. Bypass Switch in Normal Mode

# ADG3233

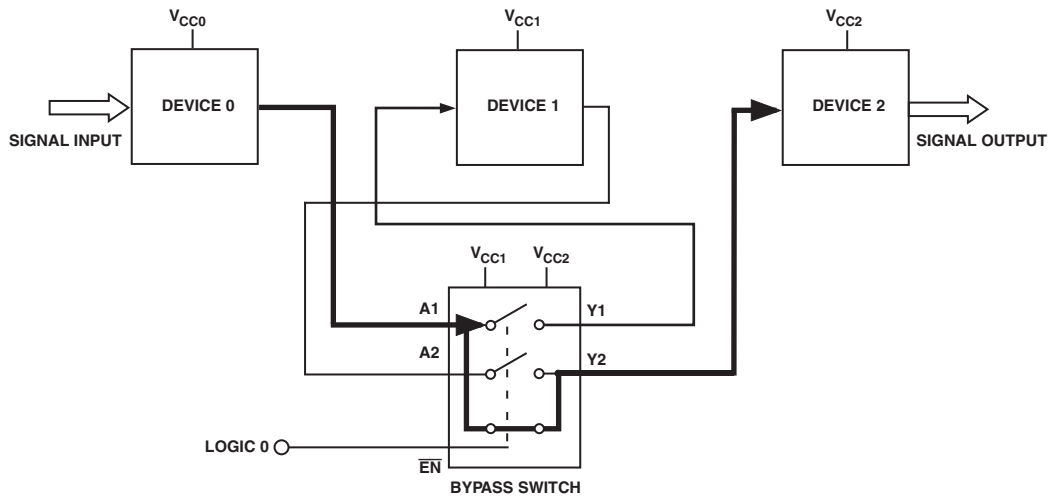

Figure 5. Bypass Switch in Bypass Mode

## Bypass Operation

Figure 5 illustrates the device as used in bypass operation. The signal path is now from A1 directly to Y2, thus bypassing Device 1 completely. The signal will be level translated to a  $V_{CC2}$  logic level and available on Y2, where it may be applied

directly to the input of Device 2. In bypass mode, Y1 is pulled up to  $V_{CC1}$ .

The three supplies in Figures 4 and 5 may be any combination of supplies, i.e.,  $V_{CC0}$ ,  $V_{CC1}$ , and  $V_{CC2}$  may be any combination of supplies, for example, 1.8 V, 2.5 V, and 3.3 V.

OUTLINE DIMENSIONS

8-Lead Mini Small Outline Package [MSOP]  
(RM-8)

Dimensions shown in millimeters

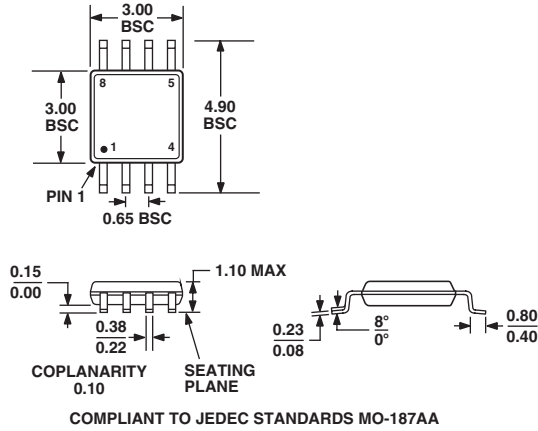

8-Lead Small Outline Transistor Package [SOT-23]  
(RJ-8)

Dimensions shown in millimeters

