

Panasonic®

5.8 GHz Digital Cordless Phone

Operating Instructions

Model No. **KX-TG5050**

Pulse-or-tone dialing capability



The unit is Caller ID compatible. To display the Caller's name and phone number, you must subscribe to Caller ID service.

PLEASE READ BEFORE USE AND SAVE.

Charge the battery for 6 hours before initial use.

Panasonic World Wide Web address: <http://www.panasonic.com>
for customers in the USA or Puerto Rico

For Best Performance

Battery charge

The handset is powered by a rechargeable Nickel-Metal Hydride (Ni-MH) battery. Charge the battery for **6 hours** before initial use (p. 10).

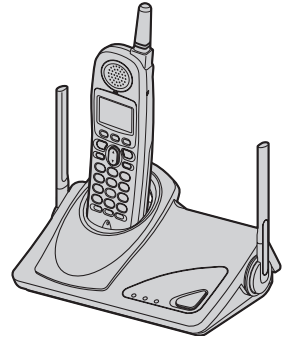

Base unit location/Noise

Calls are transmitted between the base unit and handset using wireless radio waves. **For maximum distance and noise-free operation**, the recommended base unit location is:

Away from electrical appliances such as a TV, personal computer or another cordless phone.

In a HIGH and CENTRAL location with no obstructions such as walls.

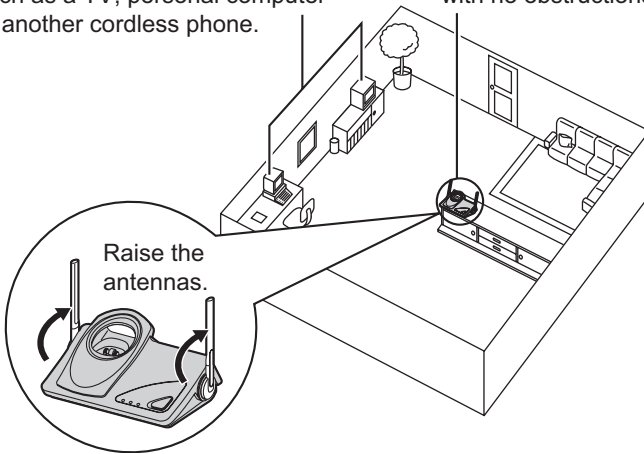

Note:

- If you use the handset near a microwave oven which is being used, noise may be heard from the receiver or the speaker. Move away from the microwave oven and closer to the base unit.
- If you use the handset near another cordless phone's base unit, noise may be heard. Move away from the other cordless phone's base unit and closer to your base unit.

Contents

Preparation

Location of Controls	6
Display	8
Installation	9
Connections	9
Installing the Battery in the Handset	10
Battery Charge	10
Programmable Settings	12
Programming Guidelines	12
Function Menu Table	13
Display Language	14
Dialing Mode	14
Line Mode	15
Auto Talk	15
Ringer Volume	16
Ringer Tone	17
LCD Contrast	18
Message Alert	18

Basic Operation

Making Calls	19
Answering Calls	22
Caller ID Service	23
Using the Caller List	24
Viewing the Caller List	24
Calling Back from the Caller List	25
Editing the Caller's Phone Number	26
Caller ID Number Auto Edit	27
Storing Caller Information in the Phone Book	28
Erasing Caller Information	28

Advanced Operation

Phone Book	29
Storing Names and Numbers	29
Dialing from the Phone Book	31
Chain Dial	32
Editing an Item in the Phone Book	33
Erasing an Item in the Phone Book	33
Voice Mail Service	34
Storing a Voice Mail Access Number	34
Setting Voice Mail (VM) Tone Detection	35
Listening to Voice Mail Messages	36
Special Features	37
Handset Locator	37
Muting Your Conversation	37
Temporary Tone Dialing (For Rotary or Pulse Service Users)	37
For Call Waiting Service Users	38
Using the PAUSE Button (For PBX Line/Long Distance Calls)	38
FLASH Button	39
Key Tone	40
Re-registering the Handset	40

Useful Information

Belt Clip	41
Optional Headset	41
Wall Mounting	42
Direct Commands	45
If the Following Appear on Your Display...	47
Troubleshooting	48
openLCR Service for Caller IQ	51
Turning on or off Caller IQ Feature	51
Downloading Data	52
Important Safety Instructions	55
FCC and Other Information	56
Index	59
Warranty	61
Specifications	63

Important

Throughout these Operating Instructions, **Handset** and **Base Unit** are used to indicate with which unit an operation can be performed.

Handset : Perform with the handset.

Base Unit : Perform with the base unit.

Handset & Base Unit : Perform with the handset and base unit together.

How to use the soft keys/navigator key

Handset soft keys

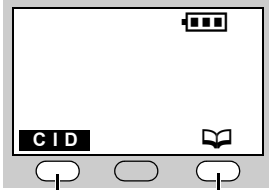

Three soft keys are used to select functions displayed directly above each key. Functions displayed above each key will change depending on the state of use.

On this sample display, “**CID**” and “” are displayed above the soft keys.

Pressing the right soft key selects the Phone Book “”.



Pressing the left soft key to review Caller ID information in the Caller List “**CID**”.



- When a function name does not appear above a soft key, the soft key has no function.



Throughout these Operating Instructions, the soft keys are indicated by their icons, such as **CID** and .

Handset navigator key



Scrolls up [] and down [] the function menu, the Caller List and the phone book.

Increases [] or decreases [] the handset ringer and receiver/speaker volumes.

Throughout these Operating Instructions, the handset navigator key is indicated by the arrows [] or [].

Display

Handset

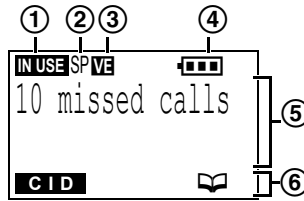

① "IN USE" functions as follows.

Off (invisible)	The line is free.
On	The line is in use.
Flashing	A call is on hold.
Flashing rapidly	A call is being received.

② "SP" is shown when you are using the speakerphone.

③ "VE" indicates Voice Enhancer mode is on (p. 21).

④ The battery icon indicates battery strength (p. 10).

⑤ The display shows the dialed number, call status, programming options, phone book items, Caller ID information, etc.

⑥ The icons on the bottom line indicate the functions of the corresponding soft keys which are located directly below the display (p. 7).

Ex. The soft key below "☰" (phone book icon) is used when storing or viewing phone book items (p. 29, 31).

Installation

Connections

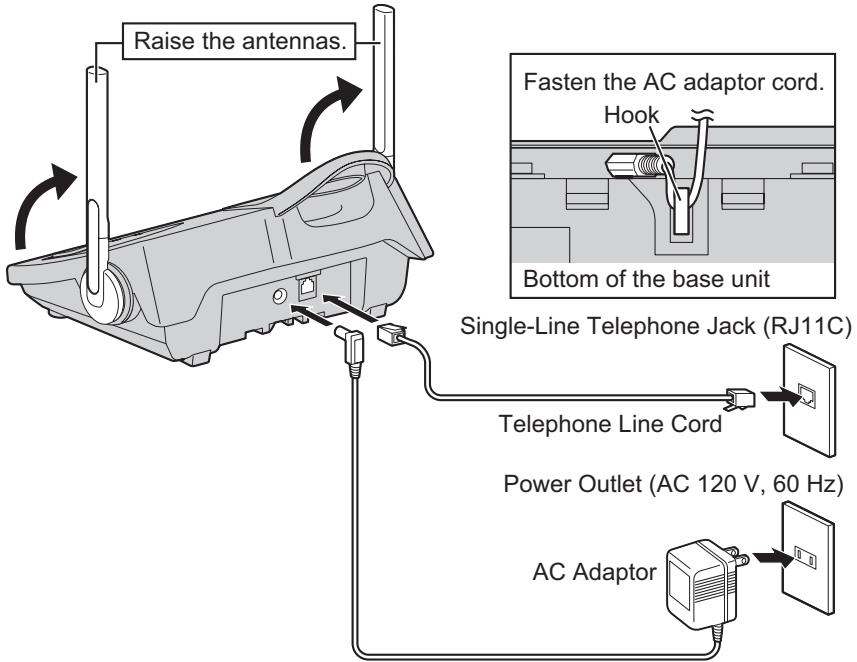

- USE ONLY WITH Panasonic AC ADAPTOR PQLV1 (Order No. PQLV1Z).
- The AC adaptor must remain connected at all times. (It is normal for the adaptor to feel warm during use.)
- If your unit is connected to a PBX which does not support Caller ID and voice mail services, you cannot access those services.
- This unit will not function during a power failure. We recommend connecting a standard telephone to the same telephone line or to the same telephone jack using the Panasonic KX-J66 T-adaptor.

Installation

Installing the Battery in the Handset

Insert the battery (①), and press it down until it snaps into the compartment (②). Close the cover.

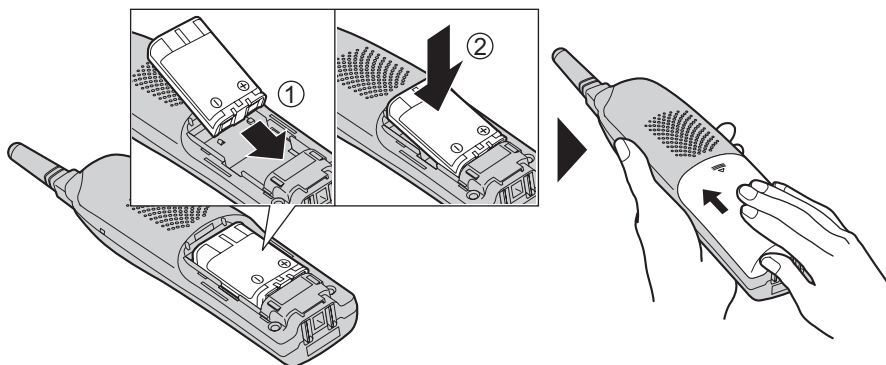

To replace the battery:

Press the notch on the cover firmly and slide it as indicated by the arrow. Replace the old battery with a new one (p. 11). Close the cover and charge the handset for 6 hours.



Battery Charge

Place the handset on the base unit for **6 hours** before initial use.

- The unit beeps once, the CHARGE indicator lights and "Charging" is displayed.
- When the battery is fully charged, "Charge completed" is displayed if there are no new calls in the Caller List.

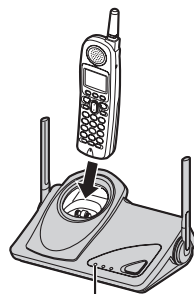

CHARGE Indicator

Battery strength

You can confirm the battery strength on the handset display. Battery strength is indicated by the icons shown in the chart to the right.



Display prompt	Battery strength
	Fully charged
	Medium
	Low
(flashing)	Needs to be recharged.
	Discharged

Recharge

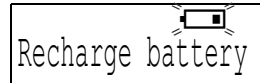

Recharge the battery when:

- “Recharge battery” is displayed on the handset,
- “” flashes, or
- the handset beeps intermittently while it is in use.



- The display will continually indicate “Recharge battery” and/or “” will flash when the handset battery is charged for less than 15 minutes and the handset is lifted off the base unit.
- If the battery has been discharged, the handset will display “Charge for 6 HRS” and “” when you place the handset on the base unit. The handset will not work unless the battery is charged. Continue charging.

Battery replacement:

If you cleaned the charge contacts and fully charged the battery, but after a few telephone calls, “Recharge battery” is displayed and/or “” continues to flash, or “Charge for 6 HRS” and “” are displayed, the battery may need to be replaced. Please order a new Panasonic HHR-P104 battery at the telephone number shown on page 2. To replace the battery, see page 10.

A nickel metal hydride battery that is recyclable powers the product you have purchased. Please call 1-800-8-BATTERY for information on how to recycle this battery.



Battery information

After your Panasonic battery is fully charged, you can expect the following performance:

Operation	Operating time
While in use (TALK)	Up to 5 hours
While not in use (Standby)	Up to 11 days
While using the Clarity Booster feature (p. 21)	Up to 3 hours

- A fully charged battery will give you up to 5 hours of continuous talk time, or keep your handset in Standby mode to receive incoming calls for up to 11 days (if no phone calls are made). Battery power is consumed whenever the handset is off of the base unit, even when the handset is not in use. The longer you leave the handset off of the base unit, the time you can actually talk on the handset will be shortened. Actual battery performance depends on a combination of how often the handset is in TALK mode and how often it is in Standby mode.
- **Clean the charge contacts of the handset and the base unit with a soft, dry cloth once a month. Clean more often if the unit is subject to grease, dust or high humidity.** Otherwise the battery may not charge properly.
- If the battery is fully charged, you do not have to place the handset on the base unit until “Recharge battery” is displayed and/or “” flashes. This will maximize the battery life.
- If you want to keep the battery fully charged at all times, place the handset on the base unit when the handset is not used. The battery cannot be overcharged.
- When the Clarity Booster feature is turned on automatically or manually, battery operating time may be shortened (p. 21).

Programmable Settings

Programming Guidelines **Handset**

The unit has several programmable functions which can be selected from the function menu on the display (p. 13).

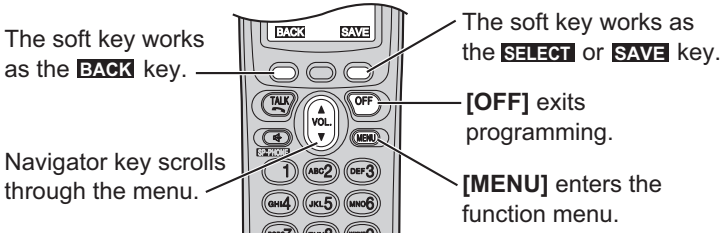

How to select a function item from the menu

Make sure the handset and base unit are not being used. The handset must be operated near the base unit and while off the base unit.

1 Press **[MENU]**.

- The main menu is displayed (p. 13).

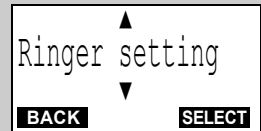

2 Scroll to the desired item by pressing **[▼]** or **[▲]**.

3 Press the soft key (**SELECT**) to select the desired item.

- ### 4 If the item has a sub-menu, select the menu item (p. 13). Repeat steps 2 and 3 until the desired item is displayed. If the item has no sub-menu, go to step 5.

5 Select the desired setting by pressing **[▼]** or **[▲]**, then press the soft key (**SAVE**).

- A confirmation tone will be heard and the setting will be saved.

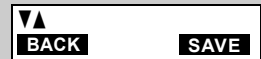

6 Press **[OFF]** to exit programming mode.

- To go back to the previous menu, press the soft key (**BACK**), or press the soft key (**SELECT**) while "--- (Go back) ---" is displayed. If you press this key in the main menu, the unit will exit programming mode.
- After programming is complete, the display will return to the main menu or the sub-menu depending on which menu the selected item is located. (See the menu table on page 13.)
- You can exit programming mode at any time by pressing **[OFF]**.
- If you do not press any buttons for 60 seconds, the unit will exit programming mode.
- If the unit detects a problem, an error message will be displayed (p. 47) and/or error beeps will sound.

Function Menu Table **Handset**

You can use the following functions to customize your unit. See the corresponding pages for function details.

- After pressing **[MENU]**, you can also program menu items directly by pressing (**[0]** to **[9]**, and **[#]**) instead of using the soft keys (p. 45, 46).

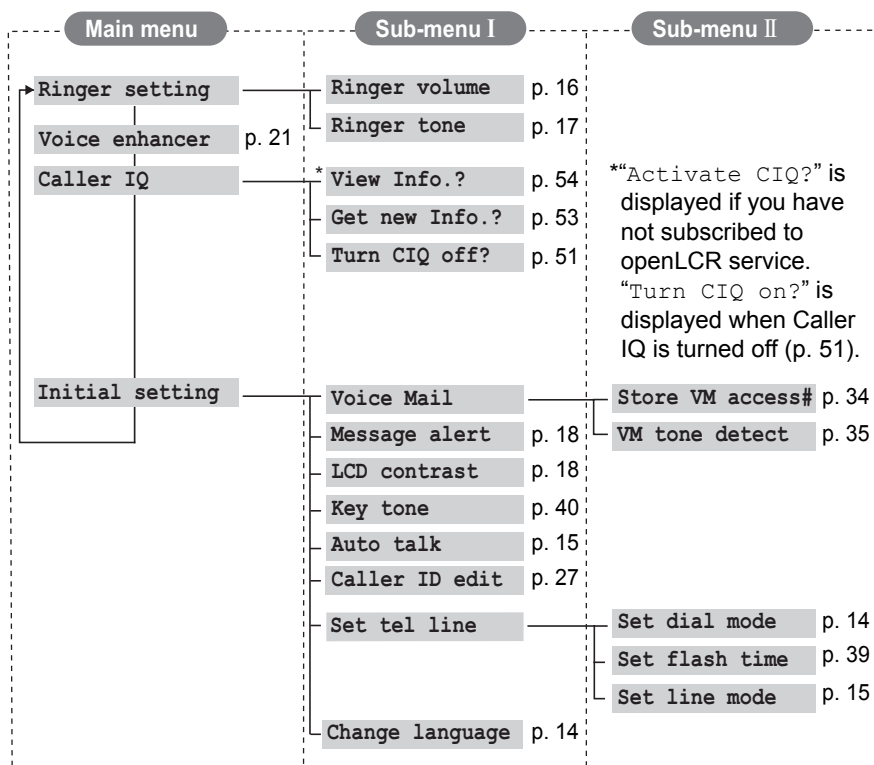

Programmable Settings

Display Language **Handset**

You can select either “English” or “Spanish” as the display language. The factory preset is “English”.

1 Press **[MENU]**.

2 Scroll to “Initial setting” by pressing **[▼]** or **[▲]**, then press the soft key **(SELECT)**.

Initial setting

3 Scroll to “Change language” by pressing **[▼]** or **[▲]**, then press the soft key **(SELECT)**.

Change language

4 To change from English to Spanish, press the soft key **(ESPAÑOL)**.

To change from Spanish to English, press the soft key **(ENGLISH)**.

- The display changes to the selected language.
- You can also select the display language by pressing **[▼]** or **[▲]**.

Display
:English

5 When Spanish is selected, press the soft key **(GUARDAR)**, then press **[OFF]**.
When English is selected, press the soft key **(SAVE)**, then press **[OFF]**.

- If you select a language you cannot read, change the display language again using direct commands (p. 45).

Dialing Mode **Handset**

If you have touch tone service, set the dialing mode to “Tone”. For rotary or pulse service, set to “Pulse”. The factory preset is “Tone”.

1 Press **[MENU]**.

2 Scroll to “Initial setting” by pressing **[▼]** or **[▲]**, then press the soft key **(SELECT)**.

Initial setting

3 Scroll to “Set tel line” by pressing **[▼]** or **[▲]**, then press the soft key **(SELECT)**.

Set tel line

4 Press the soft key **(SELECT)** at “Set dial mode”.

Set dial mode

5 Select “Pulse” or “Tone” by pressing **[▼]** or **[▲]**.

Set dial mode
:Tone

6 Press the soft key **(SAVE)**, then press **[OFF]**.

Line Mode **Handset**

The line mode is preset to “B” and generally should not be adjusted. If “**IN USE**” is not displayed on the handset properly, the line mode selection is incorrect. Set line mode to “A”.

1 Press **[MENU]**.

2 Scroll to “Initial setting” by pressing **[▼]** or **[▲]**, then press the soft key (**SELECT**).

Initial setting

3 Scroll to “Set tel line” by pressing **[▼]** or **[▲]**, then press the soft key (**SELECT**).

Set tel line

4 Scroll to “Set line mode” by pressing **[▼]** or **[▲]**, then press the soft key (**SELECT**).

Set line mode

5 Select “A” or “B” by pressing **[▼]** or **[▲]**.

Set line mode
:B

6 Press the soft key (**SAVE**), then press **[OFF]**.

Auto Talk **Handset**

The Auto Talk feature allows you to answer calls by simply lifting the handset off the base unit. You do not need to press **[↶]** or **[↷]**. The factory preset is OFF.

1 Press **[MENU]**.

2 Scroll to “Initial setting” by pressing **[▼]** or **[▲]**, then press the soft key (**SELECT**).

Initial setting

3 Scroll to “Auto talk” by pressing **[▼]** or **[▲]**, then press the soft key (**SELECT**).

Auto talk

4 Select “On” or “Off” by pressing **[▼]** or **[▲]**.

Auto talk
:Off

5 Press the soft key (**SAVE**), then press **[OFF]**.

- In order to view Caller ID information after you lift the handset to answer a call, leave the Auto Talk feature turned off.

Programmable Settings

Ringer Volume **Handset**

You can set the handset ringer volume to high, medium, low, or off. The factory preset is HIGH. If set to off, the handset will not ring for outside calls.

1 Press **[MENU]**.

2 Press the soft key (**SELECT**) at “Ringer setting”.

Ringer setting

3 Press the soft key (**SELECT**) at “Ringer volume”.

Ringer volume

4 Select the desired volume by pressing **[▼]** or **[▲]**.

- The volume will change and ring.
- The number of steps indicates the volume level.
- **To turn the ringer off**, press **[▼]** repeatedly until “Off ?” is displayed.

Ex. High

Ringer volume
Low  High

Ex. Off

Ringer volume
Off ?

5 Press the soft key (**SAVE**).

- If the handset ringer is turned off, the handset displays “Ringer off” while not in use. When there are new messages in your voice mailbox (p. 36), “Ringer off” is not displayed.
- You can also adjust the ringer volume while an outside call is ringing. Press **[▼]** or **[▲]** while the handset is ringing.

Temporary ringer off

While the handset is ringing for an outside call, you can turn the ringer off temporarily by pressing **[OFF]**. The handset will ring again as normal the next time a call is received.

Ringer Tone **Handset**

You can set the handset ringer to use one of 7 ringer patterns for outside calls. “Tone 1” to “Tone 3” are bell ringer patterns. “Melody 1” to “Melody 4” are preset melody patterns. The factory preset is “Tone 1”.

- If you subscribe to a Distinctive Ring Service (such as IDENTA-RING) from your telephone company with 2 or 3 consecutive rings, select a bell ringer pattern (Tone 1 to 3). If you select a melody pattern, you will not be able to distinguish lines by their ringers.
- If you select one of the melody ringer patterns, the ringer will continue to sound for several seconds if:
 - the caller hangs up before you answer the call, or
 - another person answers the call using another phone connected on the same line.

1 Press **[MENU]**.

2 Press the soft key (**SELECT**) at “Ringer setting”.

Ringer setting

3 Scroll to “Ringer tone” by pressing **[▼]** or **[▲]**, then press the soft key (**SELECT**).

Ringer tone

4 Select the desired ringer tone by pressing **[▼]** or **[▲]**.

- The handset will ring and the ringer tone will change. If the ringer volume has been turned off, the handset will not ring (p. 16).
- You can also select the ringer tone by pressing **[1]** to **[7]**.

Ringer tone
1:Tone 1

5 Press the soft key (**SAVE**), then press **[OFF]**.

Programmable Settings

LCD Contrast **Handset**

There are 6 levels of LCD contrast. The factory preset is “level 3”.

1 Press [MENU] .	
2 Scroll to “Initial setting” by pressing [▼] or [▲] , then press the soft key (SELECT).	Initial setting
3 Scroll to “LCD contrast” by pressing [▼] or [▲] , then press the soft key (SELECT).	LCD contrast
4 Select the desired contrast by pressing [▼] or [▲] . <ul style="list-style-type: none">• The contrast will change.• The number of steps indicates the contrast level.	Ex. Level 3 LCD contrast Low  High
5 Press the soft key (SAVE), then press [OFF] .	

Message Alert **Handset**

You can select whether or not the Ringer/Message Alert indicator on the handset will flash slowly when new messages in your voice mailbox have been recorded (p. 36). The factory preset is OFF.

1 Press [MENU] .	
2 Scroll to “Initial setting” by pressing [▼] or [▲] , then press the soft key (SELECT).	Initial setting
3 Scroll to “Message alert” by pressing [▼] or [▲] , then press the soft key (SELECT).	Message alert
4 Select “On” or “Off” by pressing [▼] or [▲] .	Message alert :Off
5 Press the soft key (SAVE), then press [OFF] .	

- The Ringer/Message Alert indicator will not flash for new messages while the handset is in use.
- The Ringer/Message Alert indicator acts as a ringer indicator and as a message alert indicator. This indicator will flash rapidly when a call is received whether this feature is on or off.
- Battery operating time may be shortened when using this feature (p. 11).

Making Calls

1 Press [**📞**].

- “Talk” is displayed.

2 Dial a phone number.

- The dialed number is displayed.
- After a few seconds, the display will show the length of the call.

3 To hang up, press [**OFF**] or place the handset on the base unit.

To have a hands-free phone conversation

1 Press [**📞**].

- “SP-phone” is displayed.

2 Dial a phone number.

- The dialed number is displayed.
- After a few seconds, the display will show the length of the call.

3 When the other party answers, talk into the microphone.

4 To hang up, press [**OFF**] or place the handset on the base unit.

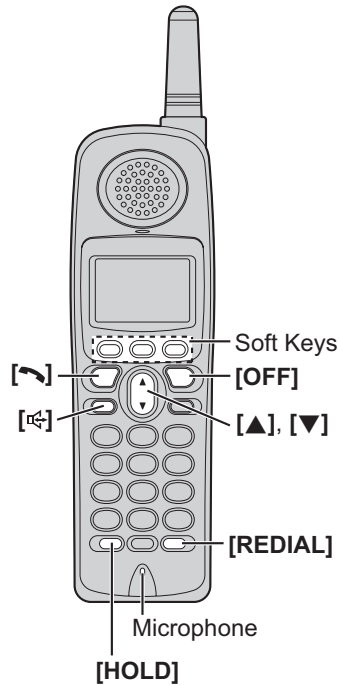

Hands-free Digital Duplex Speakerphone

For best performance, please note the following:

- Talk alternately with the other party in a quiet room.
- If you or the other party has difficulty hearing, press [**▼**] to decrease the speaker volume.
- While talking using [**📞**], you can switch to a hands-free phone conversation by pressing [**📞**]. To switch back to the receiver, press [**📞**].

Making Calls

To dial after confirming the entered number

1. Enter a phone number.



- If you misdial, press the soft key **(CLEAR)**. Enter the correct phone number.
 - If a pause is required when dialing, press the soft key **(PAUSE)** where needed (p. 38).
 - To cancel, press **[OFF]**.
2. Press **[↶]** or **[↷]**.
 3. To hang up, press **[OFF]** or place the handset on the base unit.

To adjust the receiver/speaker volume during a conversation

There are 3 volume levels for the receiver and 6 volume levels for the speaker.

To increase volume, press **[▲]**.

To decrease volume, press **[▼]**.

Ex. Receiver volume: High
Speaker volume: Level 6



- The display shows the current volume setting.
- If you try to increase/decrease volume when it is at the maximum/minimum level, the handset will beep 3 times.

To redial the last number dialed

Press **[↶]** or **[↷]**, then press **[REDIAL]**.

To redial using the redial list (Memory Redial)

The last 5 phone numbers dialed are stored in the redial list.

1. Press **[REDIAL]**.

- The last number dialed is displayed.

2. Scroll to the desired number by pressing **[▼]** or **[▲]**.

- You can also scroll down through the list by pressing **[REDIAL]**.
- To exit the list, press **[OFF]**.

3. Press **[↶]** or **[↷]**.

- **To erase an item**, scroll to the item then press the soft key **(ERASE)**.
- If "No items stored" is displayed, the list is empty.

To put a call on hold

Press **[HOLD]** during a conversation.

- "Hold" is displayed.

To return to the call, press **[↶]** or **[↷]**.

- If another phone is connected on the same line (p. 9), you can also take the call by lifting its handset.
- If a call is kept on hold for 6 minutes, an alarm tone will start to sound and the Ringer/Message Alert indicator will start to flash rapidly. After 4 additional minutes on hold, the call will be disconnected.

Voice Enhancer Technology

Panasonic's Voice Enhancer Technology clarifies the voice of the person you are talking to, reproducing a more natural-sounding voice that is easier to hear and understand.

Voice Enhancer Technology can be turned on or off. The factory preset is OFF.

- Depending on the condition and quality of your telephone line, this feature may emphasize existing line noise. If it becomes difficult to hear, turn this feature off.

To turn this feature on, press the soft key **(VE)** during a conversation.

- **"VE"** is displayed.
- **To turn this feature off**, press the soft key **(VE)** again. **"VE"** disappears from the display.

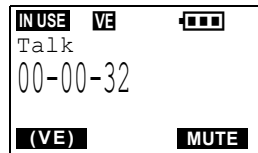

- After hanging up a call, the on/off setting will be retained.

When the handset is not in use, you can also turn this feature on or off by programming as follows:

1. Press **[MENU]**.
2. Scroll to "Voice enhancer" by pressing **[▼]** or **[▲]**, then press the soft key **(SELECT)**.
3. Select "On" or "Off" by pressing **[▼]** or **[▲]**.
4. Press the soft key **(SAVE)**, then press **[OFF]**.

Clarity Booster

This feature can improve sound clarity when the handset is used in an area where there may be interference. During an outside call, this feature will be turned on automatically when necessary. This feature will turn off when you hang up or put a call on hold. It will not turn off automatically during a call. You can also turn this feature on or off manually.

1. Press **[MENU]** during an outside call.
2. Press **[2]** to select "2=Booster on" or "2=Booster off".

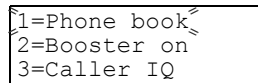

- You can also select "2=Booster on" or "2=Booster off" by pressing **[▼]** then pressing the soft key **(SELECT)**.
- While this feature is turned on, "Booster on" will flash during a conversation.
- If this feature is turned off manually during a call, it will not be turned on automatically during the same call.
- When this feature is turned on automatically or manually, battery operating time may be shortened (p. 11).



Backlit LCD display/Lighted handset keypad

The handset display and dialing buttons will light for a few seconds after pressing a button or lifting the handset off the base unit.

Answering Calls

When a call is received, the unit rings, "Incoming call" is displayed, and the Ringer/Message Alert indicator on the handset and the IN USE indicator on the base unit flash rapidly.

1 Press [] or [].

- You can also answer a call by pressing any button except [, [, or [**OFF**].

2 To hang up, press [**OFF**] or place the handset on the base unit.

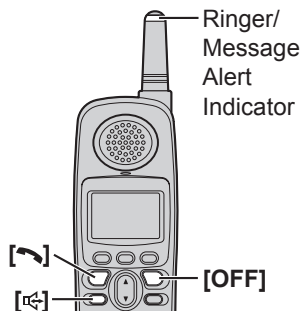

Auto Talk

If the Auto Talk feature is turned on (p. 15), you can answer a call by simply lifting the handset off the base unit.

Temporary ringer off

While the handset is ringing for an outside call, you can turn the ringer off temporarily by pressing [**OFF**]. The handset will ring again as normal the next time a call is received.

- If the ringer volume is turned off, the unit will not ring (p. 16).

Caller ID Service

This unit is compatible with Caller ID services offered by your telephone company. If you subscribe to Caller ID, caller names and phone numbers will be displayed and recorded in the Caller List.

How Caller ID information is displayed

When a call comes in, the unit will ring and Caller ID information will be received. The handset display will show the caller's information.*

Example

ROBINSON, TINA 1-555-222-3333

- After you answer the call, the display will show the length of the call.

*Personalized Name Display

If you receive a call from one of the same phone numbers stored in the phone book, the handset will show the caller's name stored in the phone book instead of incoming caller's name.

- If the unit does not receive Caller ID information, one of the following will be displayed:

Display	Meaning
Out of area	The caller dialed from an area which does not provide Caller ID service.
Private caller	The caller requested not to send his/her information.
Long distance	The caller made a long distance call.

- Depending on radio communications with the base unit, the handset may not display Caller ID information immediately after the first ring.
- If your unit is connected to a PBX which does not support Caller ID, you cannot access Caller ID service.
- Name display service may not be available in some areas. For further information, please contact your telephone company.
- If you subscribe to both Caller ID and Call Waiting with Caller ID service (CWID), when a second call is received while talking, a call waiting tone will be heard and the second caller's information will be displayed (p. 38).
Contact your telephone company for details about availability in your area, and to verify that CWID service is activated on your telephone line.

Using the Caller List

The unit can record information up to 50 different callers and store this information in the Caller List. Caller information is sorted by the most recent call to the oldest. When the 51st call is received, the information from the 1st call is deleted.

The unit will also tell you how many calls you missed while you were out or unavailable to answer the phone.

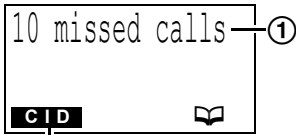

② Stands for Caller ID

- ① The display will show the number of calls you missed.
- ② Press the soft key (**CID**), [**▼**], or [**▲**] to review other calls logged in the Caller List.
 - If there are no items in the Caller List, "**CID**" will not be displayed.
 - After viewing the missed call entries, "missed calls" will disappear from the display.

Viewing the Caller List **Handset**

- 1 Press the soft key (**CID**), [**▼**], or [**▲**] to enter the Caller List.

Ex. 10 calls missed.

```
Caller list
10 missed calls
▼▲=Scroll list
```

- 2 To search from the most recent call, press [**▼**]. To search from the oldest call, press [**▲**].
 - The caller's name, number and the time and date of the call are displayed.

Example

```
SMITH, JACK
1-555-333-4444
3:10P JUN.10
```

- 3 Press [**OFF**] to exit the list.

- If there is no name information for a caller and you do not store the name and phone number in the phone book, the display will only show the phone number.
- If you do not press any buttons for 60 seconds, the unit will exit the Caller List.

Using the Caller List

What “√” means

“√” indicates you have already viewed this calling information or answered the call. If the same caller calls again, the call entry with the “√” will be replaced with the new call entry.

SMITH, JACK 1-555-333-4444 3:10P JUN.10 √

If a caller calls more than once

The number of times the same caller called is displayed (“x2” to “x9”). The date and time of the most recent call will be recorded. After viewing a caller’s information, “x2” to “x9” will be replaced with “√”.

Ex. Called 3 times.

TURNER, CINDY 1-555-456-7890 11:20A JAN.12 x3

Calling Back from the Caller List **Handset**

- 1 Press the soft key (**CID**), [**▼**], or [**▲**] to enter the Caller List.
- 2 Scroll to the desired caller by pressing [**▼**] or [**▲**].
- 3 Press [**↶**] or [**☎**].
 - The phone number is dialed.

- In some cases, you may have to edit the number before dialing (p. 26). (Ex. You may have to delete “1” and the area code.)
- If a phone number is not displayed in the caller information, you cannot call that caller back from the Caller List.

Using the Caller List

Editing the Caller's Phone Number **Handset**

You can edit a phone number in the Caller List by removing its area code and/or the long distance code "1".

Once you call back an edited number, this unit can automatically edit incoming phone numbers from the same area code in the Caller List and each time you receive a call (**Caller ID Number Auto Edit**, p. 27).

1 Press the soft key (**CID**), [**▼**], or [**▲**] to enter the Caller List.

2 Scroll to the desired caller by pressing [**▼**] or [**▲**].

PARKER, FRED
1-555-321-5555

3 Press the soft key (**EDIT**) repeatedly until the number is shown in the desired format.

- Each time you press the soft key (**EDIT**), the number is rearranged into one of 3 patterns.

Ⓐ Phone no.

Ⓑ Area code – Phone no.

Ⓒ 1– Area code – Phone no.

- The order in which patterns Ⓐ–Ⓒ are displayed depends on how the telephone number is displayed in step 2.

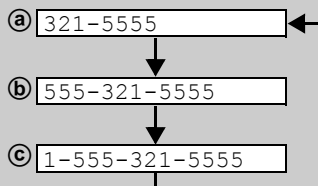

4 To call the edited number, press [**↶**] or [**☎**].

- If Caller ID Number Auto Edit feature is turned on (factory preset is on), phone numbers with the same area code as the number you edited will now be edited in the Caller List and each time you receive a call.
- You can press [**OFF**] immediately after pressing [**↶**] or [**☎**] if you wish to activate the Auto Edit feature without actually dialing the number you just edited.

To save the edited number into the phone book, press the soft key (**SAVE**).

- If there is no name information, see "Storing Caller Information in the Phone Book" on page 28, from step 3.
- Even if the Auto Edit feature is turned on, this feature will not be activated by saving the edited number in the phone book.

- If you receive a call from a 7-digit phone number stored in the phone book, "**EDIT**" will not be displayed when the call's Caller ID information is displayed.

Caller ID Number Auto Edit **Handset**

Once you call back an edited number (p. 26), this unit can automatically edit incoming phone numbers from the same area code in the Caller List and each time you receive a call. For example, it can ignore the area code of calls originating from your area code, so that you can call these numbers from the Caller List without dialing the area code.

To activate this feature, you must edit a caller's phone number in the Caller List (p. 26) by selecting pattern **(a)**, **(b)**, or **(c)**, then make a call to that number. Calls from numbers in that area code will be edited automatically. The unit can remember up to 4 area codes to be edited according to patterns **(a)** and **(b)**.

When more than 5 area codes are edited, older area codes are reset to pattern **(c)**. Phone numbers from the 4 most recently edited area codes will be automatically edited.

You can turn this feature on or off using the handset. The factory preset is ON.

To turn on or off Caller ID Number Auto Edit feature

1 Press [MENU] .	
2 Scroll to "Initial setting" by pressing [▼] or [▲] , then press the soft key (SELECT).	Initial setting
3 Scroll to "Caller ID edit" by pressing [▼] or [▲] , then press the soft key (SELECT).	Caller ID edit
4 Select "Off" or "On" by pressing [▼] or [▲] .	Auto edit :On
5 Press the soft key (SAVE), then press [OFF] .	

- If you fail to reach your destination when making a call, the phone number you dialed might have an incorrect pattern. Edit the phone number with another pattern (p. 26).
- When this feature is turned off, the unit will still be able to display Caller ID, but incoming Caller ID numbers will not be automatically edited.
- If you move to another area you may need to turn this feature off to erase the previously edited area codes. To use this feature again, turn it on and reprogram the area codes you want to be edited once again.

Using the Caller List

Storing Caller Information in the Phone Book **Handset**

Caller names and phone numbers that are in the Caller List can be stored in the phone book.

- 1 Press the soft key (**CID**), [**▼**], or [**▲**] to enter the Caller List.
 - 2 Scroll to the desired caller by pressing [**▼**] or [**▲**].
 - If the number requires editing, see page 26.
 - 3 Press the soft key (**SAVE**).
 - If there is no name information for the caller, "Enter name" will be displayed.
 - You can enter a name by performing the following steps:
 - (1) enter the name (p. 30),
 - (2) press [**▼**], and
 - (3) press the soft key (**SAVE**).
 - If a name is not required, press [**▼**], then press the soft key (**SAVE**).
 - To continue storing other items, repeat from step 2.
 - To exit programming mode, press [**OFF**].
-
- You cannot store Caller List items in the phone book if a phone number is not displayed.

Erasing Caller Information **Handset**

To erase a specific caller

- 1 Press the soft key (**CID**), [**▼**], or [**▲**] to enter the Caller List.
 - 2 Scroll to the desired caller by pressing [**▼**] or [**▲**].
 - 3 Press the soft key (**ERASE**).
 - "Erased" is displayed.
 - To erase other items, repeat from step 2.
 - To exit the Caller List, press [**OFF**].
-

To erase all entries

- 1 Press the soft key (**CID**), [**▼**], or [**▲**] to enter the Caller List.
 - Before erasing all entries, make sure that "0 missed call" is displayed.
 - 2 Press the soft key (**ERASE**).
 - "All erase?" is displayed.
 - To cancel erasing, press the soft key (**NO**).
 - 3 Press the soft key (**YES**).
 - "All erased" is displayed and all entries in your Caller List are erased.
-

Phone Book

The handset can store up to 50 names and phone numbers in its phone book. You can make a call by selecting a name or number from the phone book.

Storing Names and Numbers **Handset**

1 Press the soft key ().

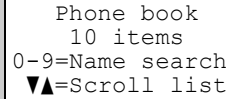

- The display will show the number of stored items.



Phone book
10 items
0-9=Name search
▼▲=Scroll list

2 Press the soft key (**ADD**).

3 Enter a name of up to 16 characters with the dialing buttons ([0] to [9]) (p. 30), then press [▼].

- To move the cursor, press the soft key () or ().
- If a name is not required, press [▼] then go to step 4.

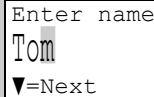

Enter name
Tom
▼=Next

4 Enter a phone number of up to 32 digits.

- To delete a digit, press the soft key (**CLEAR**).
To erase all of the digits, press and hold the soft key (**CLEAR**).

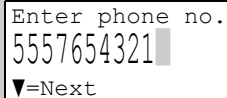

Enter phone no.
5557654321
▼=Next

5 Press [▼].

- If you want to change the name, press the soft key (**EDIT**). The display returns to step 3. Change the name.
- If you want to change the number, press [▲]. The display returns to step 4. Change the number.

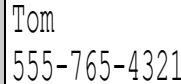

Tom
555-765-4321

6 Press the soft key (**SAVE**).

- To continue storing other items, repeat from step 2.

7 Press [OFF].



- If a pause is required when dialing, press the soft key (**PAUSE**) in step 4. A pause is stored in a phone number as one digit (p. 38).
- To store numbers for calling card access (see “Chain Dial” on page 32), we recommend you add pauses after each item. Storing pauses with numbers will prevent misdialing (p. 38). The delay time necessary will depend on your telephone company.

Phone Book

Selecting characters to enter names

Enter names using the dialing buttons. Press each button until the desired character is displayed.

- Pressing each button selects a character in the order shown below.





Keys	Characters	Keys	Characters
[1]	# & ' () * , - . / 1	[6]	m n o M N O 6
[2]	a b c A B C 2	[7]	p q r s P Q R S 7
[3]	d e f D E F 3	[8]	t u v T U V 8
[4]	g h i G H I 4	[9]	w x y z W X Y Z 9
[5]	j k l J K L 5	[0]	0 Space
	Moves the cursor to the left.		
	Moves the cursor to the right. (To enter another character using the same number key, move the cursor to the next space.)		

For example, to enter “Tom”:

1. Press [8] four times.
2. Press [6] three times, then press the soft key () to move the cursor.
3. Press [6] once.

T
To
Tom

If you make a mistake while entering a name or number

1. Press the soft key () or () to move the cursor to the incorrect character.
2. Press the soft key () to delete the character.
 - Each time you press the soft key (), a character is erased.
 - To erase all characters, press and hold the soft key ().
3. Enter the correct character.

Dialing from the Phone Book **Handset**

1 Press the soft key (☰).

- The display shows the number of stored items.
- You can press the soft key (**SEARCH**) to view the first item.

Phone book
10 items
0-9=Name search
▼▲=Scroll list

2 Scroll to the desired item. To scroll down, press [▼]. To scroll up, press [▲].

Phone book items are sorted in the following order:

1	Alphabet letters (Alphabetical)
2	Space & ' () , - . /
3	Numbers 0 to 9
4	# *
5	Telephone numbers (If no name is stored)

Frank
555-456-7890

3 Press [↶], [↷], or the soft key (**CALL**).

- The phone number is dialed.

- If “No items stored” is displayed in step 1, the phone book is empty.
- To exit the phone book, press **[OFF]**.

To search for a name by initial

1. Press the soft key (☰).

2. Press the dialing button for the first letter of the desired name until any name with the same initial is displayed (see the Index table below).

Ex. To find “Frank”, press **[3]** repeatedly until the first item under “F” is displayed.

- If there are no items beginning with the character you selected, the first item in the next alphabetical index will be displayed.

3. Press [▼] repeatedly until the desired name is displayed.

Index table

Keys	Index	Keys	Index
[1]	Symbols, 1	[6]	M, N, O, 6
[2]	A, B, C, 2	[7]	P, Q, R, S, 7
[3]	D, E, F, 3	[8]	T, U, V, 8
[4]	G, H, I, 4	[9]	W, X, Y, Z, 9
[5]	J, K, L, 5	[0]	0, Space

Phone Book

Chain Dial **Handset**

You can dial a combination of phone book or manual key pad entries while making a call. This feature can be used, for example, to first automatically dial a calling card access number that you have stored in the phone book, then manually or automatically dial your PIN and then automatically dial the destination from the phone book.

Ex. Using a long distance calling card

- To prevent misdialing, we recommend you add pauses where needed when storing numbers. For example, add pauses after a calling card access number and your PIN when storing in the phone book (p. 29).

1. Search and dial from the phone book: 1-800-012-3456 (Calling card access number)
 - The voice guidance will be announced.
2. Search and dial from the phone book: 1234 (Calling card PIN)
3. Search and dial from the phone book: 1-555-012-3456 (Destination Number)

- 1 While you are on a call;**
Press **[MENU]**.

1=Phone book
2=Booster on
3=Caller IQ

- 2 Press the soft key (**SELECT**) at “1=Phone book”, or press **[1]**.**

Phone book
30 items
0-9=Name search
▼▲=Scroll list



- 3 Search for the desired item by pressing **[▼]** or **[▲]**.**
- To search for an item by initial, see page 31.

Alan
1-555-012-3456

- 4 Press the soft key (**CALL**).**
- The phone number is dialed.
 - If required, repeat steps 1 to 4 for any remaining numbers.

- If you have rotary or pulse service, you need to press **[*]** before pressing **[MENU]** in step 1 to change the dialing mode temporarily to tone.

Editing an Item in the Phone Book **Handset**

<p>1 Press the soft key (.</p>	
<p>2 Scroll to the desired item by pressing [▼] or [▲].</p> <ul style="list-style-type: none"> To search for the item by initial, see page 31. 	<div style="border: 1px solid black; padding: 5px;"> <p>Jane 456-7890</p> </div>
<p>3 Press the soft key (EDIT).</p>	<div style="border: 1px solid black; padding: 5px;"> <p>Enter name Jane ▼=Next</p> </div>
<p>4 Edit the name (p. 30), then press [▼].</p> <ul style="list-style-type: none"> If you do not need to change the name, press [▼] then go to step 5. To move the cursor, press the soft key () or (. 	<div style="border: 1px solid black; padding: 5px;"> <p>Enter name Jane Walker ▼=Next</p> </div>
<p>5 Edit the phone number, then press [▼].</p> <ul style="list-style-type: none"> If you do not need to change the number, press [▼] then go to step 6. To delete a digit, press the soft key (CLEAR). To delete all of the digits, press and hold the soft key (CLEAR). 	<div style="border: 1px solid black; padding: 5px;"> <p>Enter phone no. 5554567890 ▼=Next</p> </div>
<p>6 Press the soft key (SAVE).</p> <ul style="list-style-type: none"> To continue editing other items, repeat from step 2. 	
<p>7 Press [OFF].</p>	

Erasing an Item in the Phone Book **Handset**

<p>1 Press the soft key (.</p>	
<p>2 Scroll to the desired item by pressing [▼] or [▲].</p> <ul style="list-style-type: none"> To search for the item by initial, see page 31. 	
<p>3 Press the soft key (ERASE).</p> <ul style="list-style-type: none"> To cancel erasing, press the soft key (NO). 	<div style="border: 1px solid black; padding: 5px;"> <p>Erase?</p> </div>
<p>4 Press the soft key (YES).</p> <ul style="list-style-type: none"> To erase other items, repeat from step 2. 	<div style="border: 1px solid black; padding: 5px;"> <p>Erased</p> </div>
<p>5 Press [OFF].</p>	

Voice Mail Service

Voice mail is an automatic answering service offered by your telephone company. If you subscribe to this service, your telephone company's voice mail system can answer calls for you when you are unavailable to answer the phone or when your line is busy. Callers can leave messages that are saved in virtual voice mailboxes, which are maintained for you at the phone company, allowing you to listen to your messages whenever you like.

The unit will let you know that someone has left voice mail for you (p. 36).

Once you have stored your voice mail access number, you can access your voice mailbox simply by pressing the soft key (**VM**), then pressing [**↶**] or [**↷**] on the handset.

Storing a Voice Mail Access Number **Handset**

1 Press [**MENU**].

2 Scroll to "Initial setting" by pressing [**▼**] or [**▲**], then press the soft key (**SELECT**).

Initial setting

3 Press the soft key (**SELECT**) at "Voice Mail".

Voice Mail

4 Press the soft key (**SELECT**) at "Store VM access#".

Store VM access#

5 Enter your access number, up to 32 digits.

- If a pause is required for dialing, press the soft key (**PAUSE**).*
- Each time you press the soft key (**CLEAR**), a digit is erased. To erase all of the digits, press and hold the soft key (**CLEAR**).

Example

Store VM access#
1234567PPP890

6 Press the soft key (**SAVE**), then press [**OFF**].

- "**VM**" is displayed.

*To prevent misdialing, you may add pauses between your voice mail access number and your mailbox password in step 5.

Ex. 1-222-333-4444 PPPP 8888

Your voice mail access number Pauses Your mailbox password

Pressing the soft key (**PAUSE**) once creates a 3.5 second delay and counts as one digit. The delay time necessary between entering your access number and entering your mailbox password will depend on your telephone company.

To erase a stored voice mail access number

Repeat steps 1 to 4 on page 34, then press and hold the soft key (**CLEAR**) until all of the digits are erased. Press the soft key (**SAVE**), then press **[OFF]**.

Setting Voice Mail (VM) Tone Detection **Handset**

Your telephone company sends special signals (Voice mail tones) to the unit. Press **[📞]** or **[📞]** to listen to the dial tone. If you hear a series of dial tones followed by a continuous dial tone, this indicates that a new message was recorded. Voice Mail detection is preset at the factory to ON. Minutes after you hang up or after the phone stops ringing, your unit will seize the phone line and check if a message has been recorded. If a new message was recorded at your telephone company, "Voice Mail" will be displayed on the handset, the Ringer/Message Alert indicator on the handset will flash slowly if Message Alert is turned on (p. 18), and the VM indicator will flash on the base unit.

Turn off this programming when:

- you do not subscribe to a voice mail service,
- your telephone company does not send a series of tones, followed by a continuous tone to indicate you have new voice mail, or
- your phone is connected to a business or office telephone system (PBX).

See below to turn this setting off.

If you are not sure which setting is required, consult your local telephone company or contact the Panasonic Customer Call Center.

1 Press [MENU] .	
2 Scroll to "Initial setting" by pressing [▼] or [▲] , then press the soft key (SELECT).	Initial setting
3 Press the soft key (SELECT) at "Voice Mail".	Voice Mail
4 Scroll to "VM tone detect" by pressing [▼] or [▲] , then press the soft key (SELECT).	VM tone detect
5 Select "Off" or "On" by pressing [▼] or [▲] .	VM tone detect :On
6 Press the soft key (SAVE), then press [OFF] .	



Voice Mail Service

Listening to Voice Mail Messages **Handset**

The unit will let you know that someone has left new voice mail for you:

- (a) the VM indicator will flash on the base unit,
- (b) "Voice Mail" will be displayed on the handset,
- (c) "**VM**" will flash on the handset, and
- (d) the Ringer/Message Alert indicator on the handset will flash slowly if Message Alert is turned on (p. 18) and the handset is not in use.

To listen to your voice mail message(s)

1 Press the soft key (**VM**), then press [] or [.

- "Dial VM access#" is displayed and the number is dialed (p. 34).
- If the handset beeps 3 times and "Store VM access#" is displayed, a voice mail access number is not stored. To store the number, see page 34.



2 Follow the pre-recorded instructions.

3 When finished, press [**OFF**].

- After listening to your message(s), "**VM**" stops flashing but remains on the handset display.
- If the handset and base unit still indicate you have new messages even after you have listened to them, turn the voice mail indicators off by pressing and holding [**OFF**] until the handset beeps. "Voice Mail" will disappear and "**VM**" stops flashing but remains on the handset, and the Ringer/Message Alert indicator on the handset and the VM indicator on the base unit will go out.
- If your voice mail service uses a voice mail tone and the recorded message is over 3 minutes long, the handset and base unit may not indicate you have new messages.
- If your voice mail service uses a voice mail tone, the tone will be heard from any parallel connected phone. If you use another phone to retrieve messages, you have to dial your access number manually.

Special Features

Handset Locator **Base Unit**

You can locate the handset or page the handset user with beep tones from the base unit.

1 Press **[LOCATOR]** to page the handset.

- The IN USE indicator on the base unit and the Ringer/Message Alert indicator on the handset flash rapidly.
- The paged handset will ring for 1 minute and display "Call from Base".

2 To stop paging,

Base unit:

Press **[LOCATOR]**.

OR

Handset:

Press **[OFF]**.

- You can also stop paging by pressing any button except **[▼]** or **[▲]**.

Muting Your Conversation **Handset**

During a call, you can mute your phone so the other party cannot listen to you. When muting your conversation, you can hear the other party.

Press the soft key (**MUTE**).

- "Mute" will be displayed for a few seconds and "**MUTE**" will flash.
- **To release the mute**, press the soft key (**MUTE**) again.
- If you press **[↶]** or **[↷]** to switch between the receiver and speaker, the mute will be released.

Temporary Tone Dialing

(For Rotary or Pulse Service Users) **Handset**

Press **[*]** (TONE) before entering access numbers which require tone dialing.

- The dialing mode changes to tone. You can enter numbers to access an answering service, electronic banking service, etc. When you hang up, the dialing mode will return to pulse.

Special Features

For Call Waiting Service Users **Handset**

Press **[FLASH/CALL WAIT]** if you hear a call waiting tone during a conversation.

- The first call is put on hold and you can answer the second call.
- To return to the first caller, press **[FLASH/CALL WAIT]** again.
- Call Waiting service cannot be used when the first call is put on hold.
- If this function does not operate properly, consult your telephone company for details.

Call Waiting Caller ID display **Handset**

If you subscribe to both Caller ID and Call Waiting with Caller ID services (CWID), when a second call is received while talking, the second caller's information will be displayed. After you hear a call waiting tone while talking, the display shows the caller's name with the phone number and "Waiting".

BROWN, NANCY
1-555-666-7777
----Waiting-----

- Contact your telephone company for details about availability in your area, and to verify that CWID service is activated on your telephone line.

Using the PAUSE Button (For PBX Line/Long Distance Calls)

Handset

We recommend you press the soft key (**PAUSE**) if a pause is required for dialing with a PBX or to make a long distance call.

- "**PAUSE**" is displayed on the handset only when dialing before pressing [**↶**] or [**☎**] (p. 20), or storing numbers in the phone book (p. 29).

Ex. Line access number **[9]** (PBX)

[9] ➡ Soft key (**PAUSE**) ➡

Phone number

- Pressing the soft key (**PAUSE**) once creates a 3.5 second pause. This prevents misdialing when you dial after confirming the entered number (p. 20) or dial a stored number (p. 31, 32).
- Pressing the soft key (**PAUSE**) more than once increases the length of the pause between numbers.

FLASH Button **Handset**

Pressing **[FLASH/CALL WAIT]** allows you to use special features of your host PBX such as transferring an extension call, or accessing optional telephone services such as call waiting.

- Pressing **[FLASH/CALL WAIT]** cancels the mute or the Temporary Tone Dialing mode (p. 37).

Selecting the flash time

The flash time depends on your telephone exchange or host PBX.

You can select the following flash times: “700, 600, 400, 300, 250, 110, 100 or 90 ms (milliseconds)”. The factory preset is “700 ms”.

- If PBX functions do not work correctly, consult your PBX supplier for the correct settings.

<p>1 Press [MENU].</p>	
<p>2 Scroll to “Initial setting” by pressing [▼] or [▲], then press the soft key (SELECT).</p>	<div style="border: 1px solid black; padding: 5px; text-align: center;">Initial setting</div>
<p>3 Scroll to “Set tel line” by pressing [▼] or [▲], then press the soft key (SELECT).</p>	<div style="border: 1px solid black; padding: 5px; text-align: center;">Set tel line</div>
<p>4 Scroll to “Set flash time” by pressing [▼] or [▲], then press the soft key (SELECT).</p>	<div style="border: 1px solid black; padding: 5px; text-align: center;">Set flash time</div>
<p>5 Select the flash time by pressing [▼] or [▲].</p>	<div style="border: 1px solid black; padding: 5px; text-align: center;">Set flash time :700ms</div>
<p>6 Press the soft key (SAVE), then press [OFF].</p>	

Special Features

Key Tone **Handset**

You can select whether or not the handset keys will sound tones (key tone, confirmation tone, error tone). The factory preset is ON.

1 Press **[MENU]**.

2 Scroll to “Initial setting” by pressing **[▼]** or **[▲]**, then press the soft key **(SELECT)**.

Initial setting

3 Scroll to “Key tone” by pressing **[▼]** or **[▲]**, then press the soft key **(SELECT)**.

Key tone

4 Select “Off” or “On” by pressing **[▼]** or **[▲]**.

Key tone
:On

5 Press the soft key **(SAVE)**, then press **[OFF]**.

Re-registering the Handset **Handset & Base Unit**

If “No link to base. Move closer to base and try again.” is displayed even when using the handset near the base unit, the handset may have lost communication with the base unit. You need to re-register the handset to that base unit.

- Have both the handset and base unit nearby during registration.
- Follow steps 1 and 2 listed below. You have about 1 minute to complete them.

1 *Base unit:* Press and hold **[LOCATOR]** for 3 seconds.

- The CHARGE indicator flashes.

2 Handset: Press and hold **[FLASH/CALL WAIT]** until “Handset Registering” is displayed.

- After registration is complete, a long beep sounds from the handset.

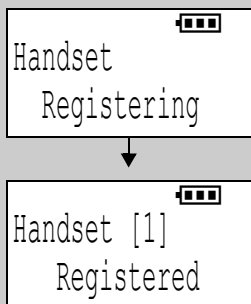

- If the handset beeps 3 times and “Error!!” is displayed, an error occurred. Try again from step 1.
- You can stop registration by pressing **[OFF]** on the handset and pressing **[LOCATOR]** on the base unit.

Belt Clip

You can hang the handset on your belt or pocket using the included belt clip.

To attach the belt clip

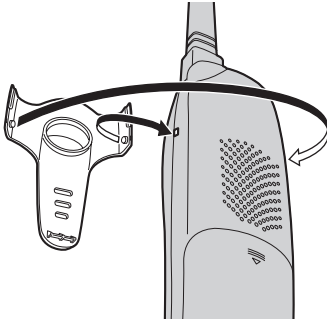

To remove the belt clip

While pressing the top of the clip (A), pull the right edge in the direction of the arrow (B).

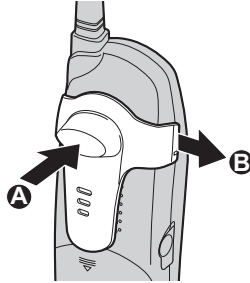

Optional Headset

Connecting an optional headset to the handset allows hands-free phone conversation. Please use only a Panasonic KX-TCA60, KX-TCA86, KX-TCA88, KX-TCA88HA, KX-TCA91, KX-TCA92, or KX-TCA98 headset. To order, call the accessories telephone number on page 2.

Connecting an optional headset

Open the headset jack cover, and insert the headset plug into the headset jack as shown below.

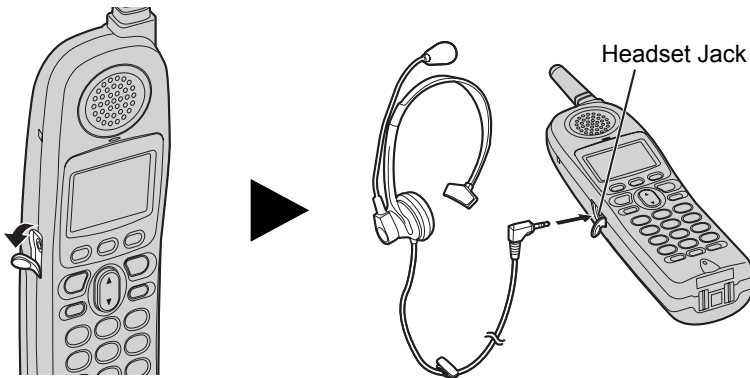

- Headset sold separately. Model shown here is KX-TCA88.

To switch to the speakerphone while using the headset:

Press [M]. To return to the headset, press [R].

Wall Mounting

This unit can be mounted on a wall phone plate.

- 1 Connect the AC adaptor.

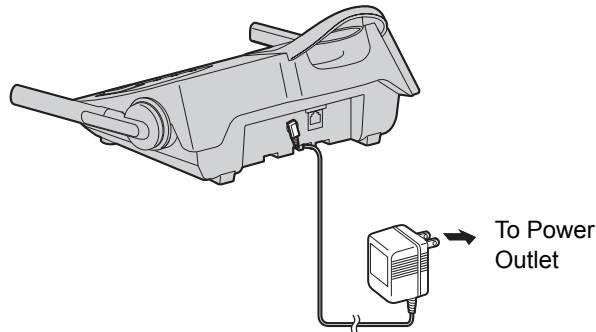

- 2 Tuck the telephone line cord inside the wall mounting adaptor (1).
Connect the telephone line cord (2).

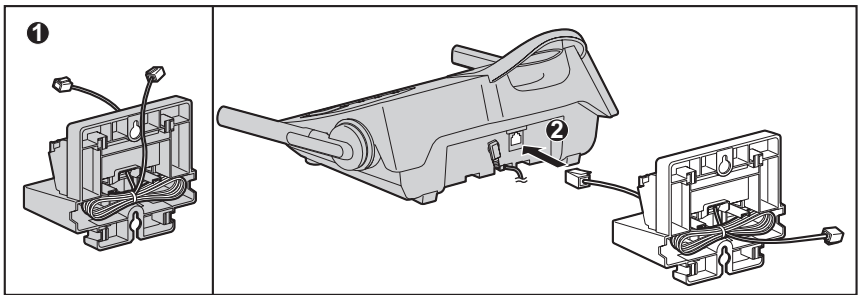

- 3 Insert the hooks on the wall mounting adaptor into the holes (A) and (B) on the base unit.

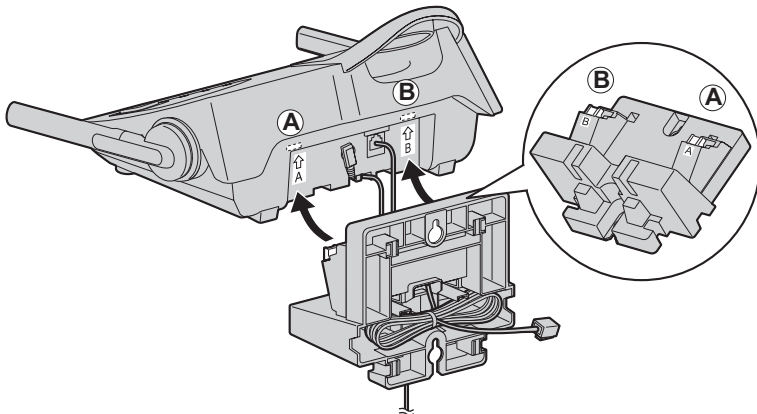

Wall Mounting

- 4** Adjust the adaptor to hold the base unit, then push it in the direction of the arrow until it clicks into place.

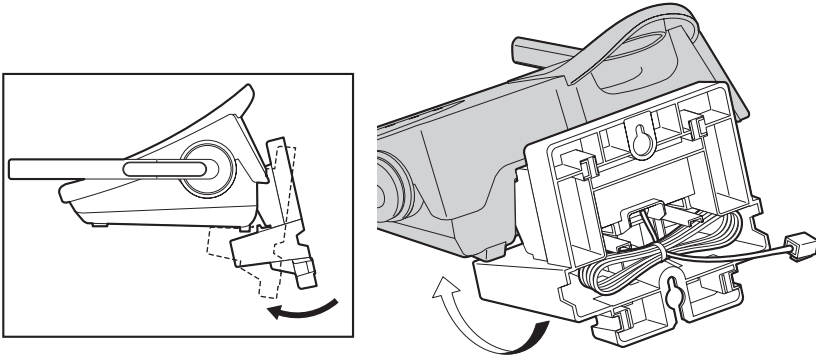

- 5** Connect the telephone line cord. Mount the unit, then slide it down.
• Raise the antennas.

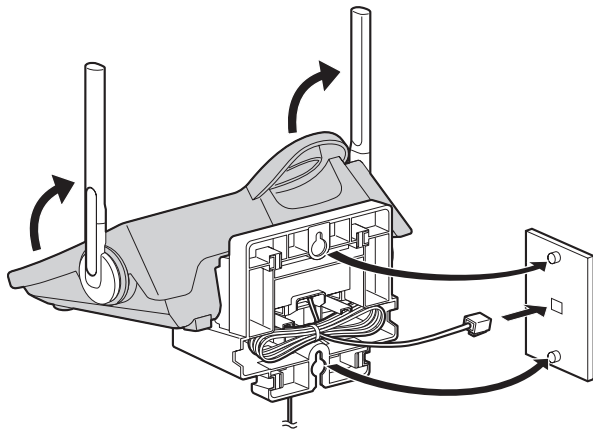

- 6 To charge the handset battery:**
Place the handset on the base unit.
• The unit beeps once and the CHARGE indicator lights.

Wall Mounting

To remove the wall mounting adaptor

While pushing down the RELEASE LEVERS (❶), remove the adaptor (❷).

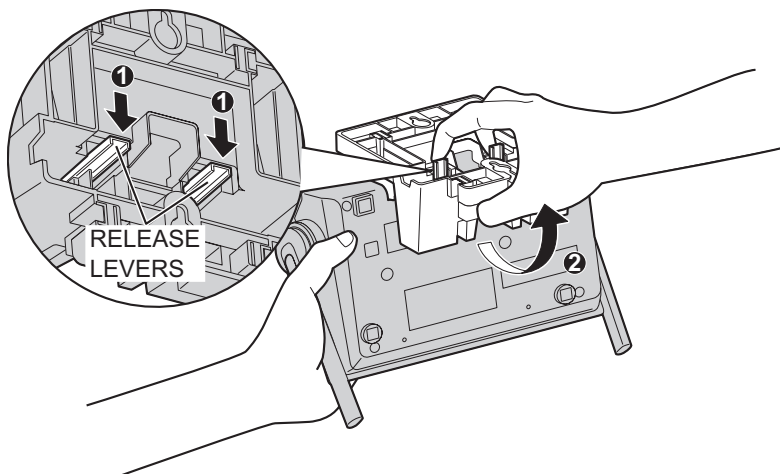

Direct Commands

Handset

After pressing [MENU], you can also program menu items directly by pressing ([0] to [9], and [#]) instead of using the soft keys.

Menu item	Command	Selection items	Page
Ringer volume	[1] [1]	[0] : Off [1] : Low [2] : Medium [3] : High	p. 16
Ringer tone	[1] [2]	[1]–[3] : Tone pattern 1–3 [4]–[7] : Melody pattern 1–4 [8]–[9] : Downloaded melody pattern 1–2 *1	p. 17
Voice enhancer	[5]	[1] : On [0] : Off	p. 21
Activate Caller IQ *2	[7] [1]		–
View information *4	[7] [2] *5	Go to Step 4 on page 54.	–
Get new information *3	[7] [3] *5	Go to Step 4 on page 53.	–
Turn Caller IQ off *3	[7] [4] *5		p. 51
Turn Caller IQ on *3	[7] [5] *5		p. 51
LCD contrast	[0] [1]	[1]–[6] : Level 1–6	p. 18
Key tone	[0] [2]	[1] : On [0] : Off	p. 40
Auto talk	[0] [3]	[1] : On [0] : Off	p. 15
Caller ID Number Auto Edit	[0] [4]	[1] : On [0] : Off	p. 27
Set dial mode	[0] [5] [1]	[1] : Pulse [2] : Tone	p. 14
Set flash time	[0] [5] [2]	[1] : 700 ms [2] : 600 ms [3] : 400 ms [4] : 300 ms [5] : 250 ms [6] : 110 ms [7] : 100 ms [8] : 90 ms	p. 39
Set line mode	[0] [5] [3]	[1] : A [2] : B	p. 15
Store VM access#	[0] [7] [1]	Go to Step 5 on page 34.	–
VM tone detect	[0] [7] [2]	[1] : On [0] : Off	p. 35
Change language	[0] [8]	[1] : English [2] : Spanish	p. 14
Message alert	[0] [#]	[1] : On [0] : Off	p. 18

Direct Commands

During programming:

When “**SAVE**” is displayed, press the right soft key to **save the new settings**.

To exit programming, press **[OFF]**.

- If you press the direct command incorrectly, press **[OFF]**, then re-enter programming mode by pressing **[MENU]**.
- For function details, see the corresponding pages.

*¹You need to first download melody data from the openLCR web site.

*²This feature can be used to activate Caller IQ. See the leaflet included with this unit for more information.

*³For openLCR subscribers only.

*⁴For openLCR subscribers only. If information is not downloaded to your unit, “Get new Info.?” will be displayed. To download information, see page 53.

*⁵After pressing **[7]**, make sure “View Info.?” is displayed, then press the next command. If Caller IQ is turned off, “Turn CIQ on?” is displayed after pressing **[7]**.

If the Following Appear on Your Display...

The following will be displayed when the unit needs your attention.

Display message	Cause & Remedy
Recharge battery	<ul style="list-style-type: none">• The battery needs to be charged. Recharge the battery (p. 11).
Charge for 6 HRS	<ul style="list-style-type: none">• The battery has been discharged. The handset will not work. Fully charge the battery (p. 10).
No link to base. Move closer to base and try again.	<ul style="list-style-type: none">• The handset has lost communication with the base unit. Walk closer to the base unit and try again or re-register the handset (p. 40).• Confirm the base unit's AC adaptor is plugged in.• Raise the base unit antennas.
Please lift up and try again.	<ul style="list-style-type: none">• A handset button was pressed while the handset was on the base unit. Lift the handset and press the button again.
Error!!	<ul style="list-style-type: none">• When you tried to re-register the handset, the handset and base unit could not link for some reason, such as interference from electrical appliances. Move the handset and base unit away from any electrical appliances and try again.
Phone book full	<ul style="list-style-type: none">• When you tried to store an item in the phone book, the phone book memory was full. Press [OFF] to exit programming mode. To erase other items from the phone book, see page 33.
Store VM access#	<ul style="list-style-type: none">• A voice mail access number is not stored. Store the number (p. 34).
System is busy. Please try again later.	<ul style="list-style-type: none">• The handset has lost communication with the base unit. Walk closer to the base unit and try again.

Troubleshooting

If the handset display shows error messages, see “If the Following Appear on Your Display...” (p. 47) for the Cause & Remedy.

Problem	Cause & Remedy
“No link to base. Move closer to base and try again.” is displayed and an alarm tone sounds.	<ul style="list-style-type: none">• You are too far from the base unit. Walk closer to the base unit, and try again.• Confirm the base unit’s AC adaptor is plugged in.• Raise the base unit antennas.• If the above remedies do not solve the problem, the handset may have lost communication with the base unit. Register the handset again (p. 40).
The handset and/or base unit does not work.	<ul style="list-style-type: none">• Check the settings (p. 9–11).• Check whether the dialing mode setting is correct (p. 14).• Fully charge the battery (p. 10).• Clean the charge contacts and charge again (p. 11).• Check battery installation (p. 10).• Unplug the base unit’s AC adaptor to reset it. Plug in, and try again.• Re-install the battery (p. 10) and fully charge it.
Static, sound cuts in/out, fades. Interference from other electrical units.	<ul style="list-style-type: none">• Move the handset and base unit away from other electrical appliances (p. 3).• Walk closer to the base unit.• Raise the base unit antennas.• Turn on the Clarity Booster feature (p. 21).
The handset does not ring.	<ul style="list-style-type: none">• The ringer volume is turned off. Set to high, medium, or low (p. 16).
The handset display is blank.	<ul style="list-style-type: none">• If the handset display is blank, fully charge the battery (p. 10).
You cannot program any function items.	<ul style="list-style-type: none">• Programming is not possible while the handset is being used.• Do not pause for over 60 seconds while programming.• Walk closer to the base unit.
While programming or searching, the handset starts to ring and the program/search stops.	<ul style="list-style-type: none">• A call is coming in. To answer the call, press [📞] or [📞]. Start again from the beginning after hanging up.

Troubleshooting

Problem	Cause & Remedy
You cannot redial.	<ul style="list-style-type: none"> If the last number dialed was more than 48 digits long, the number will not be redialed correctly.
You cannot make long distance calls.	<ul style="list-style-type: none"> Please make sure you have long distance service. Check if Caller IQ is on. Turn Caller IQ off (p. 51).
The handset does not display the caller's name and/or phone number.	<ul style="list-style-type: none"> You need to subscribe to Caller ID. Other telephone equipment may be interfering with your phone. Disconnect it and try again. Other electrical appliances connected to the same outlet may be interfering with Caller ID. Telephone line noise may be affecting Caller ID. The caller requested not to send his/her Caller ID information (p. 23). If a (separate) Caller ID box is connected between the base unit and the telephone wall jack, disconnect the Caller ID box or plug the unit directly into the wall jack.
The handset cannot automatically edit the Caller List/incoming phone numbers.	<ul style="list-style-type: none"> The Caller ID Number Auto Edit feature is turned off. Turn it on (p. 27) and try again. You need to press [↶] or [↷] after editing the number.
The handset display exits the Caller List or phone book.	<ul style="list-style-type: none"> Do not pause for over 60 seconds while searching.
"Recharge battery" is displayed, "▣" flashes, or the handset beeps intermittently.	<ul style="list-style-type: none"> Fully charge the battery (p. 10).
"Charge for 6 HRS" and "▣" are displayed and the handset does not work.	<ul style="list-style-type: none"> The battery has been discharged. Fully charge the battery (p. 11).
You charged the battery fully, but "Recharge battery" is still displayed and/or "▣" continues to flash, or "Charge for 6 HRS" and "▣" are displayed.	<ul style="list-style-type: none"> Clean the charge contacts and charge again (p. 11). The battery may need to be replaced. If you install a new battery, fully charge it (p. 10, 11).

Troubleshooting

Problem	Cause & Remedy
The CHARGE indicator does not go out after the battery has been charged.	<ul style="list-style-type: none">• This is normal.
The Ringer/Message Alert indicator flashes slowly when the handset is not ringing and in use.	<ul style="list-style-type: none">• The Message Alert is turned on and new messages in your voice mailbox have been recorded. Turn the Message Alert off (p. 18) or listen to the new messages (p. 36).
You cannot have a conversation using the headset.	<ul style="list-style-type: none">• Make sure the optional headset is connected properly (p. 41).• If “SP-phone” is displayed on the handset, press [>] to switch to the headset.
If you cannot solve your problem	<ul style="list-style-type: none">• Visit our website: http://www.panasonic.com/support• Contact us via the web at: http://www.panasonic.com/contactinfo• Call our customer call center at: 1-800-211-PANA(7262)

openLCR service for Caller IQ

Problem	Cause & Remedy
When you try to download the data from openLCR, the voice prompt is not announced from the handset while “Listen & follow phone guidance.” is being displayed.	<ul style="list-style-type: none">• Check the settings (p. 9–11).• Dialing to openLCR may have been disconnected. Try again (p. 53).• If you cannot solve a problem, consult openLCR (see below).
For more information about Caller IQ	<ul style="list-style-type: none">• Call openLCR’s customer service department at 1-866-openLCR(1-866-673-6527).• openLCR’s web site: www.openLCR.com

openLCR Service for Caller IQ

The unit is compatible with services provided by openLCR.

Important:

- If you have any questions regarding the openLCR service, call openLCR's customer service department at 1-866-openLCR(1-866-673-6527).
- NEITHER PANASONIC COMMUNICATIONS CO., LTD. (PCC) NOR MATSUSHITA ELECTRIC CORPORATION OF AMERICA (MECA) IS IN ANY WAY AFFILIATED WITH, OR RESPONSIBLE FOR THE ACTS OR OMISSIONS OF, OPENLCR.COM, INC. (OPENLCR). NEITHER PCC NOR MECA NOR ANY OF THEIR EMPLOYEES OR AFFILIATES OR CUSTOMERS MAKE ANY WARRANTIES OR REPRESENTATIONS, EITHER EXPRESS OR IMPLIED, TO ANY CUSTOMER OR ANY OTHER THIRD PARTY WITH RESPECT TO ANY OF THE SERVICES PROVIDED BY OPENLCR, NOR ASSUME NOR CREATE ANY OTHER OBLIGATION OF ANY KIND ON BEHALF OF OPENLCR.

Turning on or off Caller IQ Feature **Handset**

After the first download to your phone, Caller IQ features are automatically turned on. If you wish, you can turn off Caller IQ.

- When Caller IQ is on, “[CIQ]” is displayed while talking.

To turn off Caller IQ feature (when it is already on.)

1 Press **[MENU]**.

2 Scroll to “Caller IQ” by pressing **[▼]** or **[▲]**, then press the soft key (**SELECT**).

Caller IQ

3 Scroll to “Turn CIQ off?” by pressing **[▼]** or **[▲]**, then press the soft key (**YES**).

Turn CIQ off?

- “Caller IQ off” is displayed.

4 Press **[OFF]**.

To turn on Caller IQ feature (after it was turned off)

1 Follow steps 1 to 2 of “To turn off Caller IQ feature” above.

2 Press the soft key (**YES**) at “Turn CIQ on?”.

Turn CIQ on?

- “Caller IQ on” is displayed.

3 Press **[OFF]**.

openLCR Service for Caller IQ

Downloading Data

You can download the following data to your unit from the openLCR web site.

- Phone book data
- Ringer melodies (Custom ringtone)
- Function setup for your unit
- Information such as weather forecasts, stock quotes, lottery results, sports scores and horoscopes (Internet content)

Accessing the openLCR web site can be done from any computer with Internet access.

To create data on the openLCR web site

1 Access the openLCR's web site at **www.openLCR.com** and click on the "Manage Account/Login" tab.

2 Enter your Telephone Number and Password, then click .

3 Follow the on-screen instructions.

Phone book data:

- To create the phone book data, enter a name of up to 16 characters, and a phone number of up to 32 digits.
- If you have already stored items into the phone book of the unit, you need to enter all of those stored items again using the openLCR web site. Then add all new items through the openLCR web site.

Ringer melodies:

- The unit stores up to 2 ringer melodies in the handset and you can select up to 2 ringer melodies as ringer tone (p. 45, 54).

Function setup:

- See openLCR's web site for function items available for download.

Information:

- You can select the information which you want to show on the handset display.
-

- If you have stored items in the phone book of the unit, you also need to store those items on the web site.
- The description on the openLCR web screen is subject to change without notice.

To download data from openLCR **Handset**

Each time you download data (p. 52) from openLCR, the information stored in your unit will be updated. To view up-to-date information, you will need to download it to your unit.

- You can select the items of information on the web site which you want to view.
- Horoscopes are for entertainment purposes only.

1 Press **[MENU]**.

2 Scroll to “Caller IQ” by pressing **[▼]** or **[▲]**, then press the soft key (**SELECT**).

3 Scroll to “Get new Info.?” by pressing **[▼]** or **[▲]**, then press the soft key (**YES**).

- The unit will dial openLCR automatically.
- A voice prompt will be heard.

If you live in or move from another area to Fort Collins, Colorado, press **[#]** before pressing the soft key (**YES**).

Get new Info.?



Listen & follow phone guidance.

4 Follow the voice prompt to start downloading.

- If you have rotary or pulse service, you need to press **[*]** to change the dialing mode temporarily to tone, before following the voice prompt.
- When downloading starts, the display will show the message on the right.
- After downloading starts, the handset must be off-hook. DO NOT PLACE the handset on the base unit. Placing the handset on the base unit will terminate the download process. DO NOT PRESS **[OFF]** (pressing **[OFF]** will terminate the download process).

Download in process.
Please wait.

5 When downloading is complete, a beep sounds.

【Caller IQ on】
Download OK!

• You can also go to the Caller IQ menu after pressing **[☰]** or **[☰]**. Press **[MENU]**, then **[3]** to select “3=Caller IQ”. Follow steps 3 to 5 above.

• If the handset beeps 3 times and the following is displayed, the unit has lost communication with openLCR. Store items by following the steps below.

Download incomplete.
Try again.

1. Access the openLCR web site.

2. Go to the web screen to create the data.

- To download the phone book data, click **[Re-Download All]**. Then go to step 3.

3. Start again from step 1 (“To download data from openLCR”).

openLCR Service for Caller IQ

- If the handset beeps 3 times and the following is displayed, some items could not be stored in the phone book. Store items by following the steps below.

Download incomplete.
Phone book full.

 1. Erase items which do not exist on the web from the phone book of the unit (p. 33).
 2. Access the openLCR web site.
 3. Go to the web screen to create the phone book data.
 4. Click Re-Download All.
 5. Start again from step 1 (“To download data from openLCR” on page 53).
- You cannot access the openLCR server if a telephone or fax machine on the same phone line is in use simultaneously.
- While the unit is downloading data from openLCR, the Call Waiting Service cannot be used.

To use downloaded melodies as the ringer tone

The melody(ies) you download from openLCR are stored in the handset and will be heard when you receive an outside call. The names of each melody (up to 14 characters) are also downloaded.

To select the desired melody, go to the Ringer tone menu in the Ringer setting menu (p. 17). Downloaded melody 1 and 2 can also be selected by pressing [▼], [▲], [8] or [9].

To view information

1 Press [MENU].

2 Scroll to “Caller IQ” by pressing [▼] or [▲], then press the soft key (SELECT).

Caller IQ

3 Press the soft key (YES) at “View Info.?”.

View Info.?

- The items of information which you selected on the web are displayed.
- If information is not downloaded to your unit, “Get new Info.?” will be displayed. To download information, see page 53.

4 Scroll to the desired information by pressing [▼] or [▲].

- You can also select the desired information by pressing dialing buttons.

5 When finished, press [OFF] or place the handset on the base unit.

Important Safety Instructions

When using this unit, basic safety precautions should always be followed to reduce the risk of fire, electric shock, or personal injury.

1. Read and understand all instructions.
2. Follow all warnings and instructions marked on this unit.
3. Unplug this unit from AC outlets before cleaning. Do not use liquid or aerosol cleaners. Use a damp cloth for cleaning.
4. Do not use this unit near water, for example, near a bathtub, washbowl, kitchen sink, or the like.
5. Place this unit securely on a stable surface. Serious damage and/or injury may result if the unit falls.
6. Do not cover slots and openings on the unit. They are provided for ventilation and protection against overheating. Never place the unit near radiators, or in a place where proper ventilation is not provided.
7. Use only the power source marked on the unit. If you are not sure of the type of power supplied to your home, consult your dealer or local power company.
8. Do not place objects on the power cord. Install the unit where no one can step or trip on the cord.
9. Do not overload wall outlets and extension cords. This can result in the risk of fire or electric shock.
10. Never push any objects through slots in this unit. This may result in the risk of fire or electric shock. Never spill any liquid on the unit.
11. To reduce the risk of electric shock, do not disassemble this unit. Take the unit to an authorized servicer when service is required. Opening or removing covers may expose you to dangerous voltages or other risks. Incorrect reassembly can cause electric shock when the unit is subsequently used.
12. Unplug this unit from the wall outlet and refer servicing to an authorized servicer when the following conditions occur:
 - A. When the power supply cord or plug is damaged or frayed.
 - B. If liquid has been spilled into the unit.
 - C. If the unit has been exposed to rain or water.
 - D. If the unit does not work normally by following the operating instructions. Adjust only controls covered by the operating instructions. Improper adjustment may require extensive work by an authorized servicer.
 - E. If the unit has been dropped or physically damaged.
 - F. If the unit exhibits a distinct change in performance.
13. During thunderstorms, avoid using telephones except cordless types. There may be a remote risk of an electric shock from lightning.
14. Do not use this unit to report a gas leak, when in the vicinity of the leak.

SAVE THESE INSTRUCTIONS

Important Safety Instructions

CAUTION:

To reduce the risk of fire or injury to persons, read and follow these instructions.

1. Use only the battery(ies) specified.
2. Do not dispose of the battery(ies) in a fire. They may explode. Check with local waste management codes for special disposal instructions.
3. Do not open or mutilate the battery(ies). Released electrolyte is corrosive and may cause burns or injury to the eyes or skin. The electrolyte may be toxic if swallowed.
4. Exercise care in handling batteries in order not to short the battery to conductive materials such as rings, bracelets, and keys. The battery and/or conductor may overheat and cause burns.
5. Charge the battery(ies) provided with or identified for use with this product only in accordance with the instructions and limitations specified in this manual.

WARNING:

TO PREVENT FIRE OR SHOCK HAZARD, DO NOT EXPOSE THIS PRODUCT TO RAIN OR ANY TYPE OF MOISTURE.

- The AC adaptor is used as the main disconnect device, ensure that the AC outlet is located/installed near the unit and is easily accessible.

FCC and Other Information

This equipment complies with Part 68 of the FCC rules and the requirements adopted by the ACTA. On the bottom of this equipment is a label that contains, among other information, a product identifier in the format US:ACJ-----.

If requested, this number must be provided to the telephone company.

Registration No. (found on the bottom of the unit)

Ringer Equivalence No. (REN).....0.1B

A plug and jack used to connect this equipment to the premises wiring and telephone network must comply with the applicable FCC Part 68 rules and requirements adopted by the ACTA. A compliant telephone cord and modular plug is provided with this product. It is designed to be connected to a compatible modular jack that is also compliant.

The REN is used to determine the number of devices that may be connected to a telephone line. Excessive RENs on a telephone line may result in the devices not ringing in response to an incoming call. In most but not all areas, the sum of RENs should not exceed five (5.0). To be certain of the number of devices that may be connected to a line, as determined by the total RENs, contact the local telephone company. For products approved after July 23, 2001, the REN for this product is part of the product identifier that has the format US:AAAEQ##TXXXX. The digits represented by ## are the REN without a decimal point (e.g., 03 is a REN of 0.3).

If this equipment causes harm to the telephone network, the telephone company will notify you in advance that temporary discontinuance of service may be required. But if advance notice isn't practical, the telephone company will notify the customer as soon as possible. Also, you will be advised of your right to file a complaint with the FCC if you believe it is necessary.

FCC and Other Information

The telephone company may make changes in its facilities, equipment, operations or procedures that could affect the operation of the equipment. If this happens the telephone company will provide advance notice in order for you to make necessary modifications to maintain uninterrupted service.

If trouble is experienced with this equipment, for repair or warranty information, please contact a Factory Servicenter or other Authorized Servicer. If the equipment is causing harm to the telephone network, the telephone company may request that you disconnect the equipment until the problem is resolved.

Connection to party line service is subject to state tariffs. Contact the state public utility commission, public service commission or corporation commission for information.

If your home has specially wired alarm equipment connected to the telephone line, ensure the installation of this equipment does not disable your alarm equipment. If you have questions about what will disable alarm equipment, consult your telephone company or a qualified installer.

WHEN PROGRAMMING EMERGENCY NUMBERS AND(OR) MAKING TEST CALLS TO EMERGENCY NUMBERS:

- 1) Remain on the line and briefly explain to the dispatcher the reason for the call.
- 2) Perform such activities in the off-peak hours, such as early morning or late evenings.

This device complies with Part 15 of the FCC Rules. Operation is subject to the following two conditions: (1) This device may not cause harmful interference, and (2) this device must accept any interference received, including interference that may cause undesired operation.

Privacy of communications may not be ensured when using this phone.

CAUTION:

Any changes or modifications not expressly approved by the party responsible for compliance could void the user's authority to operate this device.

Note:

This equipment has been tested and found to comply with the limits for a Class B digital device, pursuant to Part 15 of the FCC Rules. These limits are designed to provide reasonable protection against harmful interference in a residential installation. This equipment generates, uses, and can radiate radio frequency energy and, if not installed and used in accordance with the instructions, may cause harmful interference to radio communications. However, there is no guarantee that interference will not occur in a particular installation. If this equipment does cause harmful interference to radio or television reception, which can be determined by turning the equipment off and on, the user is encouraged to try to correct the interference by one or more of the following measures:

- Reorient or relocate the receiving antenna.
- Increase the separation between the equipment and receiver.
- Connect the equipment into an outlet on a circuit different from that to which the receiver is connected.
- Consult the dealer or an experienced radio/TV technician for help.

Some cordless telephones operate at frequencies that may cause interference to nearby TVs and VCRs. To minimize or prevent such interference, the base of the cordless telephone should not be placed near or on top of a TV or VCR. If interference is experienced, move the cordless telephone further away from the TV or VCR. This will often reduce, or eliminate, interference.

FCC and Other Information

Operating near 5.8GHz electrical appliances may cause interference. Move away from the electrical appliances.

FCC RF Exposure Warning:

This product complies with FCC radiation exposure limits set forth for an uncontrolled environment. To comply with FCC RF exposure requirements the base unit must be installed and operated with its antenna located 20 cm or more between antenna and all person's body (excluding extremities of hands, wrist and feet). The handset unit may be carried and operated with only the specific provided belt-clip. Other non-tested belt-clips or similar body-worn accessories may not comply and must be avoided. The base and handset units must not be co-located or operated in conjunction with any other antenna or transmitter.

This equipment is hearing aid compatible as defined by the FCC in 47 CFR Section 68.316.

When you hold the phone to your ear, noise might be heard in your Hearing Aid. Some Hearing Aids are not adequately shielded from external RF (radio frequency) energy. If noise occurs, use an optional headset accessory or the speakerphone option (if applicable) when using this phone. Consult your audiologist or Hearing Aid manufacturer about the availability of Hearing Aids which provide adequate shielding to RF energy commonly emitted by digital devices.

A TIA/EIA-IS-968 compliant telephone cord and modular plug is provided with this equipment. This equipment is designed to be connected to the telephone network or premises wiring using a compatible modular jack that is also TIA/EIA-IS-968 compliant.

The software contained in this equipment to allow user access to the network must be ungraded to recognize newly established network area codes and exchange codes as they are placed into service.

Failure to upgrade the premises systems or peripheral equipment to recognize the new codes as they are established will restrict the customer and the customer's employees from gaining access to the network and to these codes.

- **Environment** — do not place the unit in a room where the temperature is less than 5°C (41°F) or greater than 40°C (104°F). Allow 10 cm (4") clearance around the unit for proper ventilation. Avoid excessive smoke, dust, mechanical vibration, shock, or direct sunlight.
- **Medical** — consult the manufacturer of any personal medical devices, such as pacemakers or hearing aids, to determine if they are adequately shielded from external RF (radio frequency) energy. (The unit operates in the frequency range of 5760MHz to 5840MHz, and the power output level can range 0.25 to 0.5 watts.) Do not use the unit in health care facilities if any regulations posted in the area instruct you not to do so. Hospitals or health care facilities may be using equipment that could be sensitive to external RF (radio frequency) energy.
- **Routine care** — wipe the unit with a soft cloth. Do not use benzine, thinner, or any abrasive powder. When you leave the unit unused for a long period of time, unplug the AC adaptor from the outlet.
- **If there is any trouble** — disconnect the unit from the telephone line and connect a known working phone. If the known working phone operates properly, have your unit repaired by one of the authorized Panasonic Factory Service Centers. If the known working phone does not operate properly, consult your telephone company.

Index

- A**
- Accessories 2
 - Answering calls 22
 - Auto talk 15, 22
- B**
- Backlit LCD 21
 - Base unit location 6
 - Battery charge 3, 10
 - *Battery information* 11
 - Battery replacement 10, 11
 - Battery strength 10
 - Belt clip 41
 - *Booster* 21
- C**
- Call Waiting Caller ID display 38
 - Call waiting tone 38
 - *Caller ID number auto edit* 26, 27
 - Caller ID service 23
 - Caller IQ 51
 - Caller List, editing 26
 - Caller List, erasing 28
 - Caller List, storing 28
 - Caller List, viewing 24
 - Calling back from the Caller List 25
 - *Chain dial* 32
 - CID (Caller ID) 23
 - *Clarity booster* 21
- D**
- Dialing mode 14
 - Direct commands 45, 46
 - Display 8
 - Display language 14
- E**
- Error messages 47
- F**
- FCC and other information 56
 - FLASH button 39
 - Flash time 39
 - *Function menu, Direct commands* 45, 46
 - Function menu, selection 12
 - Function menu, table 13
- H**
- Handset locator 37
 - Headset, optional 41
 - Hold 20
- I**
- Installation, AC adaptor 9
 - Installation, battery 10
 - Installation, telephone line cord 9
- K**
- Key tone 40
- L**
- LCD contrast 18
 - Lighted handset keypad 21
 - Line mode 15
 - Location of controls 6, 7
- M**
- Making calls 19
 - *Message alert* 18
 - Microphone, handset 19
 - Mute 37
- N**
- Navigator key 7
 - Noise 3
- O**
- openLCR 51
- P**
- PAUSE 38
 - *Phone book* 29
 - Phone book, dialing 31, 32
 - Phone book, downloading 52
 - Phone book, editing 33
 - Phone book, erasing 33
 - Phone book, names 30
 - Phone book, storing 29
 - Power failure 9
 - Pulse service 37

Index

R

Redial	20
Redial list	20
– <i>Registration</i>	40
Ringer off	16, 22
Ringer tone	17
Ringer volume	16, 22
Rotary service, tone dialing	37

S

Safety instructions	55
Shipping product for service Back cover	
Soft keys	7
Specifications	63
SP-phone	19

T

Troubleshooting	48
TTY	2, 62, Back Cover

V

VE (Voice Enhancer)	21
– <i>VM (Voice Mail)</i>	34
– <i>Voice enhancer technology</i>	21
Volume control	20

W

Wall mounting	42
Warranty	61

- “–” indicates important information and frequently used features.

**PANASONIC CONSUMER
ELECTRONICS COMPANY, DIVISION
OF MATSUSHITA ELECTRIC
CORPORATION OF AMERICA**
One Panasonic Way
Secaucus, New Jersey 07094

**PANASONIC SALES COMPANY,
DIVISION OF MATSUSHITA
ELECTRIC OF PUERTO RICO, INC.,**
Ave. 65 de Infanteria, Km. 9.5
San Gabriel Industrial Park
Carolina, Puerto Rico 00985

Panasonic Telephone Products Limited Warranty

Limited Warranty Coverage

If your product does not work properly because of a defect in materials or workmanship, Panasonic Consumer Electronics Company or Panasonic Sales Company (collectively referred to as "the warrantor") will, for the length of the period indicated on the chart below, which starts with the date of original purchase ("Limited Warranty period"), at its option either (a) repair your product with new or refurbished parts, or (b) replace it with a new or a refurbished product. The decision to repair or replace will be made by the warrantor.

Parts	Labor
One (1) Year	One (1) Year

During the "Labor" Limited Warranty period there will be no charge for labor. During the "Parts" Limited Warranty period, there will be no charge for parts. You must mail-in your product during the Limited Warranty period. This Limited Warranty excludes both parts and labor for batteries, antennas, and cosmetic parts (cabinet). This Limited Warranty only applies to products purchased and serviced in the United States or Puerto Rico. This Limited Warranty is extended only to the original purchaser and only covers products purchased as new.

Mail-In Service

For assistance in the continental U.S.A. in obtaining repairs please ship the product to:

**Panasonic Services Company Customer Servicenter
Suite B 4900 George McVay Drive McAllen, TX 78503**

For assistance in Puerto Rico call Panasonic Sales Company (787)-750-4300 or fax (787)-768-2910.

For Limited Warranty service for headsets if a headset is included with this product please call Panasonic Call Center at 1-800-211-PANA (7262).

When shipping the unit carefully pack, include all accessories, and send it prepaid, adequately insured and preferably in the original carton. Include a letter detailing the complaint and provide a day time phone number where you can be reached.

IF REPAIR IS NEEDED DURING THE LIMITED WARRANTY PERIOD THE PURCHASER WILL BE REQUIRED TO FURNISH A SALES RECEIPT/PROOF OF PURCHASE INDICATING DATE OF PURCHASE, AMOUNT PAID AND PLACE OF PURCHASE. CUSTOMER WILL BE CHARGED FOR THE REPAIR OF ANY UNIT RECEIVED WITHOUT SUCH PROOF OF PURCHASE.

Limited Warranty Limits And Exclusions

This Limited Warranty ONLY COVERS failures due to defects in materials or workmanship, and DOES NOT COVER normal wear and tear or cosmetic damage. The Limited Warranty ALSO DOES NOT COVER damages which occurred in shipment, or failures which are caused by products not supplied by the warrantor, or failures which result from accidents, misuse, abuse, neglect, mishandling, misapplication, alteration, faulty installation, set-up adjustments, misadjustment of consumer controls, improper maintenance, power line surge, lightning damage, modification, introduction of sand, humidity or liquids, commercial use such as hotel, office, restaurant, or other business or rental use of the product, or service by anyone other than a Factory Servicenter or other Authorized Servicer, or damage that is attributable to acts of God.

THERE ARE NO EXPRESS WARRANTIES EXCEPT AS LISTED UNDER "LIMITED WARRANTY COVERAGE". THE WARRANTOR IS NOT LIABLE FOR INCIDENTAL OR CONSEQUENTIAL DAMAGES RESULTING FROM THE USE OF THIS PRODUCT, OR ARISING OUT OF ANY BREACH OF THIS LIMITED WARRANTY. (As examples, this excludes damages for lost time, lost calls or messages, cost of having someone remove or re-install an installed unit if applicable, travel to and from the servicer. The items listed are not exclusive, but are for illustration only.) **ALL EXPRESS AND IMPLIED WARRANTIES, INCLUDING THE WARRANTY OF MERCHANTABILITY, ARE LIMITED TO THE PERIOD OF THE LIMITED WARRANTY.**

Some states do not allow the exclusion or limitation of incidental or consequential damages, or limitations on how long an implied warranty lasts, so the exclusions may not apply to you. This Limited Warranty gives you specific legal rights and you may also have other rights which vary from state to state. If a problem with this product develops during or after the Limited Warranty period, you may contact your dealer or Servicenter. If the problem is not handled to your satisfaction, then write to the warrantor's Consumer Affairs Department at the addresses listed for the warrantor.

PARTS AND SERVICE, WHICH ARE NOT COVERED BY THIS LIMITED WARRANTY, ARE YOUR RESPONSIBILITY.

Customer Services Directory

Obtain Product Information and Operating Assistance; locate your nearest Dealer or Servicenter; purchase Parts and Accessories; or make Customer Service and Literature requests by visiting our Web Site at:

<http://www.panasonic.com/support>

or, contact us via the web at:

<http://www.panasonic.com/contactinfo>

You may also contact us directly at: 1-800-211-PANA (7262),
Monday-Friday 9 am-9 pm; Saturday-Sunday 10 am-7 pm, EST.

For hearing or speech impaired TTY users, TTY : 1-877-833-8855

Accessory Purchases

Purchase Parts, Accessories and Instruction Books online for all Panasonic Products by visiting our Web Site at:

<http://www.pasc.panasonic.com>

or, send your request by E-mail to:

npcparts@panasonic.com

You may also contact us directly at:

1-800-332-5368 (Phone) 1-800-237-9080 (Fax Only)

(Monday - Friday 9 am to 8 pm, EST.)

Panasonic Services Company

20421 84th Avenue South, Kent, WA 98032

(We Accept Visa, MasterCard, Discover Card, American Express,
and Personal Checks)

For hearing or speech impaired TTY users, TTY : 1-866-605-1277

Service in Puerto Rico

***Matsushita Electric of Puerto Rico, Inc. Panasonic Sales Company
Factory Servicenter:***

***Ave. 65 de Infantería, Km. 9.5, San Gabriel Industrial Park,
Carolina, Puerto Rico 00985***

Phone (787)750-4300, Fax (787)768-2910

Specifications

■ Handset

- Power Supply:** Ni-MH battery (3.6 V, 830 mAh)
Frequency: 5.76 GHz – 5.84 GHz
Dimensions (H x W x D): Approx. 220 mm x 53 mm x 37 mm
($8\frac{21}{32}$ " x $2\frac{3}{32}$ " x $1\frac{15}{32}$ ")
Mass (Weight): Approx. 210 g (0.46 lb.)
Security Codes: 1,000,000

■ Base Unit

- Power Supply:** AC adaptor (120 V AC, 60 Hz)
Power Consumption: Standby: Approx. 2.3 W
Maximum: Approx. 5.5 W
Frequency: 5.76 GHz – 5.84 GHz
Dimensions (H x W x D): Approx. 107 mm x 214 mm x 135 mm
($4\frac{7}{32}$ " x $8\frac{7}{16}$ " x $5\frac{5}{16}$ ")
Mass (Weight): Approx. 340 g (0.75 lb.)

■ **Dialing Mode:** Tone (DTMF)/Pulse

■ **Operating Environment:** 5 °C – 40 °C (41 °F – 104 °F)

Specifications are subject to change without notice.

For your future reference

Serial No. _____

Date of purchase _____

(found on the bottom of the unit)

Name and address of dealer _____

Energy Star:

As an ENERGY STAR® Participant, Panasonic has determined that this product meets the ENERGY STAR guidelines for energy efficiency. ENERGY STAR is a U.S. registered mark.



For product service

- Visit our website: <http://www.panasonic.com/support>
- Contact us via the web at: <http://www.panasonic.com/contactinfo>
- Call us at: 1-800-211-PANA(7262)

When you ship the product

- Carefully pack your unit, preferably in the original carton.
- Attach a letter, detailing the symptom, to the outside of the carton.

Symptom

- Send the unit to an authorized servicer, prepaid and adequately insured.
- Do not send your unit to the Panasonic Consumer Electronics Company listed below or to executive or regional sales offices. These locations do not repair consumer products.

- This cordless telephone is designed for use in the United States of America. Sale or use of this product in other countries may violate local laws.
- Ce téléphone sans fil est conçu pour être utilisé aux États-Unis d'Amérique. La vente ou l'emploi de cet appareil dans certains autres pays peut constituer une infraction à la législation locale.
- Este teléfono inalámbrico fue elaborado para uso en los Estados Unidos de América. La venta o el empleo de este producto en ciertos países puede constituir violación de la legislación local.
- このコードレス電話機は、日本国外での使用を目的として設計されており、日本国内での使用は法律違反となります。従って、当社では日本国内においては原則として修理などのサービスは致しかねます。

If you need assistance with setup or operation, please call 1-800-211-PANA(7262)

For hearing or speech impaired TTY users, TTY : 1-877-833-8855

**Panasonic Consumer Electronics Company,
Division of Matsushita Electric Corporation of America**
One Panasonic Way, Secaucus, New Jersey 07094

**Panasonic Sales Company,
Division of Matsushita Electric of Puerto Rico, Inc.**
Ave. 65 de Infantería, Km. 9.5, San Gabriel Industrial Park
Carolina, Puerto Rico 00985

© 2004 Panasonic Communications Co., Ltd. All Rights Reserved.