

MAS1175

IC FOR 10.00 – 20.00 MHz VCTCXO

- Low Power
- Wide Supply Voltage Range
- True Sine Wave Output
- Very High Level of Integration
- Electrically Trimmable
- Very Low Phase Noise
- Low Cost

DESCRIPTION

The MAS1175 is an integrated circuit well suited to build VCTCXO for mobile communication. Only two external components are needed. Temperature calibration is achieved with three calibration points only. The trimming is done through a serial bus and the calibration information is stored in an internal PROM.

To build a VCTCXO only two additional components, a varactor and a crystal are needed. The compensation method is fully analog. IC compensation work is continuous without generating any steps or other interferences.

FEATURES

- Very small size
- Minimum current draw
- Wide operating temperature range
- Phase noise <-130 dBc/Hz at 1 kHz offset
- VCTCXO for mobile phones

APPLICATIONS

- VCTCXO for other telecommunications systems

BLOCK DIAGRAM

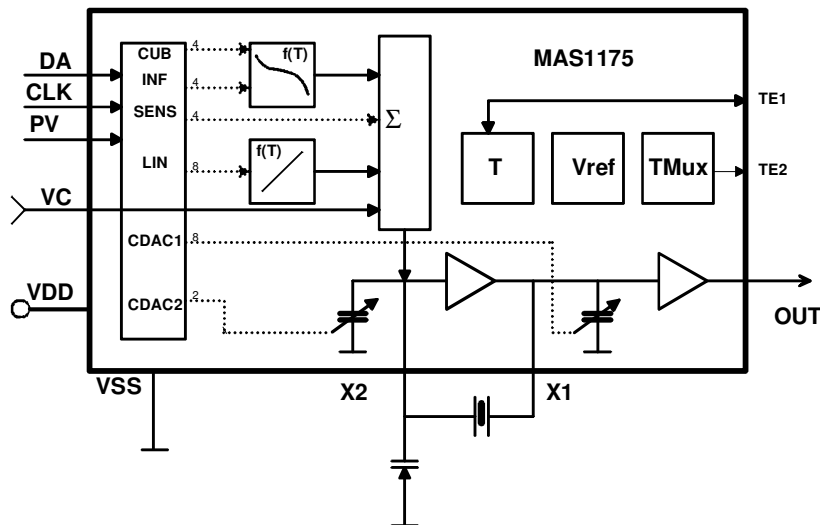

PIN DESCRIPTION

Pin Description	Symbol	x-coordinate	y-coordinate
Power Supply Voltage	VDD	263	1330
Programming Input	PV	503	1326
Serial Bus Clock Input	CLK	745	1321
Serial Bus Data Input	DA	1001	1321
Temperature Output	TE1	1246	1325
Test Multiplexer Output	TE2	1454	1325
Voltage Control Input	VC	190	231
Crystal Oscillator Output	X1	398	231
Crystal/Varactor Oscillator Input	X2	1355	231
Power Supply Ground	VSS	1828	242
Buffer Output	OUT	2031	231

Note: Because the substrate of the die is internally connected to VDD, the die has to be connected to VDD or left floating. Make sure that VDD is the first pad to be bonded. Pick-and-place and all component assembly are recommended to be performed in ESD protected area.

Note: Pad coordinates are measured from the left bottom corner of the chip to the center of the pads. The coordinates may vary depending on sawing width and location, however, distances between pads are accurate.

ABSOLUTE MAXIMUM RATINGS

Parameter	Symbol	Min	Max	Unit	Note
Supply Voltage	$V_{DD} - V_{SS}$	-0.3	6.0	V	
Input Voltage	V_{IN}	$V_{SS} - 0.3$	$V_{DD} + 0.3$	V	1)
Power Dissipation	P_{MAX}		20	mW	
Storage Temperature	T_{ST}	-55	150	°C	

Note: Not valid for programming pin PV

RECOMMENDED OPERATION CONDITIONS

Parameter	Symbol	Conditions	Min	Typ	Max	Unit
Supply Voltage	V_{DD}		2.7	2.8	5.5	V
Supply Current	I_{CC}	$V_{CC} = 2.8$ Volt			1.8	mA
Operable Temperature	T_C		-30		+85	°C
Storage Temperature	T_S	Relative humidity = 15%...70%	-5		+40	°C
Crystal Pulling Sensitivity	S			30		ppm/pF
Load Capacitance	C_L			10		pF

ELECTRICAL CHARACTERISTICS

Parameter	Symbol	Min	Typ	Max	Unit	Note
Frequency Range	f_o	10.00		20.00	MHz	
Voltage Control Range	V_C	0		Vdd		
Voltage Control Sensitivity	V_{CSENS}		10		ppm/V	
Output Voltage (10k Ω // 10 pF)	V_{out}		1.0		Vpp	
Compensation Range \pm 2.5 ppm	T_C	-30		85	$^{\circ}C$	
Compensation Range \pm 2.0 ppm	T_C	-25		75	$^{\circ}C$	
Compensation Range Linear Part	a1	-0.7		0.0	ppm/K	
Compensation Inflection Point	INF	25		31	$^{\circ}C$	
Compensation Range Cubic Part	a3		95		ppm ² /K ³	
Compensation CDAC1 (8 Bit)	C_{X1}	C10		C10 + 18	pF	2)
Compensation CDAC2 (2 Bit)	C_{X2}	C20		C20 + 4	pF	3)
Startup Time	T_{START}		2		ms	

Note 2: typ C10 = 14pF

Note 3: typ C20 = 5pF (varactor capacitance has to be added)

IC OUTLINES

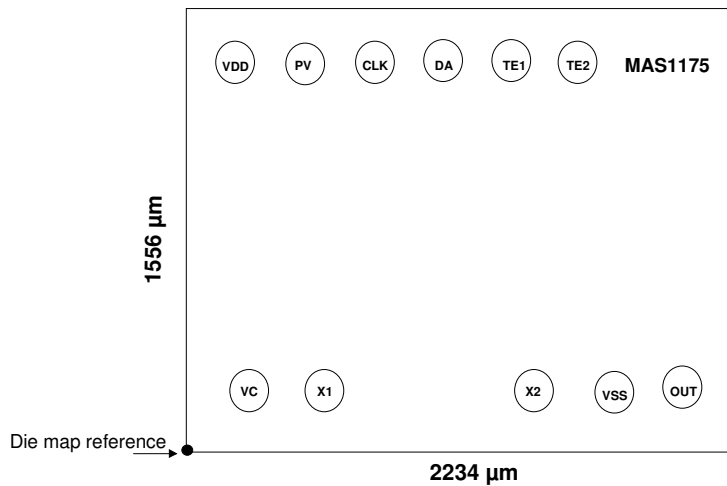

Note 1: MAS1175A pads are round with 95 μm diameter at opening.

Note 2: Pins PV and TE1 shall not be connected and pins CLK and DA can either be connected to VSS or left open in VCTCXO module end-user application.

Note 3: Die map reference is the actual left bottom corner of the sawn chip.

DEVICE OUTLINE CONFIGURATION

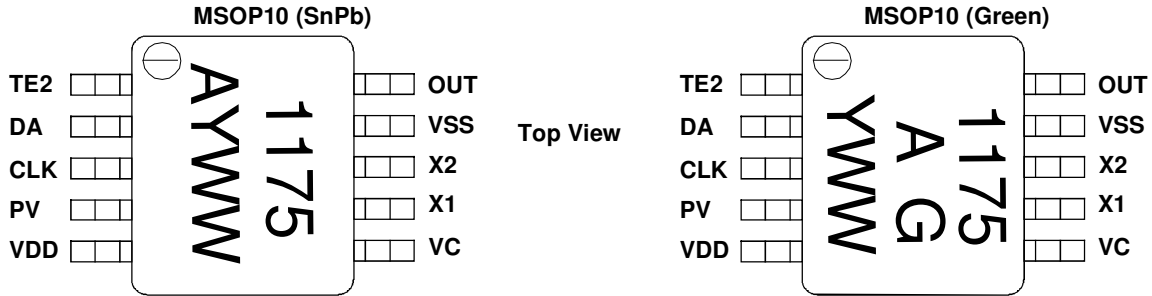

A = product version
Y = year
WW= week

A = product version
Y = year
WW= week
G=Green/RoHs Compliant

PACKAGE (MSOP-10) OUTLINE

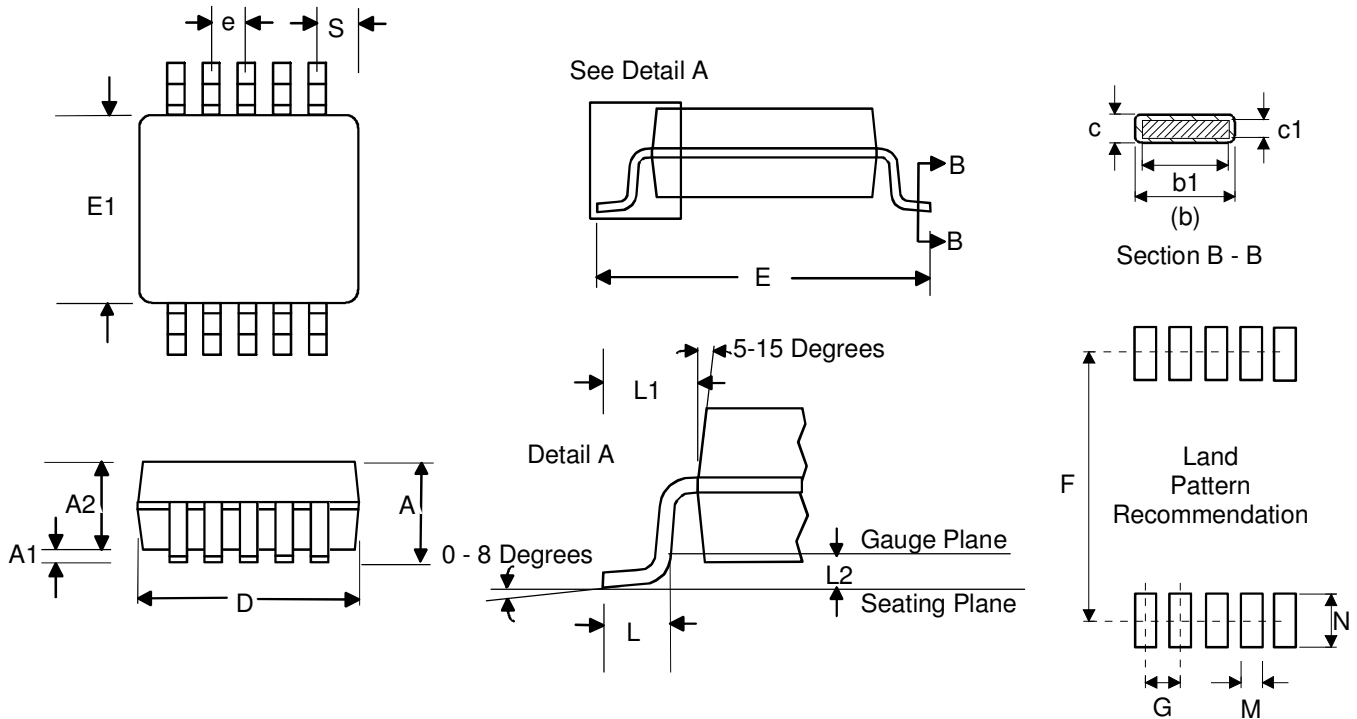

Symbol	Min	Nom	Max	Unit
A	--	--	1.10	mm
A1	0.00	--	0.15	mm
A2	0.75	0.85	0.95	mm
b	0.15	--	0.30	mm
b1	0.15	---	0.25	mm
c	0.08		0.23	mm
c1	0.08		0.18	mm
D		3.00 BSC		mm
E		4.90 BSC		mm
E1		3.00 BSC		mm
e		0.50 BSC		mm
F		4.8		mm
G		0.50		mm
L	0.40	0.60	0.80	mm
(Terminal length for soldering)				
L1		0.95 REF		
L2		0.25 BSC		mm
M		0.41		mm
N		1.02		mm
S		0.50		Mm

Dimensions do not include mold or interlead flash, protrusions or gate burrs.
Reference Standard : JEDEC MO-187 BA.

SOLDERING INFORMATION

◆ For Sn/Pb MSOP-10

Resistance to Soldering Heat	According to RSH test IEC 68-2-58/20 2*220°C
Maximum Temperature	240°C
Maximum Number of Reflow Cycles	3
Reflow profile	Thermal profile parameters stated in JESD22-A113 should not be exceeded. http://www.jedec.org
Seating Plane Co-planarity	max 0.08 mm
Lead Finish	Solder plate 7.62 - 25.4 µm, material Sn 85% Pb 15%

◆ For Pb Free, RoHS Compliant MSOP-10

Resistance to Soldering Heat	According to RSH test IEC 68-2-58/20
Maximum Temperature	260°C
Maximum Number of Reflow Cycles	3
Reflow profile	Thermal profile parameters stated in IPC/JEDEC J-STD-020 should not be exceeded. http://www.jedec.org
Lead Finish	Solder plate 7.62 - 25.4 µm, material Matte Tin

EMBOSSED TAPE SPECIFICATIONS

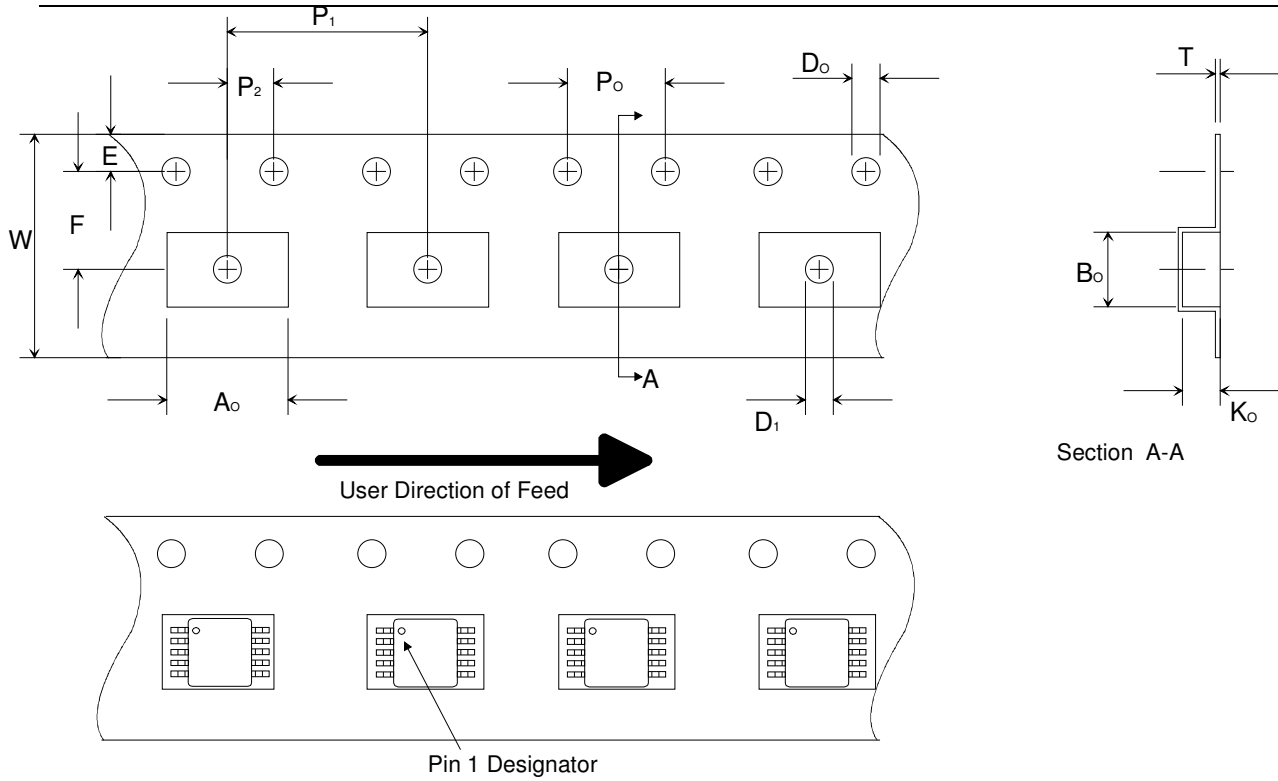

Dimension	Min/Max	Unit
A_0	5.00 \pm 0.10	mm
B_0	3.20 \pm 0.10	mm
D_0	1.50 +0.1/-0.0	mm
D_1	1.50 min	mm
E	1.75	mm
F	5.50 \pm 0.05	mm
K_0	1.45 \pm 0.10	mm
P_0	4.0	mm
P_1	8.0 \pm 0.10	mm
P_2	2.0 \pm 0.05	mm
T	0.3 \pm 0.05	mm
W	12.00 +0.30/-0.10	mm

REEL SPECIFICATIONS

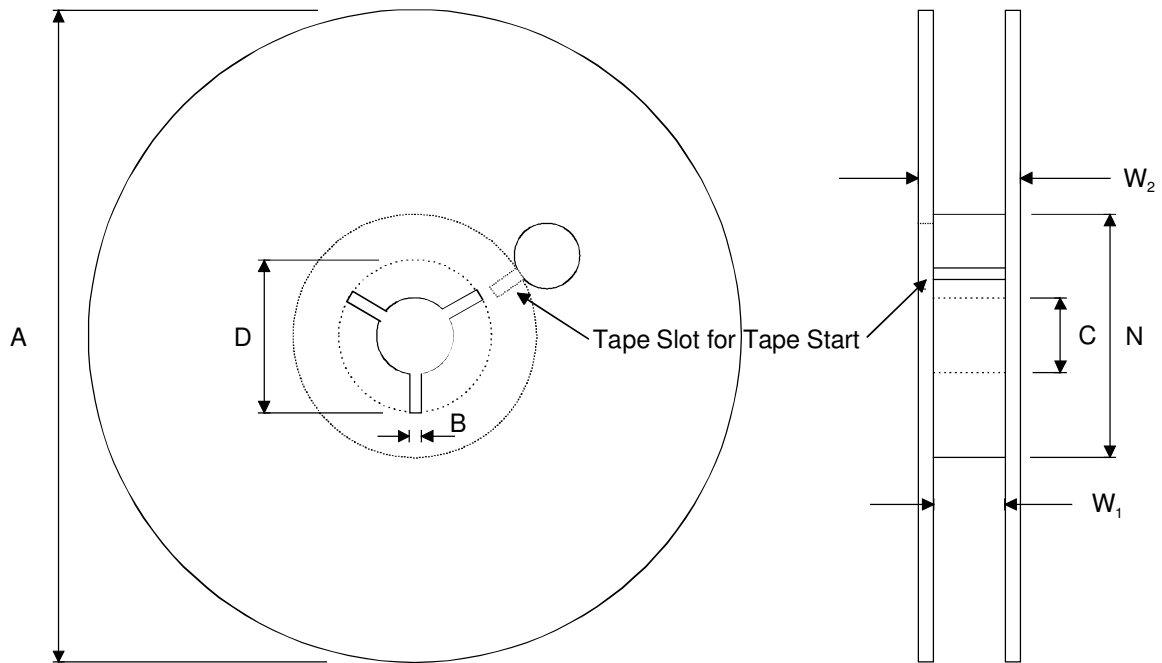

5000 Components on Each Reel
 Reel Material: Conductive, Plastic Antistatic or Static Dissipative
 Carrier Tape Material: Conductive
 Cover Tape Material: Static Dissipative

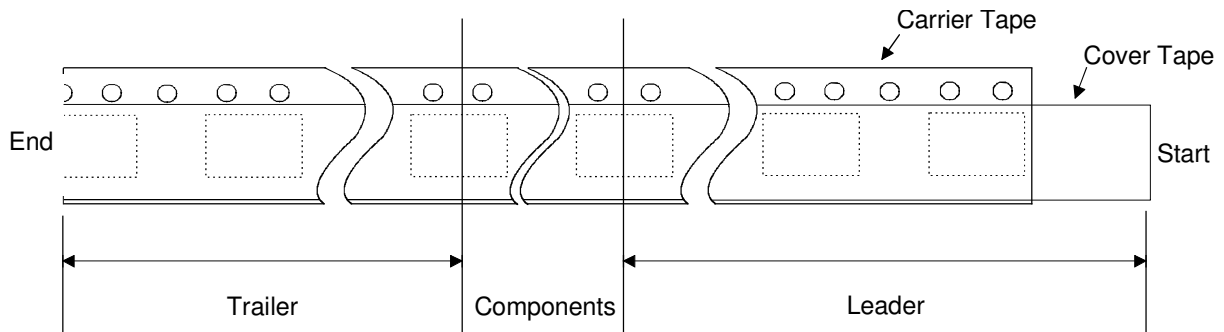

Dimension	Min	Max	Unit
A		330	mm
B	1.5		mm
C	12.80	13.50	mm
D	20.2		mm
N	50		mm
W_1 (measured at hub)	12.4	14.4	mm
W_2 (measured at hub)		18.4	mm
Trailer	160		mm
Leader	390, of which minimum 160 mm of empty carrier tape sealed with cover tape		mm
Weight		1500	g

ORDERING INFORMATION

Product Code	Product	Package	Comments
MAS1175ATB1	IC FOR VCTCXO	Tested wafers, 480 µm	Die Size 2.233x1.556 mm
MAS1175ASM1-T	IC FOR VCTCXO	MSOP10	Tape & Reel
MAS1175A1SN06	IC FOR VCTCXO	Green MSOP-10, Pb Free, RoHS Compliant	Tape & Reel

Please contact Micro Analog Systems Oy for other wafer thickness options.

LOCAL DISTRIBUTOR

--

MICRO ANALOG SYSTEMS OY CONTACTS

Micro Analog Systems Oy Kamreerintie 2, P.O. Box 51 FIN-02771 Espoo, FINLAND	Tel. +358 9 80 521 Fax +358 9 805 3213 http://www.mas-oy.com
--	--

NOTICE

Micro Analog Systems Oy reserves the right to make changes to the products contained in this data sheet in order to improve the design or performance and to supply the best possible products. Micro Analog Systems Oy assumes no responsibility for the use of any circuits shown in this data sheet, conveys no license under any patent or other rights unless otherwise specified in this data sheet, and makes no claim that the circuits are free from patent infringement. Applications for any devices shown in this data sheet are for illustration only and Micro Analog Systems Oy makes no claim or warranty that such applications will be suitable for the use specified without further testing or modification.