

SHINDENGEN

Sidac

K1V34(W)

OUTLINE DIMENSIONS

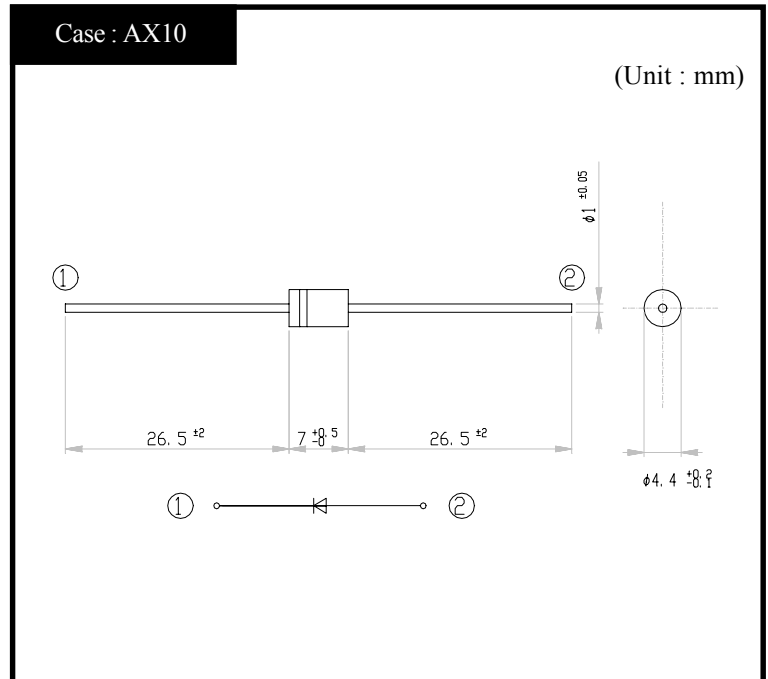

RATINGS

● Absolute Maximum Ratings

Item	Symbol	Conditions	Ratings	Unit
Storage Temperature	T_{stg}		-40~125	°C
Operating Junction Temperature	T_j		125	°C
Maximum Off-state Voltage	V_{DRM}		270	V
RMS On-state Current	I_T	$T_l = 92^\circ\text{C}$, 50Hz sine wave ($\theta = 180^\circ$)	1	A
Surge On-state Current	I_{TSM}	$T_j = 25^\circ\text{C}$, 50Hz sine wave ($\theta = 180^\circ$), non-repetitive 1-cycle peak value	13	A
Pulse On-state Current	I_{TRM}	$T_a = 25^\circ\text{C}$, pulse width $t_o = 10 \mu\text{s}$, sine wave, repetitive peak value $f = 1 \text{ kHz}$	15	A
		$T_a = 25^\circ\text{C}$, pulse width $t_o = 10 \mu\text{s}$, sine wave, repetitive peak value $f = 60 \text{ Hz}$	40	A
Critical Rate of Rise of On-state Current	di_T/dt		50	A/ μs

● Electrical Characteristics ($T_l=25^\circ\text{C}$)

Item	Symbol	Conditions	Ratings	Unit
Breakover Voltage	V_{BO}	$I_B = 0$, 50Hz sine wave	320~360	V
Off-state Current	I_{DRM}	$V_D = V_{DRM}$	Max 10	μA
Breakover Current	I_{BO}		Max 0.5	mA
Holding Current	I_H		TYP 50	mA
On-state Voltage	V_T	$I_T = 1\text{A}$	Max 3.0	V
Switching Resistance	R_S		Min 0.1	$\text{k}\Omega$
Thermal Resistance	$\theta_{j\ell}$	Junction to lead	Max 15	°C/W

● Standard Design with P.C.B.

Item	Symbol	Conditions	Standard	Unit
RMS On-state Current	I_T	Assembled in P.C.B., $T_a = 25^\circ\text{C}$, soldering land 3mm ϕ	0.55	A

K1V33(W)
K1V34(W)
K1V36(W)
K1V38(W) Typical On-State Voltage

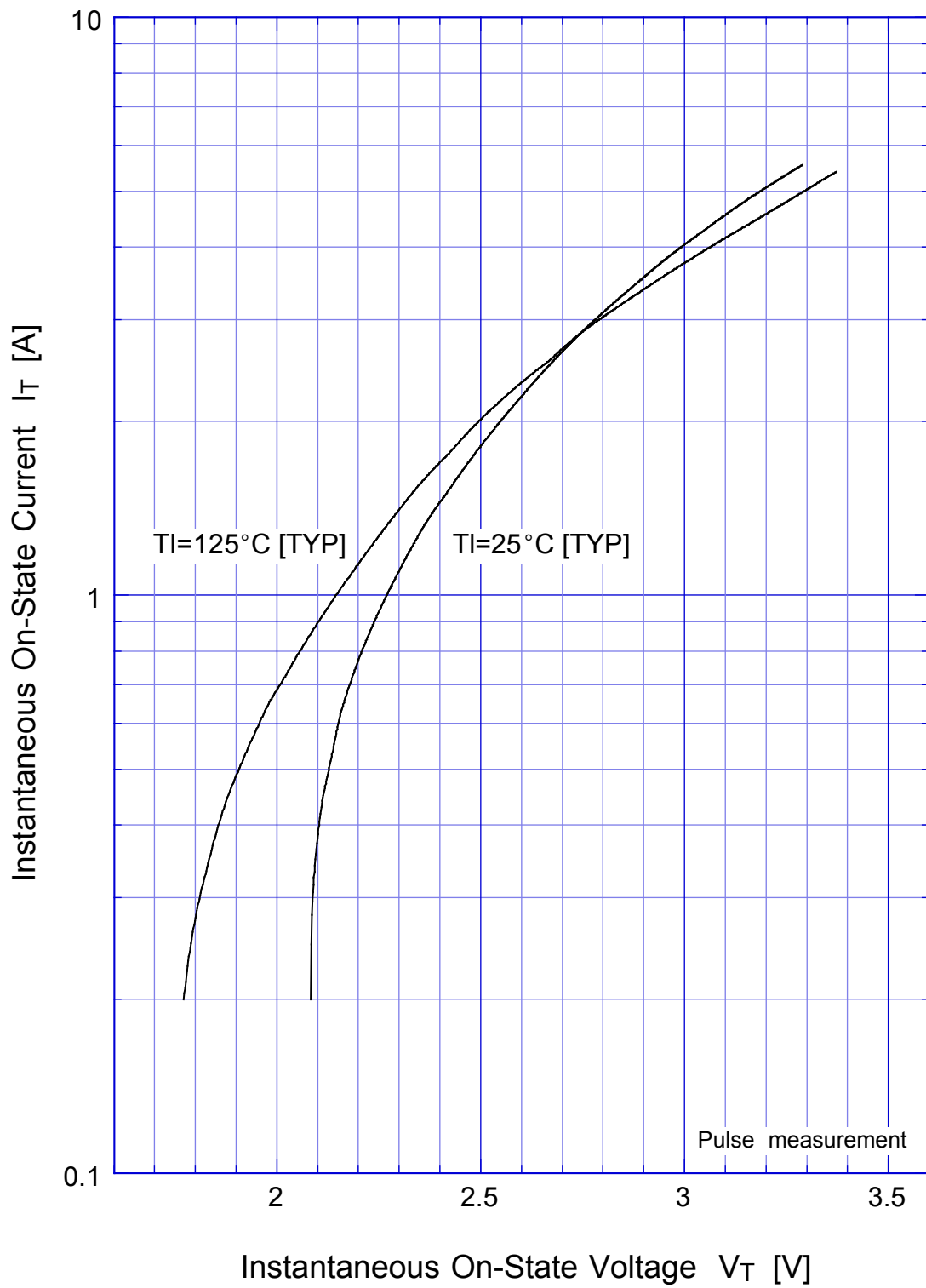

K1V33(W)

K1V34(W)

K1V36(W)

K1V38(W)

Power Dissipation

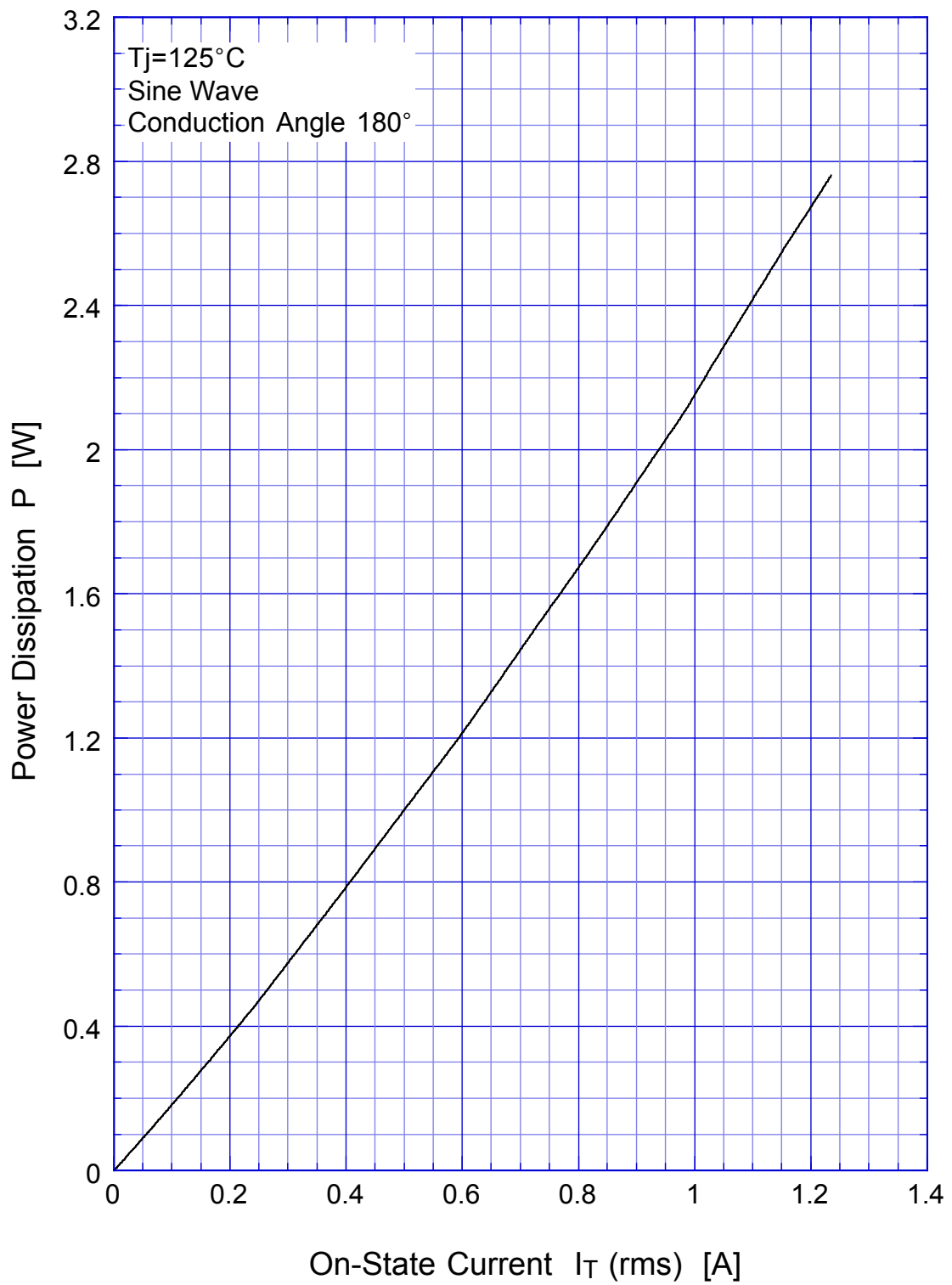

K1V33(W)
 K1V34(W)
 K1V36(W)
 K1V38(W)

Transient Thermal Resistance

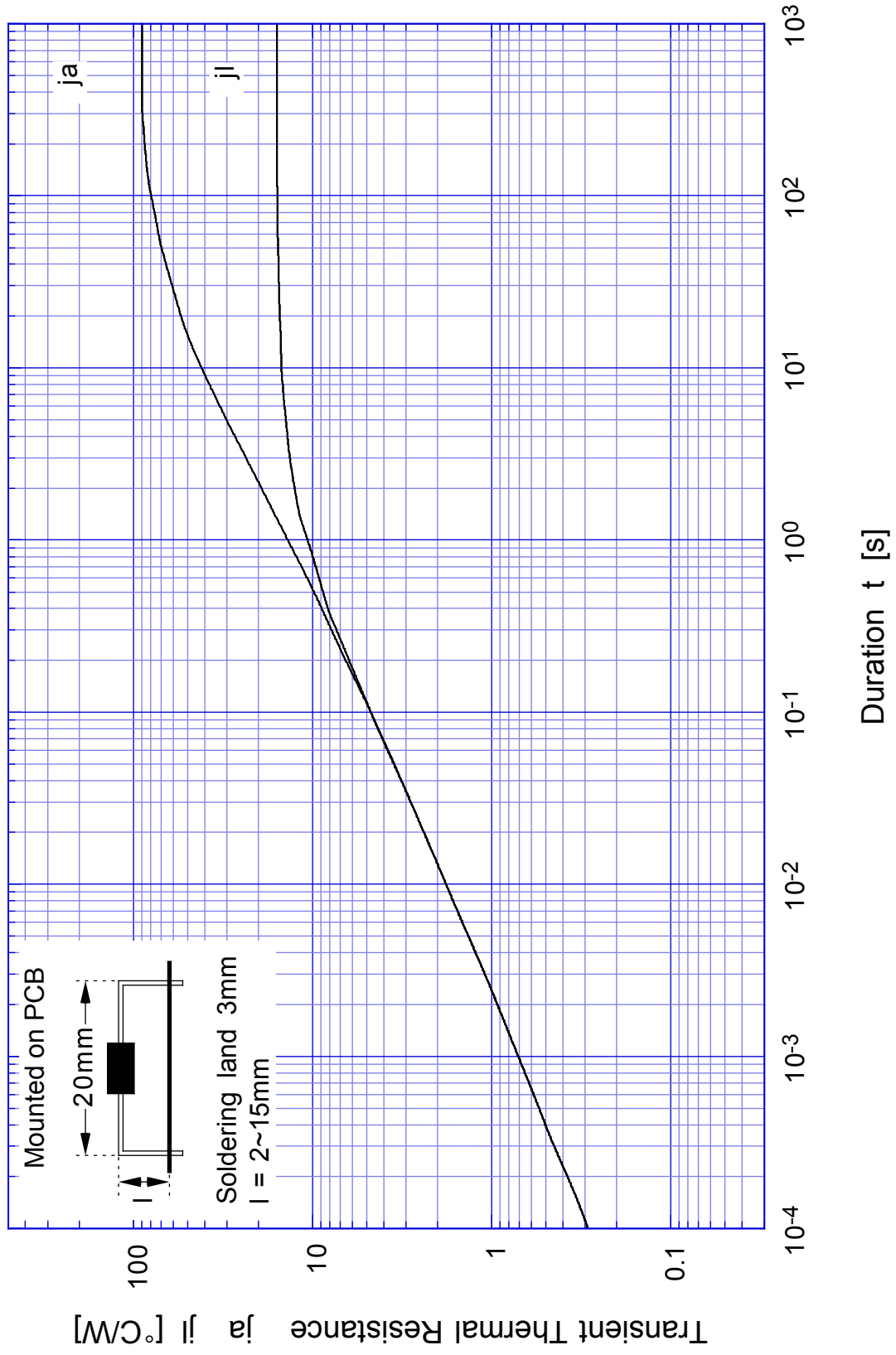

K1V33(W)
K1V34(W)
K1V36(W)
K1V38(W)

Breakover Voltage - Junction Temperature

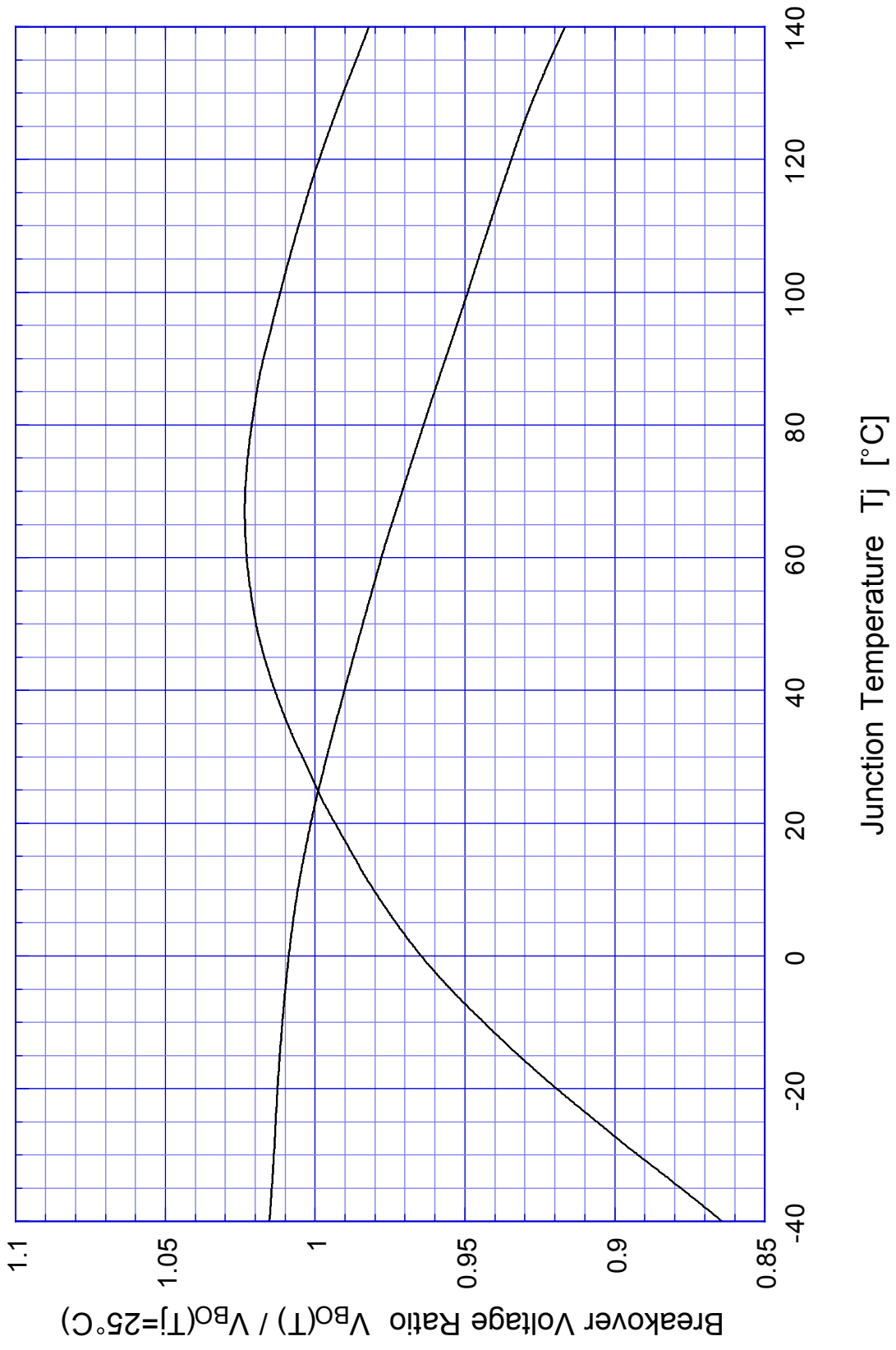

K1V33(W)

K1V34(W)

K1V36(W)

K1V38(W)

Maximum Lead Temperature

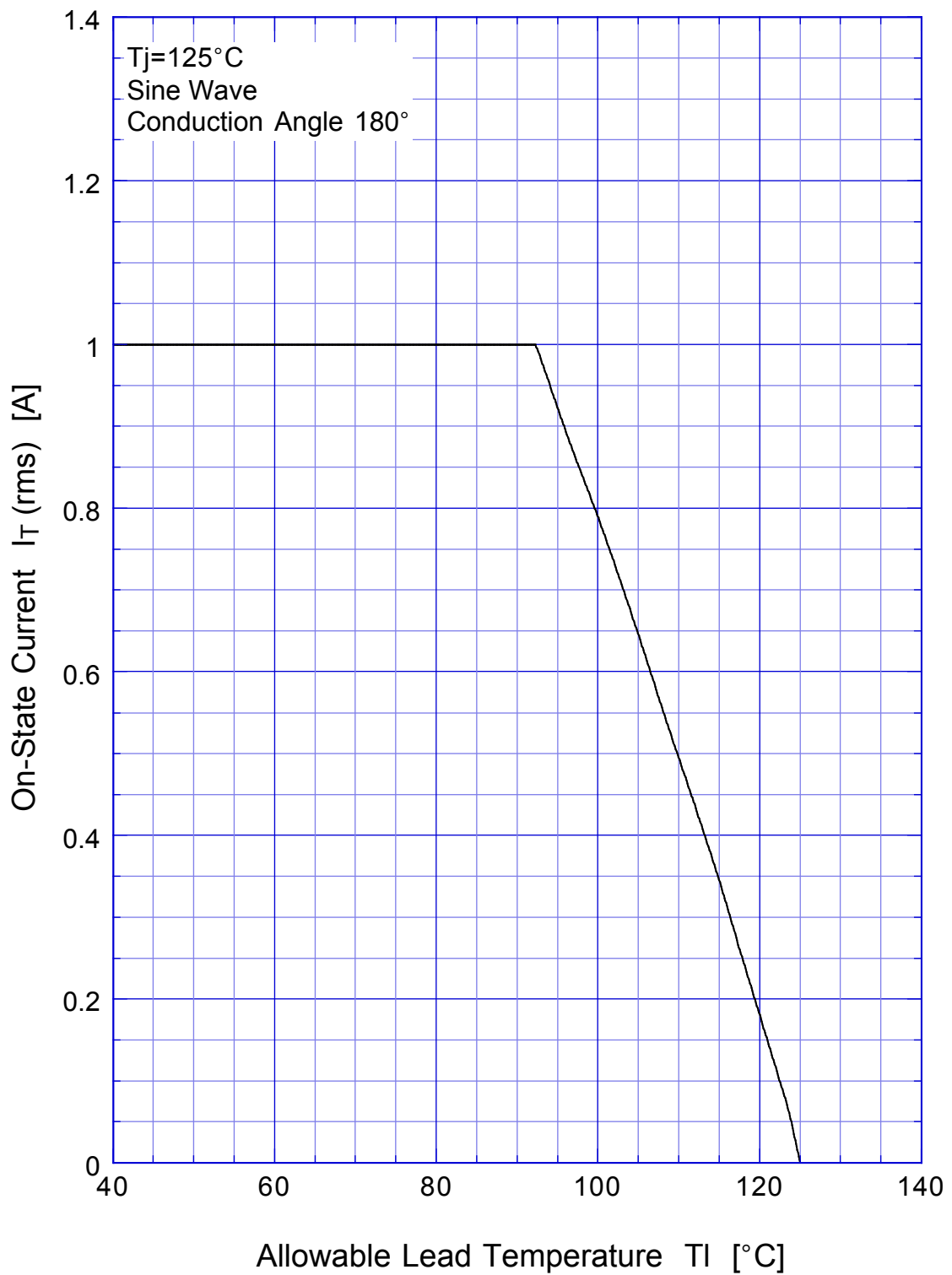

K1V33(W)
K1V34(W)
K1V36(W)
K1V38(W) Maximum Ambient Temperature

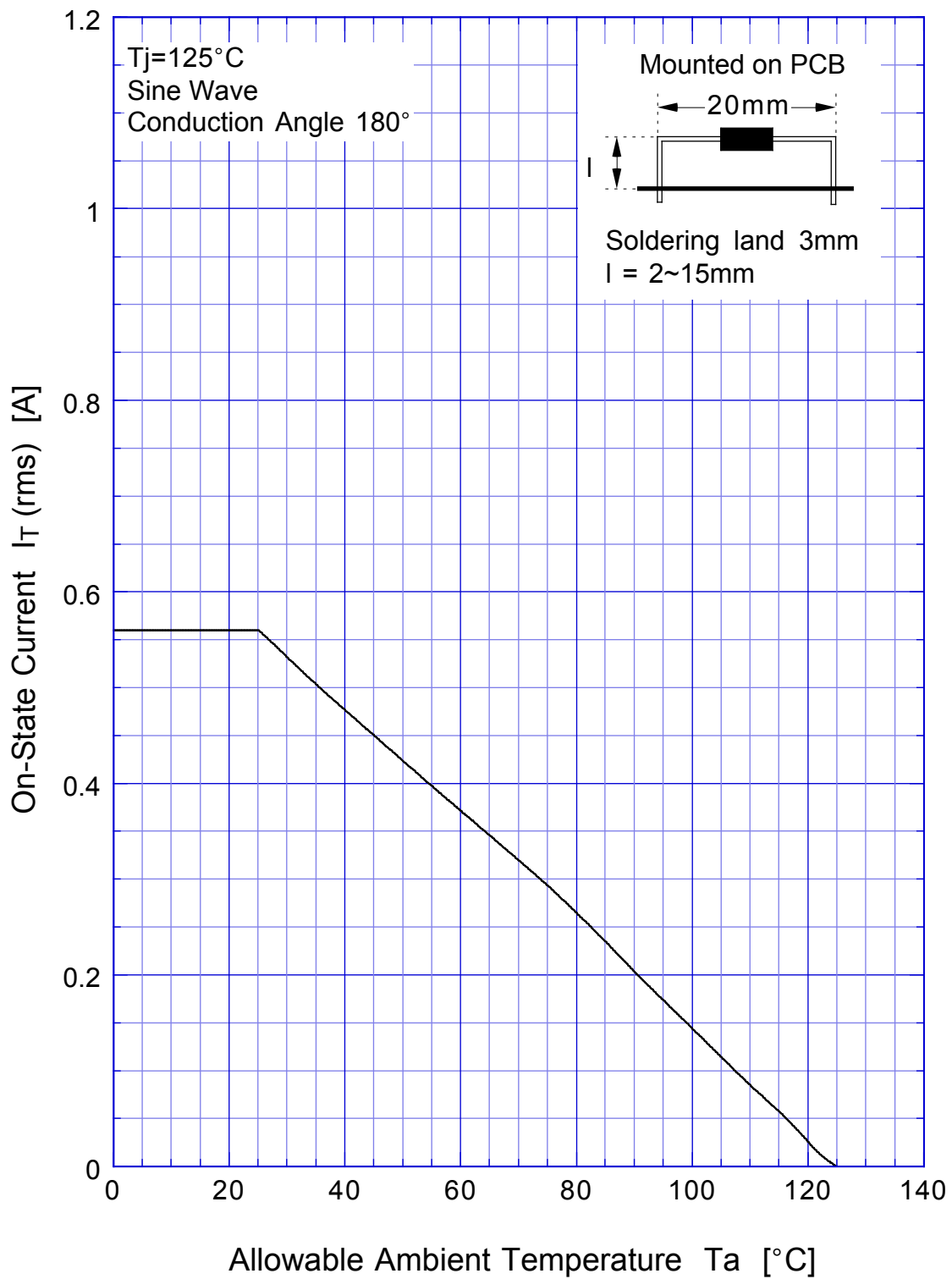

K1V33(W)
K1V34(W)
K1V36(W)
K1V38(W)

Maximum Surge On-State Current

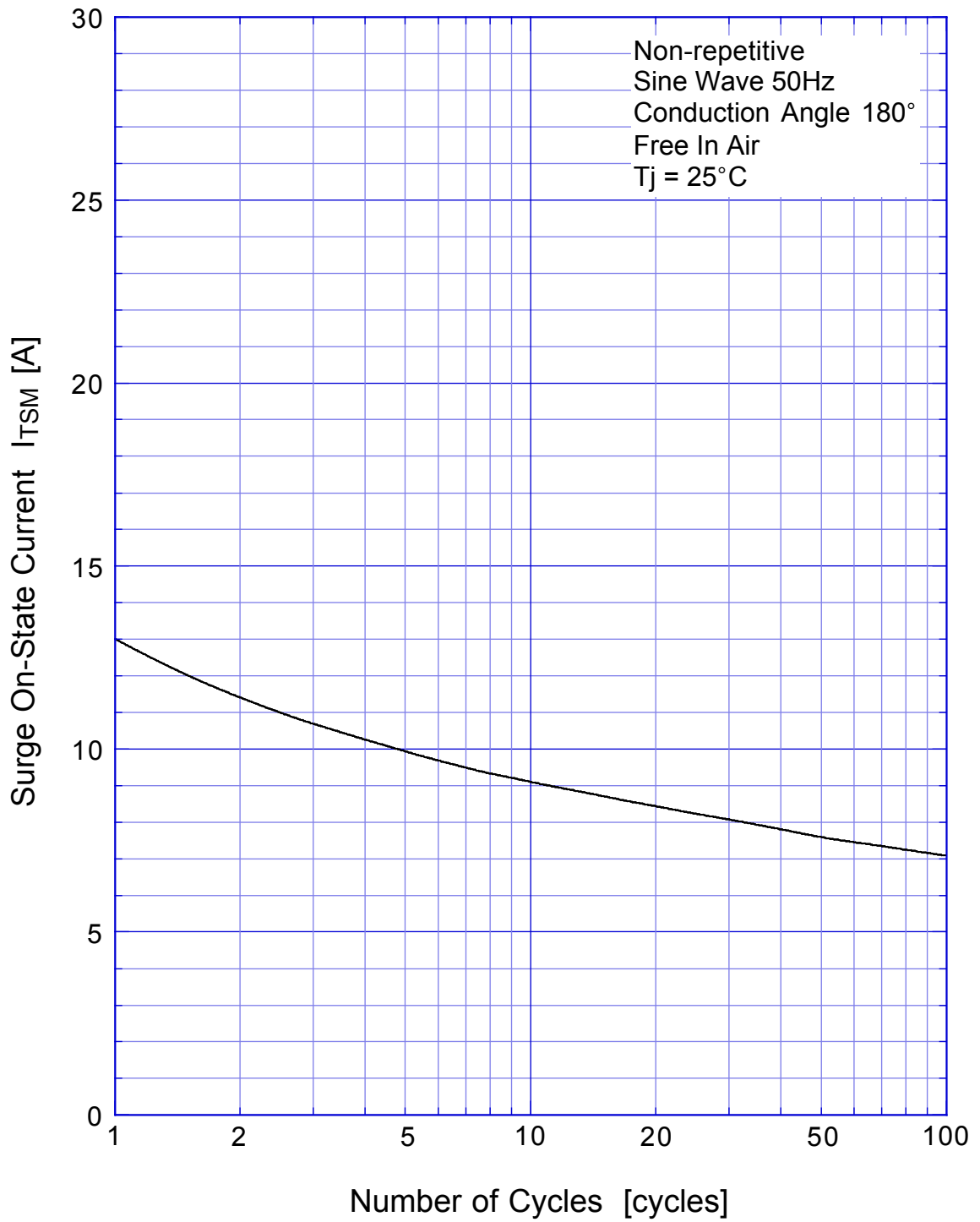

K1V33(W)
K1V34(W)
K1V36(W)
K1V38(W)

Pulse On-State Current Rating

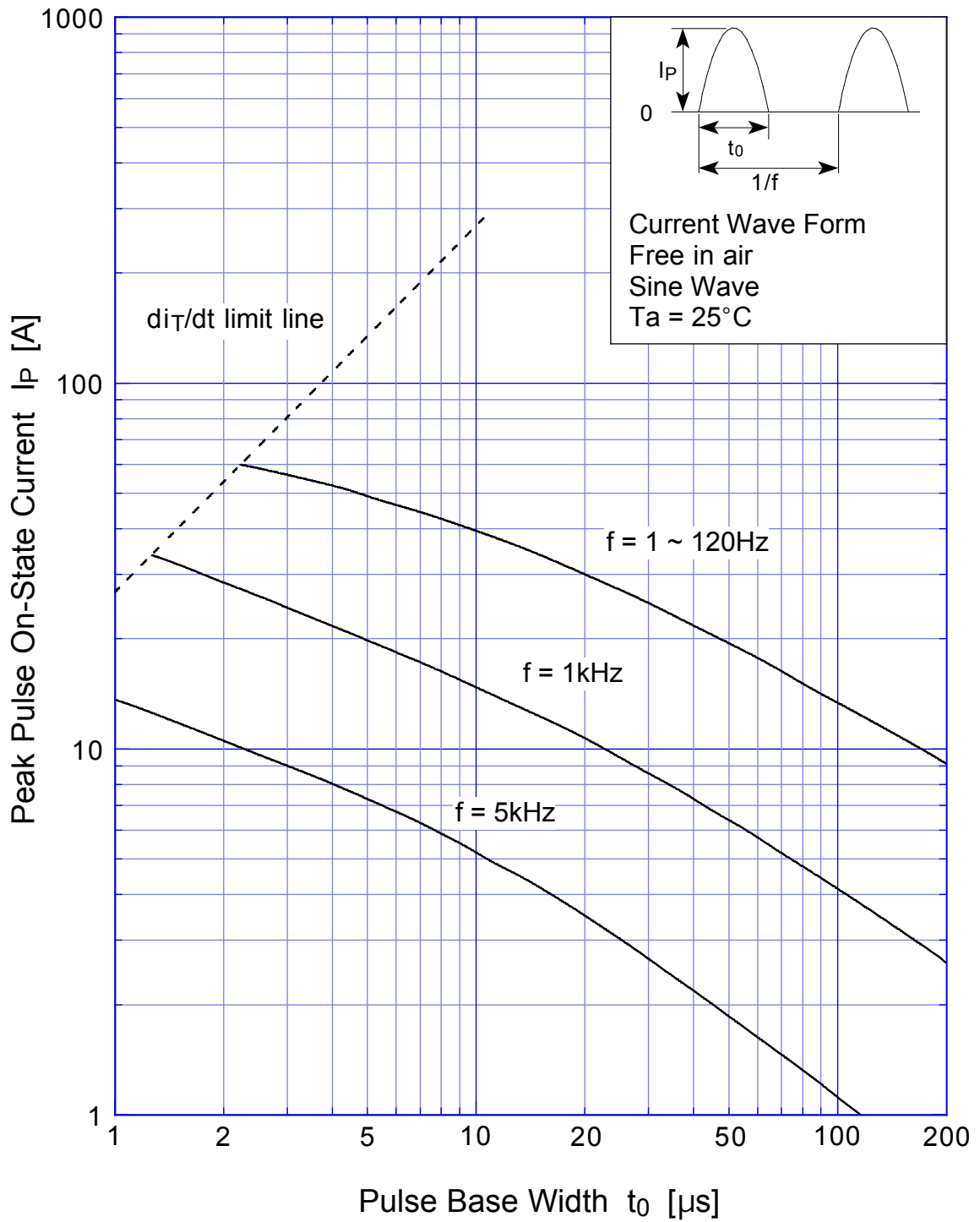

K1V33(W)

K1V34(W)

K1V36(W)

K1V38(W)

Pulse On-State Current Derating

