

### Typical Applications

The HMC-C022 Wideband LNA is ideal for:

- Telecom Infrastructure
- Microwave Radio & VSAT
- Military & Space
- Test Instrumentation
- Fiber Optics

### Functional Diagram

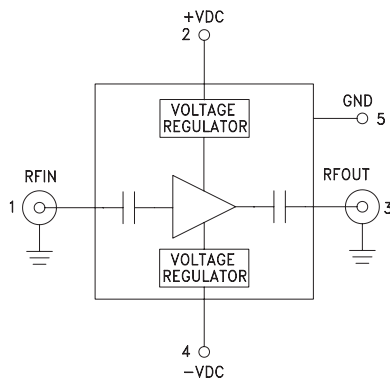

### Features

- Noise Figure: 2 dB @ 8 GHz
- Flat Gain: 14 dB  $\pm$  0.5 dB
- P1dB Output Power: +18 dBm @ 8 GHz
- Spurious-Free Operation
- Regulated Supply and Bias Sequencing
- Hermetically Sealed Module
- Field Replaceable SMA connectors
- 55 to +85°C Operating Temperature

### General Description

The HMC-C022 is a GaAs MMIC PHEMT Low Noise Distributed Amplifier in a miniature, hermetic module with replaceable SMA connectors which operates between 2 and 20 GHz. The amplifier provides 14 dB of gain, 2 to 3 dB noise figure and up to +18 dBm of output power at 1 dB gain compression. Gain flatness is excellent from 2 - 18 GHz making the HMC-C022 ideal for EW, ECM RADAR and test equipment applications. The wideband amplifier I/Os are internally matched to 50 Ohms and are internally DC blocked. Integrated voltage regulators allow for flexible biasing of both the negative and positive supply pins, while internal bias sequencing circuitry assures robust operation.

### Electrical Specifications, $T_A = +25^\circ \text{C}$ , +VDC = +8V to +16V, -VDC = -3V to -12V

Parameter	Min.	Typ.	Max.	Min.	Typ.	Max.	Min.	Typ.	Max.	Units
Frequency Range	2.0 - 6.0			6.0 - 12.0			12.0 - 20.0			GHz
Gain	12	15		11	14		10	13		dB
Gain Flatness		$\pm 0.25$			$\pm 0.5$			$\pm 0.5$		dB
Gain Variation Over Temperature		0.008	0.015		0.008	0.015		0.008	0.015	dB/°C
Noise Figure		2.5	4.5		2.0	3.0		3.0	5.0	dB
Input Return Loss		17			17			18		dB
Output Return Loss		13			15			8		dB
Output Power for 1 dB Compression (P1dB)	15	18		13	16		9	13		dBm
Saturated Output Power (Psat)		22			21			19		dBm
Output Third Order Intercept (IP3)		28			27			23		dBm
Positive Supply Current (+IDC)		75			75			75		mA
Negative Supply Current (-IDC)		1.8			1.8			1.8		mA

**Gain & Return Loss**

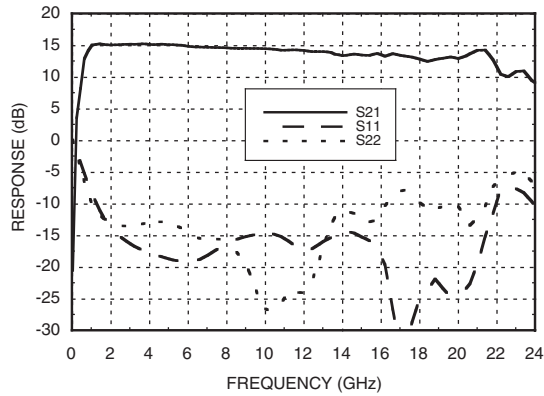

**Gain vs. Temperature**

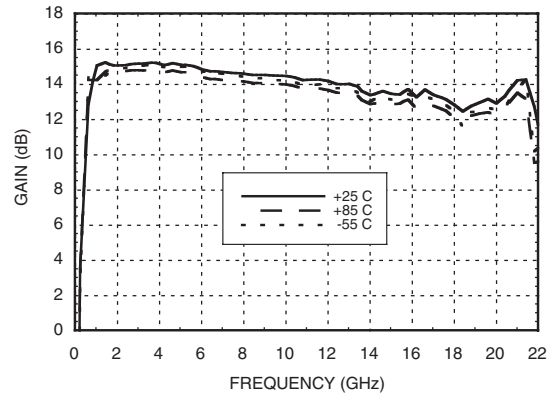

**Input Return Loss vs. Temperature**

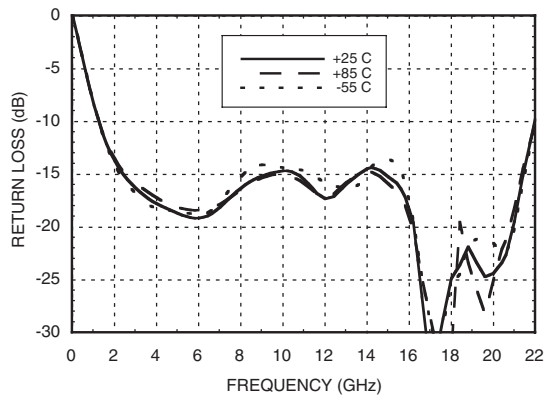

**Output Return Loss vs. Temperature**

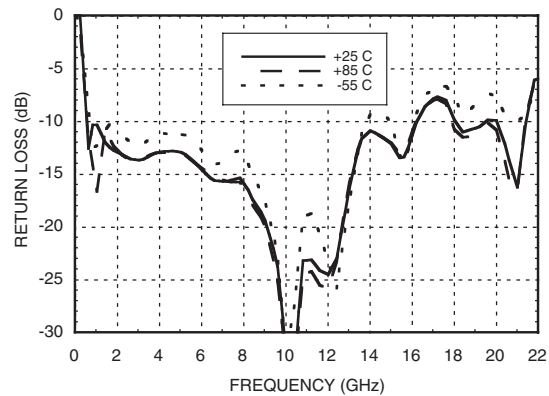

**Reverse Isolation vs. Temperature**

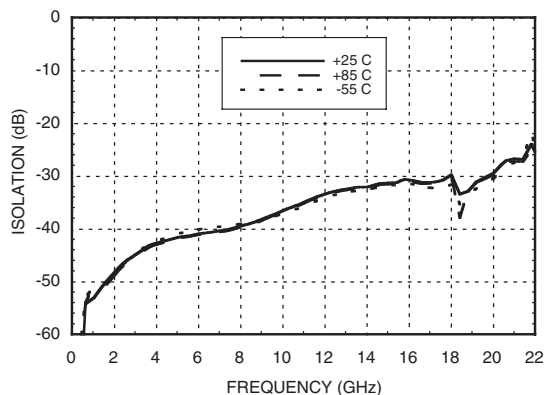

**Noise Figure vs. Temperature**

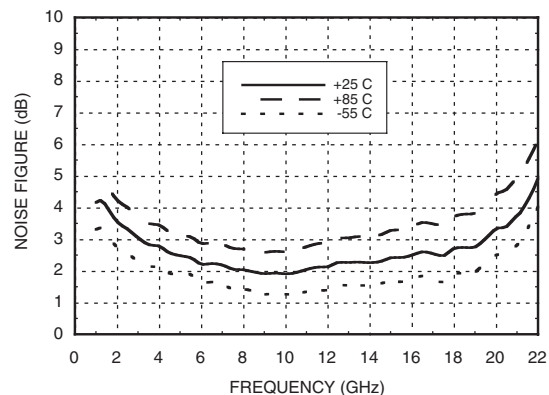

**P1dB vs. Temperature**

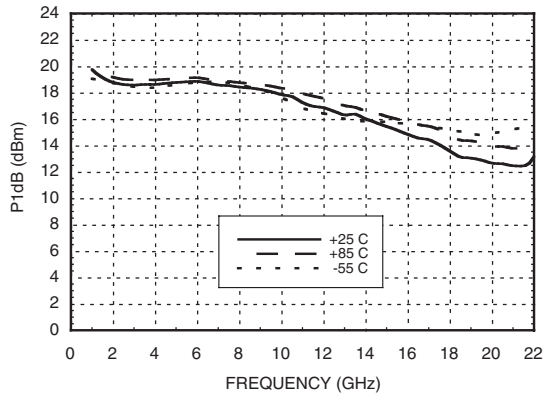

**Psat vs. Temperature**

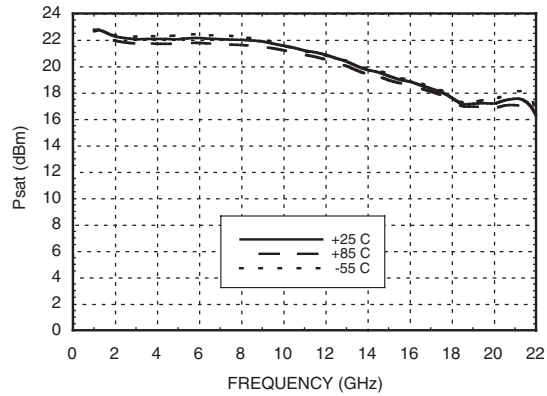

**Output IP3 vs. Temperature**

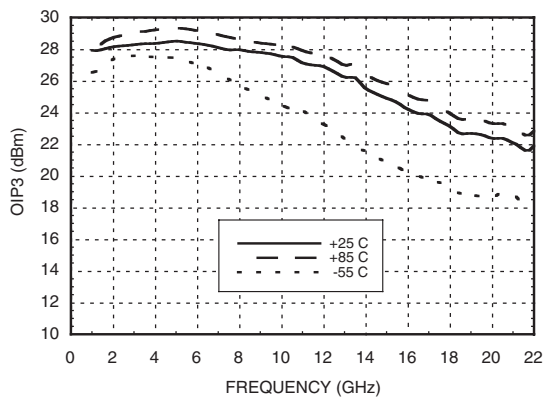



**Absolute Maximum Ratings**

Positive Bias Supply Voltage (+VDC)	+17V Max
Negative Bias Supply (-VDC)	-16V Min.
RF Input Power (RFIn)	+23 dBm
Storage Temperature	-65 to +150 °C
Operating Temperature	-55 to +85 °C

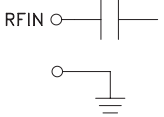
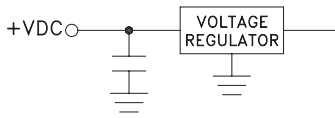
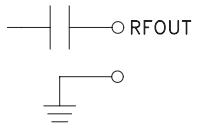
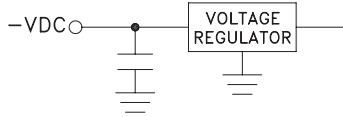

**ELECTROSTATIC SENSITIVE DEVICE  
OBSERVE HANDLING PRECAUTIONS**

**Pin Descriptions**

Pin Number	Function	Description	Interface Schematic
1	RFIN & RF Ground	RF input connector, SMA female, field replaceable. This pin is AC coupled and matched to 50 Ohms from 2 - 20 GHz.	
2	+VDC	Positive power supply voltage for the amplifier.	
3	RFOUT & RF Ground	RF output connector, SMA female. This pin is AC coupled and matched to 50 Ohms from 2 - 20 GHz.	
4	-VDC	Negative power supply voltage for the amplifier	
5	GND	Power supply ground.	

### Outline Drawing

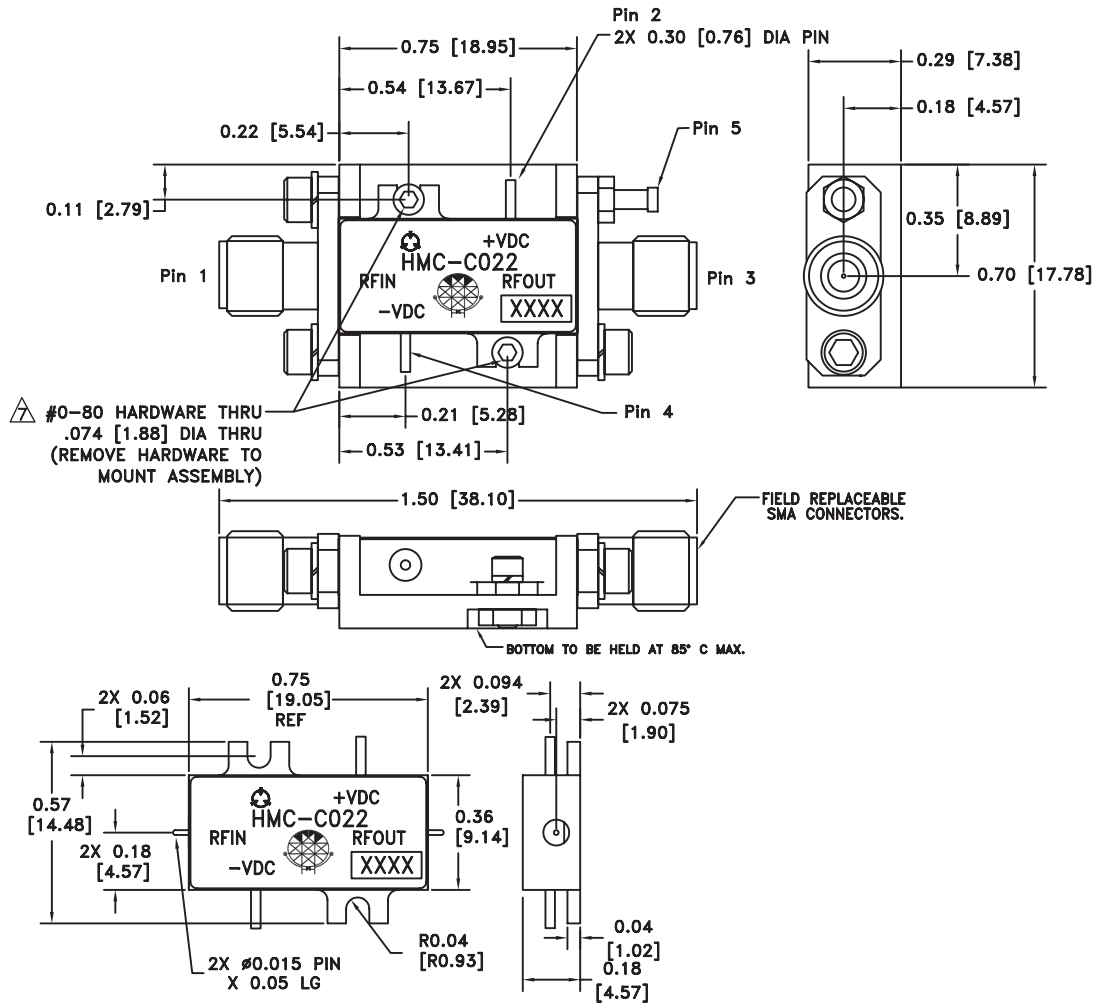

NOTES:

1. PACKAGE, LEADS, COVER MATERIAL: KOVAR™
2. SPACER MATERIAL: ALUMINUM
3. PLATING: ELECTROLYTIC GOLD 50 MICROINCHES MIN., OVER ELECTROLYTIC NICKEL 75 MICROINCHES MIN.
4. ALL DIMENSIONS ARE IN INCHES [MILLIMETERS].
5. TOLERANCES ±.005 [0.13] UNLESS OTHERWISE SPECIFIED.
6. FIELD REPLACEABLE SMA CONNECTORS. TENSOLITE 5602 - 5CCSF OR EQUIVALENT.

△ TO MOUNT MODULE TO SYSTEM PLATFORM REPLACE 0 - 80 HARDWARE WITH DESIRED MOUNTING SCREWS.

**Notes:**