

REPETITIVE AVALANCHE AND dv/dt RATED HEXFET[®] TRANSISTORS THRU-HOLE (TO-205AF)

IRFF310
JANTX2N6786
JANTXV2N6786
REF:MIL-PRF-19500/556
400V, N-CHANNEL

Product Summary

Part Number	BVDSS	RDS(on)	ID
IRFF310	400V	3.6Ω	1.25A

The HEXFET[®] technology is the key to International Rectifier's advanced line of power MOSFET transistors. The efficient geometry and unique processing of this latest "State of the Art" design achieves: very low on-state resistance combined with high transconductance.

The HEXFET transistors also feature all of the well established advantages of MOSFETs such as voltage control, very fast switching, ease of paralleling and temperature stability of the electrical parameters. They are well suited for applications such as switching power supplies, motor controls, inverters, choppers, audio amplifiers and high energy pulse circuits.

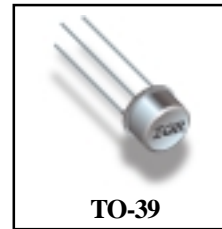

TO-39

Features:

- Repetitive Avalanche Ratings
- Dynamic dv/dt Rating
- Hermetically Sealed
- Simple Drive Requirements
- Ease of Paralleling

Absolute Maximum Ratings

	Parameter		Units
ID @ VGS = 10V, TC = 25°C	Continuous Drain Current	1.25	A
ID @ VGS = 10V, TC = 100°C	Continuous Drain Current	0.80	
IDM	Pulsed Drain Current ①	5.5	
PD @ TC = 25°C	Max. Power Dissipation	15	W
	Linear Derating Factor	0.12	W/°C
VGS	Gate-to-Source Voltage	±20	V
EAS	Single Pulse Avalanche Energy ②	0.82	mJ
IAR	Avalanche Current ①	—	A
EAR	Repetitive Avalanche Energy ①	—	mJ
dv/dt	Peak Diode Recovery dv/dt ③	4.0	V/ns
TJ	Operating Junction	-55 to 150	°C
TSTG	Storage Temperature Range		
	Lead Temperature	300 (0.063 in. (1.6mm) from case for 10s)	
	Weight	0.98(typical)	g

For footnotes refer to the last page

Electrical Characteristics @ T_j = 25°C (Unless Otherwise Specified)

	Parameter	Min	Typ	Max	Units	Test Conditions
BV _{DSS}	Drain-to-Source Breakdown Voltage	400	—	—	V	V _{GS} = 0V, I _D = 1.0mA
ΔBV _{DSS} /ΔT _J	Temperature Coefficient of Breakdown Voltage	—	0.37	—	V/°C	Reference to 25°C, I _D = 1.0mA
R _{DS(on)}	Static Drain-to-Source On-State Resistance	—	—	3.6	Ω	V _{GS} = 10V, I _D = 0.80A ④
		—	—	4.15		V _{GS} = 10V, I _D = 1.25A ④
V _{GS(th)}	Gate Threshold Voltage	2.0	—	4.0	V	V _{DS} = V _{GS} , I _D = 250μA
g _{fs}	Forward Transconductance	0.7	—	—	S (Ω)	V _{DS} > 15V, I _{DS} = 0.80A ④
I _{DSS}	Zero Gate Voltage Drain Current	—	—	25	μA	V _{DS} = 320V, V _{GS} = 0V
		—	—	250		V _{DS} = 320V V _{GS} = 0V, T _J = 125°C
I _{GSS}	Gate-to-Source Leakage Forward	—	—	100	nA	V _{GS} = 20V
I _{GSS}	Gate-to-Source Leakage Reverse	—	—	-100		V _{GS} = -20V
Q _g	Total Gate Charge	6.7	—	8.4	nC	V _{GS} = 10V, I _D = 1.25A
Q _{gs}	Gate-to-Source Charge	0.2	—	1.5		V _{DS} = 200V
Q _{gd}	Gate-to-Drain ('Miller') Charge	3.5	—	5.0		
t _{d(on)}	Turn-On Delay Time	—	—	15	ns	V _{DD} = 200V, I _D = 1.25A, R _G = 7.5Ω
t _r	Rise Time	—	—	20		
t _{d(off)}	Turn-Off Delay Time	—	—	35		
t _f	Fall Time	—	—	30		
L _S + L _D	Total Inductance	—	7.0	—	nH	Measured from drain lead (6mm/0.25in. from package) to source lead (6mm/0.25in. from package)
C _{iss}	Input Capacitance	—	170	—	pF	V _{GS} = 0V, V _{DS} = 25V f = 1.0MHz
C _{oss}	Output Capacitance	—	49	—		
C _{rss}	Reverse Transfer Capacitance	—	10	—		

Source-Drain Diode Ratings and Characteristics

	Parameter	Min	Typ	Max	Units	Test Conditions
I _S	Continuous Source Current (Body Diode)	—	—	1.25	A	T _j = 25°C, I _S = 1.25A, V _{GS} = 0V ④
I _{SM}	Pulse Source Current (Body Diode) ①	—	—	5.5		
V _{SD}	Diode Forward Voltage	—	—	1.4	V	T _j = 25°C, I _F = 1.25A, di/dt ≤ 100A/μs V _{DD} ≤ 50V ④
t _{rr}	Reverse Recovery Time	—	—	540	nS	
Q _{RR}	Reverse Recovery Charge	—	—	4.5	μC	
t _{on}	Forward Turn-On Time	Intrinsic turn-on time is negligible. Turn-on speed is substantially controlled by L _S + L _D .				

Thermal Resistance

	Parameter	Min	Typ	Max	Units	Test Conditions
R _{thJC}	Junction-to-Case	—	—	8.3	°C/W	Typical socket mount.
R _{thJA}	Junction-to-Ambient	—	—	175		

Note: Corresponding Spice and Saber models are available on the G&S Website.

For footnotes refer to the last page

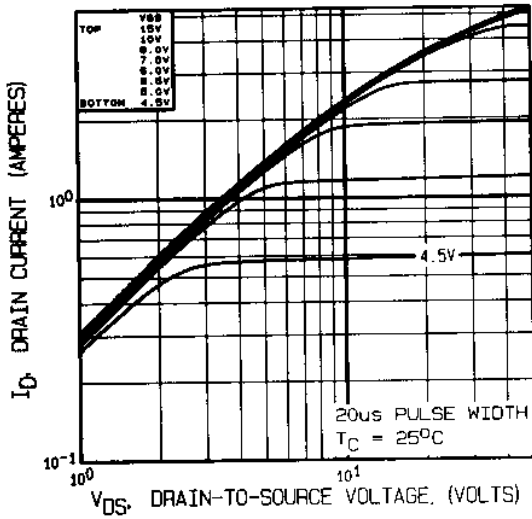

Fig 1. Typical Output Characteristics

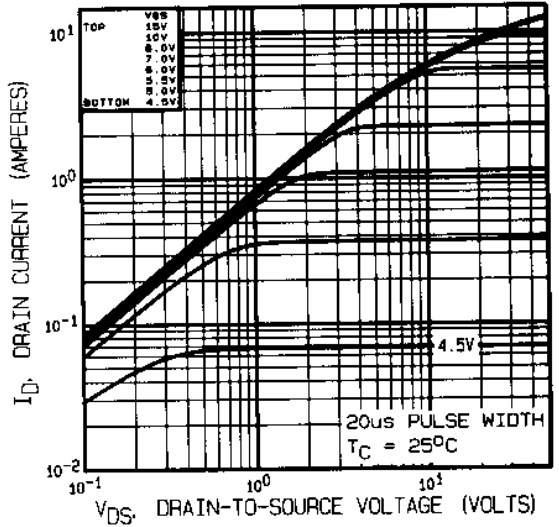

Fig 2. Typical Output Characteristics

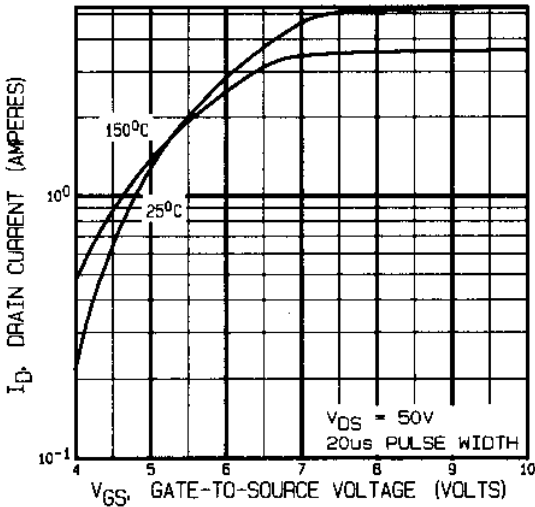

Fig 3. Typical Transfer Characteristics

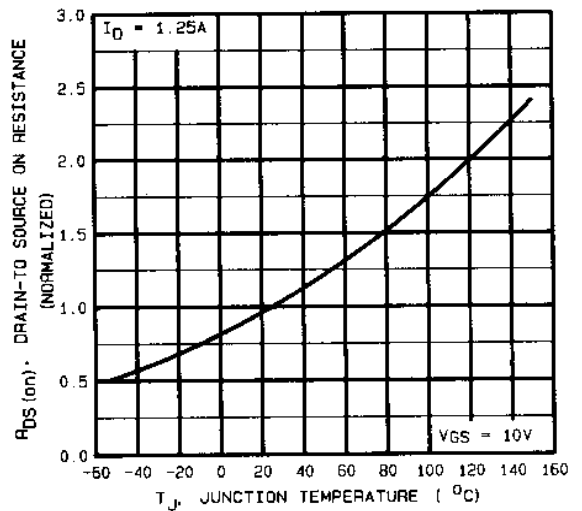

Fig 4. Normalized On-Resistance Vs. Temperature

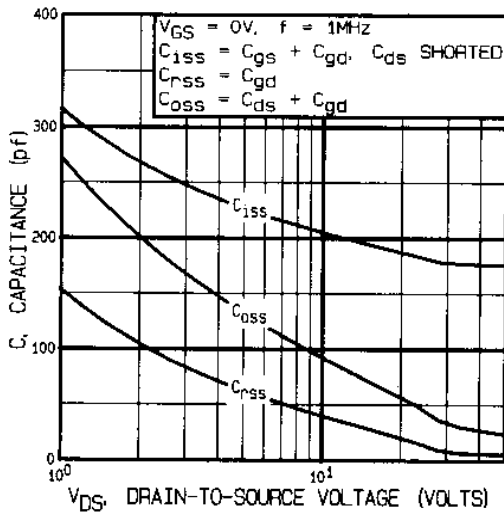

Fig 5. Typical Capacitance Vs. Drain-to-Source Voltage

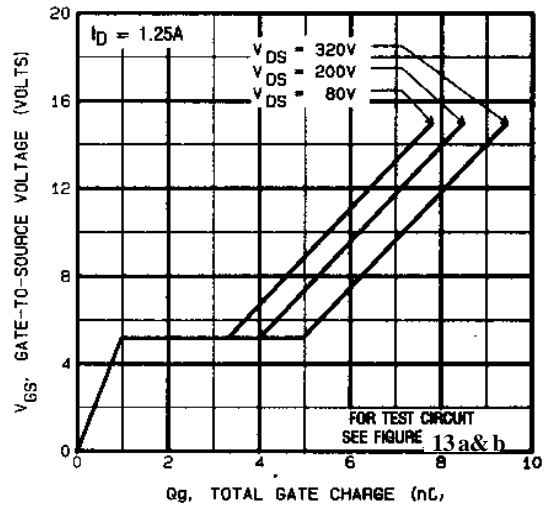

Fig 6. Typical Gate Charge Vs. Gate-to-Source Voltage

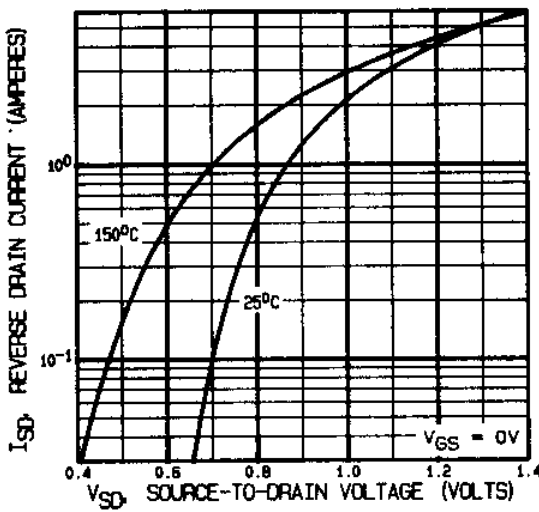

Fig 7. Typical Source-Drain Diode Forward Voltage

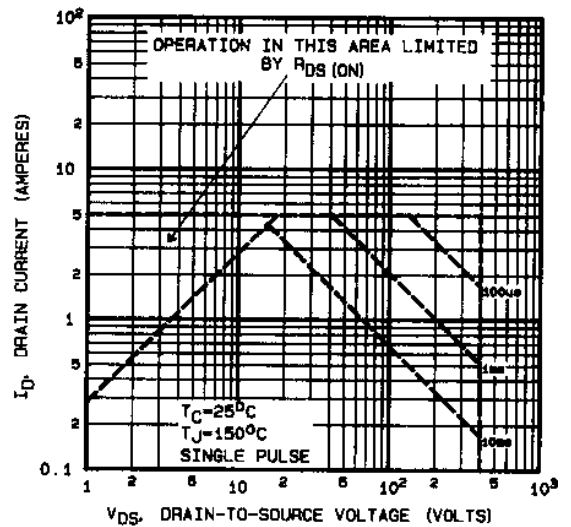

Fig 8. Maximum Safe Operating Area

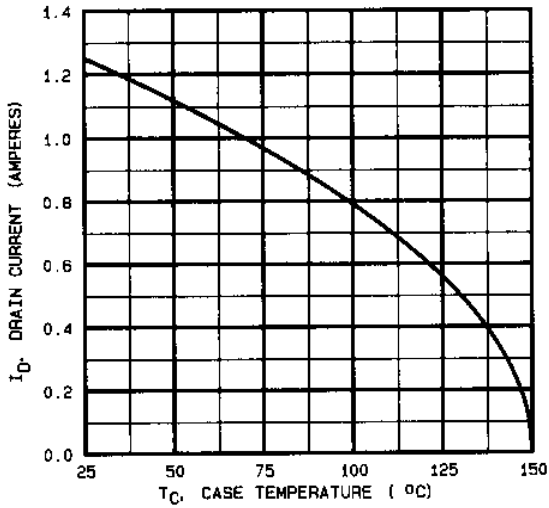

Fig9. Maximum Drain Current Vs. Case Temperature

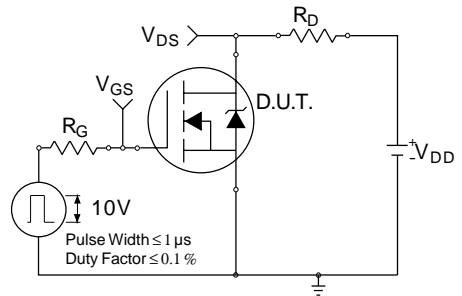

Fig 10a. Switching Time Test Circuit

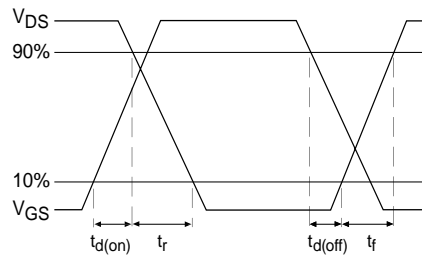

Fig 10b. Switching Time Waveforms

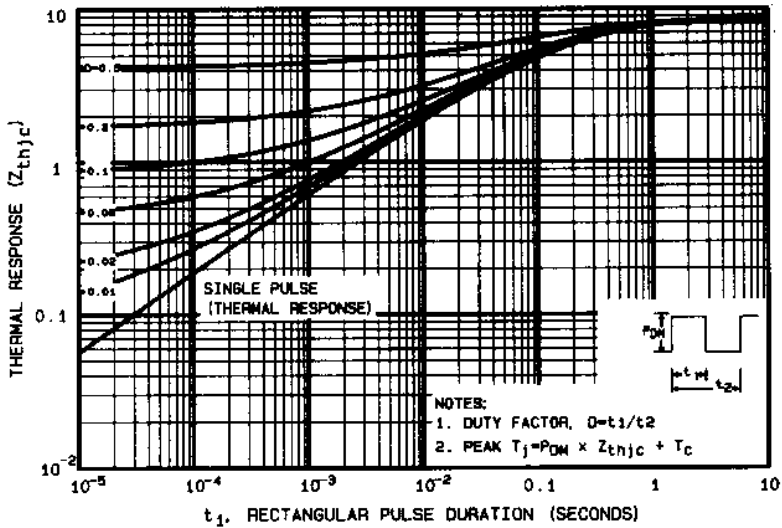

Fig 11. Maximum Effective Transient Thermal Impedance, Junction-to-Case

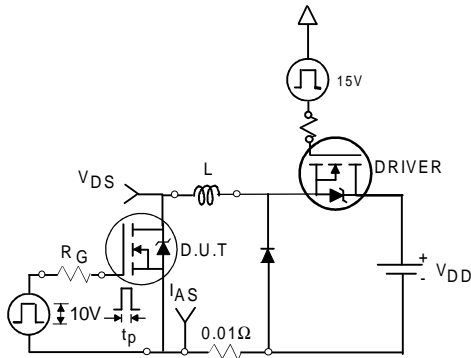

Fig 12a. Unclamped Inductive Test Circuit

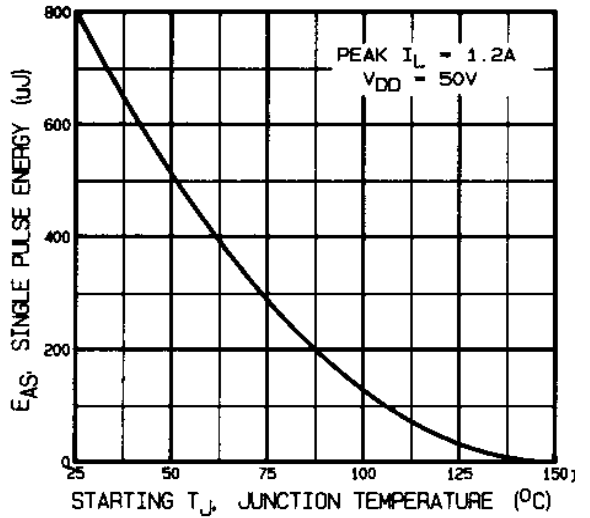

Fig 12c. Maximum Avalanche Energy Vs. Drain Current

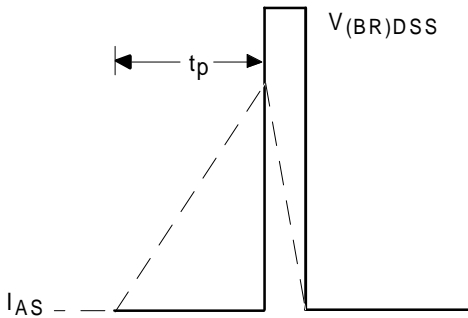

Fig 12b. Unclamped Inductive Waveforms

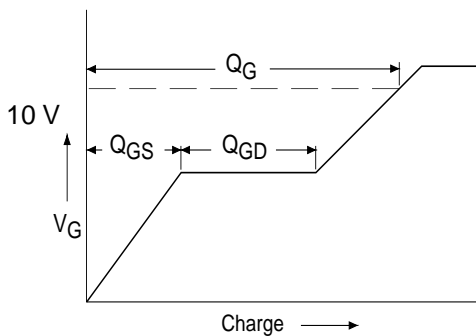

Fig 13a. Basic Gate Charge Waveform

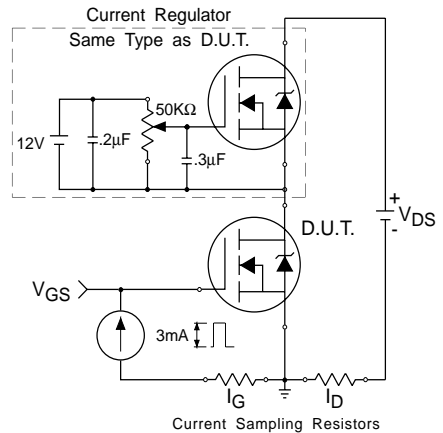
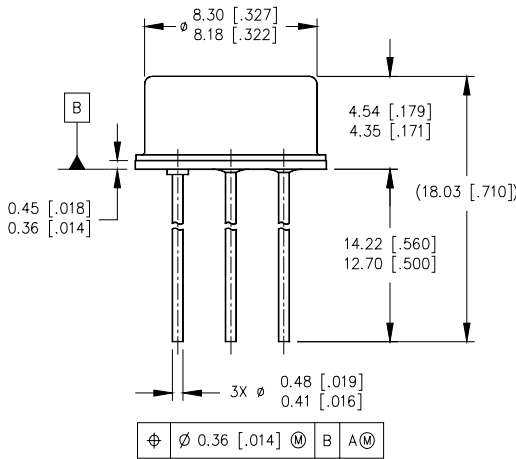

Fig 13b. Gate Charge Test Circuit

Foot Notes:

- ① Repetitive Rating; Pulse width limited by maximum junction temperature.
- ② $V_{DD} = 50V$, starting $T_J = 25^\circ C$,
Peak $I_L = 1.25A$,
- ③ $I_{SD} \leq 1.25A$, $di/dt \leq 40A/\mu s$,
 $V_{DD} \leq 400V$, $T_J \leq 150^\circ C$
Suggested $R_G = 7.5 \Omega$
- ④ Pulse width $\leq 300 \mu s$; Duty Cycle $\leq 2\%$

Case Outline and Dimensions —TO-205AF



SIDE VIEW

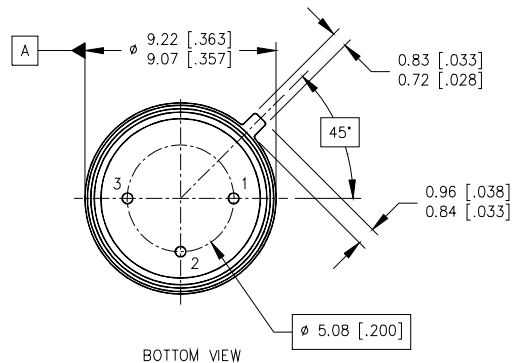

BOTTOM VIEW

NOTES:

- 1. DIMENSIONING AND TOLERANCING PER ASME 14.5M-1994.
- 2. DIMENSIONS ARE SHOWN IN MILLIMETERS [INCHES].
- 3. CONTROLLING DIMENSION: INCH.
- 4. CONFORMS TO JEDEC OUTLINE TO-205AF (TO-39).

LEGEND

- 1- SOURCE
- 2- GATE
- 3- DRAIN