



# **AN220E04 Datasheet**

## **Dynamically Reconfigurable FPAA**



[www.anadigm.com](http://www.anadigm.com)

## Disclaimer

Anadigm reserves the right to make any changes without further notice to any products herein. Anadigm makes no warranty, representation or guarantee regarding the suitability of its products for any particular purpose, nor does Anadigm assume any liability arising out of the application or use of any product or circuit, and specifically disclaims any and all liability, including with out limitation consequential or incidental damages. "Typical" parameters can and do vary in different applications. All operating parameters, including "Typicals" must be validated for each customer application by customer's technical experts. Anadigm does not in this document convey any license under its patent rights nor the rights of others. Anadigm software and associated products cannot be used except strictly in accordance with an Anadigm software license. The terms of the appropriate Anadigm software license shall prevail over the above terms to the extent of any inconsistency.

© Anadigm<sup>®</sup> Ltd. 2003  
© Anadigm<sup>®</sup>, Inc. 2003  
All Rights Reserved.

# AN220E04 Datasheet – Dynamically Reconfigurable FPAA

## PRODUCT AND ARCHITECTURE OVERVIEW

The AN220E04 is the first member of Anadigm’s second generation FPAA family – the Anadigmvortex family. Based on a fully differential switched-capacitor architecture, this new product family features higher bandwidth, improved total harmonic distortion (THD) and the ability to implement a host of advanced functions.

The AN220E04 consists of a 2 x 2 matrix of fully configurable switched capacitor configurable analog blocks (CABs), enmeshed in a fabric of programmable interconnect resources. These programmable features are directed by an on-chip SRAM configuration memory. The four CABs have access to a single Look-Up Table (LUT) which can be used to implement non linear functions such as user-defined input-to-output transfer functions, and arbitrary signal waveform generation.

Analog input signals come in from the outside world via the four input cells. The fourth input cell of the AN220E04 has a special ‘multiplexing’ feature which allows the connection of up to four unique signal sources. An input cell can accept either a single-ended signal or a differential signal pair. The input cells each have built-in programmable anti-aliasing filters, as well as a high gain amplifier which has an optional chopper stabilized operating mode designed for use with signals requiring significant gain and hence ultra low input offset voltages.

The AN220E04 is also designed to support dynamic reconfiguration. There are two memories on the AN220E04:

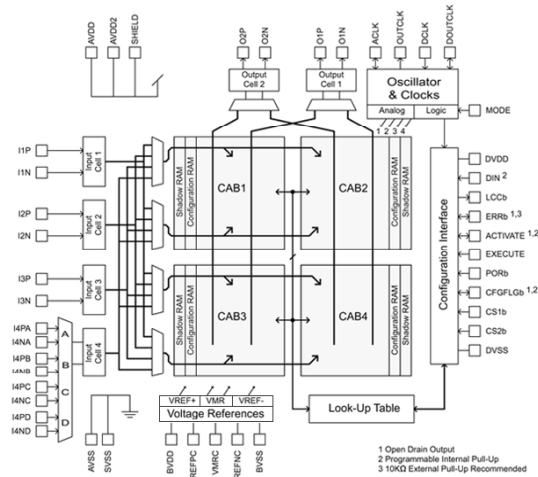

Figure 1: Architectural overview of the AN220E04 device

Shadow SRAM and Configuration SRAM. The new reconfiguration data is stored in the Shadow SRAM, which can then be transferred to the Configuration SRAM at just a single clock edge providing for synchronized on-the-fly update of the analog circuit function.

## PRODUCT FEATURES

- Dynamic reconfiguration
- Fully differential architecture
- Fully differential I/O buffering with options for single ended to differential conversion
- Low input offset through chopper stabilized amplifiers
- Built-in Successive Approximation Register (SAR)
- 256 Byte Look-Up Table (LUT) for linearization and arbitrary signal generation
- 4:1 Input multiplexer
- Typical Signal Bandwidth: DC-2MHz (Bandwidth is CAM dependent)
- Signal to Noise Ratio:
  - Broadband 80dB
  - Narrowband (audio) 100dB
- Total Harmonic Distortion (THD): 80dB
- DC offset <100µV
- Package: 44-pin QFP (10x10x2mm)
  - Lead pitch 0.8mm
- Supply voltage: 5V

## ORDERING CODES

AN220E04-QFPSP	Dynamically reconfigurable FPAA Sample Pack
AN220E04-QFPTY	Dynamically reconfigurable FPAA Tray (96 pcs)
AN220E04-QFPTR	Dynamically reconfigurable FPAA Tape & Reel (1000 pcs)
AN220D04-EVAL	AN220E04 Evaluation Kit
AN220D04-DEVLP	AN220E04 Development Kit

## APPLICATIONS

- Real-time software control of analog system peripherals
- Intelligent sensors
- Adaptive filtering and control
- Adaptive DSP front-end
- Adaptive industrial control and automation
- Self-calibrating systems
- Compensation for aging of system components
- Dynamic recalibration of remote systems
- Ultra-low frequency signal conditioning
- Custom analog signal processing

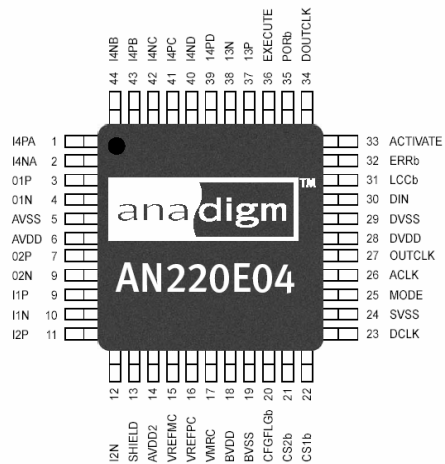

[For more detailed information on the features of the AN220E04 device, please refer to the AN120E04/AN220E04 User Manual]

## AN220E04 Datasheet – Dynamically Reconfigurable FPA

### ELECTRICAL CHARACTERISTICS

#### Absolute Maximum Ratings

Parameter	Symbol	Min	Typ	Max	Unit	Comment
DC Power Supplies	AVDD(2) BVDD DVDD	-0.5	-	5.5 V	V	AVSS, BVSS, DVSS and SVSS all held to 0.0 V <sup>a</sup>
xVDD to xVDD Offset		-0.5		0.5	V	Ideally all supplies should be at the same voltage
Package Power Dissipation	Pmax 25°C Pmax 85°C	-	-	1.8 0.73	W	Still air, No heatsink, 4 layer board, 44 pins. $\theta_{ja} = 55^{\circ}\text{C/W}$
Analog and Digital Input Voltage	Vinmax	Vss-0.5	-	Vdd+0.5	V	
Ambient Operating Temperature	Top	-40	-	85	°C	
Storage Temperature	Tstg	-65		150	°C	

<sup>a</sup> Absolute Maximum DC Power Supply Rating - The failure mode is non-catastrophic for Vdd of up to 7 volts, but will cause reduced operating life time. The additional stress caused by higher local electric fields within the CMOS circuitry may induce metal migration, oxide leakage and other time/quality related issues.

#### Recommended Operating Conditions

Parameter	Symbol	Min	Typ	Max	Unit	Comment
DC Power Supplies	AVDD(2) BVDD DVDD	4.75	5.00	5.25	V	AVSS, BVSS, DVSS and SVSS all held to 0 V
Analog Input Voltage.	Vina	VMR-1.9	-	VMR+1.9	V	VMR is 2.0 volts above AVSS
Digital Input Voltage	Vind	0	-	DVDD	V	
Junction Temp	Tj	-40	-	125	°C	Assume a package $\theta_{ja} = 55^{\circ}\text{C/W}$ <sup>b</sup>

<sup>b</sup> In order to calculate the junction temperature you must first empirically determine the current draw (total Idd) for the design. Once the current consumption established then the following formula can be used;  $T_j = T_a + I_{dd} \times V_{dd} \times 55^{\circ}\text{C/W}$ , where  $T_a$  is the ambient temperature. The worst case  $\theta_{ja}$  of 55 °C/W assumes no air flow and no additional heatsink of any type.

#### General Digital I/O Characteristics (Vdd = 5v +/- 10%, -40 to 85 deg.C)

Parameter	Symbol	Min	Typ	Max	Unit	Comment
Input Voltage Low	Vih	0	-	30	-	% of DVDD
Input Voltage High	Vil	70	-	100	-	% of DVDD
Output Voltage Low	Vol	0	-	20	-	% of DVDD
Output Voltage High	Voh	80	-	100	-	% of DVDD
Input Leakage Current	Iil	-	-	±1.0	µA	All pins except DCLK
Input Leakage Current	Iil	-	±12.0	-	µA	DCLK if a crystal is connected and the on-chip oscillator is used
Max. Capacitive Load	Cmax	-	-	10	pF	The maximum load for a digital output is 10 pF // 10 Kohm
Min. Resistive Load	Rmin	10	-	-	Kohm	The maximum load for a digital output is 10 pF // 10 Kohm
DCLK Frequency	Fmax	-	-	40	MHz	For MODE = 1, Max DCLK is 16 MHz
ACLK Frequency	Fmax	-	-	40	MHz	Divide down to <8 MHz prior to use as a CAB clock
Clock Duty Cycle	-	45	-	55	%	All clocks

## AN220E04 Datasheet – Dynamically Reconfigurable FPAA

Detailed Digital I/O Interface Characteristics: Vdd = 5.0volts

### LCCb

Parameter	Symbol	Min	Typ	Max	Unit	Comment
Output Voltage Low	V <sub>ol</sub>	V <sub>ss</sub>	-	150	mV	Load 20pF//50Kohm to V <sub>ss</sub>
Output Voltage High	V <sub>oh</sub>	4.5	-	V <sub>dd</sub>	V	Load 20pF//50Kohm to V <sub>ss</sub>
Max. Capacitive Load	C <sub>max</sub>	-	-	20	pF	Maximum load 20 pF // 50 Kohm
Min. Resistive Load	R <sub>min</sub>	50	-	-	Kohm	Maximum load 20 pF // 50 Kohm
Current Sink	I <sub>snkmax</sub>	-	-	15	mA	LCCb pin shorted to V <sub>dd</sub>
Current Source	I <sub>srcmax</sub>	-	-	4	mA	LCCb pin shorted to V <sub>ss</sub>

### CFGFLG, ACTIVATE

Parameter	Symbol	Min	Typ	Max	Unit	Comment
Input Voltage Low	V <sub>il</sub>	0		30	%	% of DVDD
Input Voltage High	V <sub>ih</sub>	70		100	%	% of DVDD
Output Voltage Low	V <sub>ol</sub>	V <sub>ss</sub>	-	85	mV	Pin load = Internal pullup + 20pF//50K to V <sub>ss</sub>
Output Voltage High	V <sub>oh</sub>	4.5	-	V <sub>dd</sub>	V	Pin load = Internal pullup + 20pF//50K to V <sub>ss</sub>
Output Voltage Low	V <sub>ol</sub>	V <sub>ss</sub>	-	200	mV	Pin Load = External 5K ohm pullup + 20pF//50K to V <sub>ss</sub>
Output Voltage High	V <sub>oh</sub>	4.5	-	V <sub>dd</sub>	V	Pin Load = External 5Kohm pullup + 20pF//50K to V <sub>ss</sub>
Max. Capacitive Load	C <sub>max</sub>	-	-	50	pF	Maximum load 50 pF // 50 Kohm
Min. Resistive Load	R <sub>min</sub>	50	-	-	Kohm	Maximum load 50 pF // 50 Kohm
Current Sink	I <sub>snkmax</sub>	-	-	2.5	mA	Pin shorted to V <sub>dd</sub>
Current Source	I <sub>srcmax</sub>	-	-	200	μA	Pin shorted to V <sub>ss</sub>
External Resistive Pullup	R <sub>pullupext</sub>	5	7.5	10	Kohm	Use only if internal pullup is deselected

### ERRb

Parameter	Symbol	Min	Typ	Max	Unit	Comment
Input Voltage Low	V <sub>il</sub>	0		30	%	% of DVDD
Input Voltage High	V <sub>ih</sub>	70		100	%	% of DVDD
Output Voltage Low	V <sub>ol</sub>	V <sub>ss</sub>	-	50	mV	
Output Voltage High	V <sub>oh</sub>	4.9	-	V <sub>dd</sub>	V	
Max. Capacitive Load	C <sub>max</sub>	-	-	50	pF	Maximum load 50 pF // 50 Kohm
Min. Resistive Load	R <sub>min</sub>	50	-	-	Kohm	Maximum load 50 pF // 50 Kohm
Current Sink	I <sub>snkmax</sub>	-	-	10	mA	
Current Source	I <sub>srcmax</sub>	-	-	0	μA	
External Resistive Pullup	R <sub>pullupext</sub>	10	10	10	Kohm	

### DCLK, Mode, DIN, EXECUTE, PORb, CS1b, CS2b

Parameter	Symbol	Min	Typ	Max	Unit	Comment
Input Voltage Low	V <sub>il</sub>	0	-	30	%	% of DVDD
Input Voltage High	V <sub>ih</sub>	70	-	100	%	% of DVDD

## AN220E04 Datasheet – Dynamically Reconfigurable FPAA

### OUTCLK/SPIMEM,DOUTCLK

Parameter	Symbol	Min	Typ	Max	Unit	Comment
Output Voltage Low	V <sub>ol</sub>	0	-	20	%	% of DVDD
Output Voltage High	V <sub>oh</sub>	80	-	100	%	% of DVDD
Max. Capacitive Load	C <sub>max</sub>	-	-	50	pF	Maximum load 50 pF // 50 Kohm
Min. Resistive Load	R <sub>min</sub>	10	-	-	Kohm	Maximum load 50 pF // 50 Kohm
Current Sink	I <sub>snkmax</sub>	-	-	17	mA	
Current Source	I <sub>srcmax</sub>	-	-	4	mA	

### ACLK/SPIP

Parameter	Symbol	Min	Typ	Max	Unit	Comment
Input Voltage Low	V <sub>il</sub>	0	-	30	%	% of DVDD
Input Voltage High	V <sub>ih</sub>	70	-	100	%	% of DVDD
Output Voltage Low	V <sub>ol</sub>	0	-	20	%	% of DVDD
Output Voltage High	V <sub>oh</sub>	80	-	100	%	% of DVDD
Max. Capacitive Load	C <sub>max</sub>	-	-	50	pF	Maximum load 50 pF // 50 Kohm
Min. Resistive Load	R <sub>min</sub>	10	-	-	Kohm	Maximum load 50 pF // 50 Kohm
Current Sink	I <sub>snkmax</sub>	-	-	15	mA	
Current Source	I <sub>srcmax</sub>	-	-	4	mA	

## AN220E04 Datasheet – Dynamically Reconfigurable FPAA

### Analog Inputs General

Parameter	Symbol	Min	Typ	Max	Unit	Comment
High Precision Input Range <sup>c</sup>	V <sub>ina</sub>	0.5	-	3.5	V	VMR +/- 1.5v
Standard precision Input Range <sup>d</sup>	V <sub>ina</sub>	0.1	-	3.9	V	VMR +/- 1.9v
High Precision Differential Input <sup>c</sup>	V <sub>diffina</sub>	0	-	+/-3.0	V	Common mode voltage = 2 V
Standard Precision Differential Input <sup>d</sup>	V <sub>diffina</sub>	0	-	+/-3.8	V	Common mode voltage = 2 V
Common Mode Input Range	V <sub>cm</sub>	1.8	2.0	2.2	V	
Input Offset	V <sub>os</sub>	-	5	15	mV	Non-chopper stabilized input
Input Frequency	F <sub>ain</sub>	0	<2	8	MHz	Max value is clock, CAM and input stage dependant. Input frequency is limited to approx <2MHz due to CAM signal processing which is based on sampled data architectures.

<sup>c</sup>. High precision operating range provides optimal linearity and dynamic range.

<sup>d</sup>. Standard precision operating range provides maximum dynamic range and reduced linearity.

### Input Differential Amplifier ON and filter OFF

Parameter	Symbol	Min	Typ	Max	Unit	Comment
Input Range	V <sub>ina</sub> V <sub>diffina</sub>	See analog input above				Usable input range will be reduced by the effective gain setting
Gain Setting	G <sub>inamp</sub>	16	-	128		
Gain Accuracy		-	1.0	2.5	%	
Gain Drift (Temperature, Supply Voltage and Time)	Dist	-	-	1.0	%	
Equivalent Input Offset Voltage	V <sub>os</sub>	-	3	12	mV	Non-chopper stabilized input When the input amplifier and filter are used in combination V <sub>os</sub> contribution comes only from the input amplifier
Offset Voltage Temperature Coefficient	V <sub>offsettc</sub>	-	1	10	μV/°C	from -40°C to 125°C
Input Frequency <sup>c</sup>	F <sub>ain</sub>	0	-	2	MHz	
Input Frequency <sup>d</sup>	F <sub>ain</sub>	0	<2	8	MHz	
Power Supply Rejection Ratio	PSRR	65	-	-	dB	d.c. Amp Gain =16 a.c. See graphs page 18
Common Mode Rejection Ratio	CMRR	-	67	-	dB	
Large Signal Harmonic Distortion	Dist	-	-65	-	dB	0.4v p-p Differential input at 660Hz Gain setting = 16
Input Resistance	R <sub>in</sub>	10		-	Mohm	
Input Capacitance	C <sub>in</sub>	-		5.0	pF	
Input Referred Noise Figure	NF	-	0.1	-	μV/sqrtHz	Input cell Gain = 16 Applies to audio frequency range (400Hz to 30KHz). See graphical data on page 18
Signal-to Noise Ratio and Distortion	SINAD	-	75	-	dB	Input signal = 285 mV p-p diff, audio frequency range See graphical data on page 18
Spurious Free Dynamic Range	SFDR	-	73	-	dB	Input signal = 100 mV p-p diff See graphical data on page 18

<sup>c</sup>. High precision operating range provides optimal linearity and dynamic range.

<sup>d</sup>. Standard precision operating range provides maximum dynamic range and reduced linearity.

## AN220E04 Datasheet – Dynamically Reconfigurable FPAA

### Input Differential Chopper Amplifier ON and Filter OFF

Parameter	Symbol	Min	Typ	Max	Unit	Comment
Input Range	V <sub>ina</sub> V <sub>difffina</sub>	See analog input above				Usable input range will be reduced by the effective gain setting
Gain Setting	G <sub>inamp</sub>	16	-	128		
Gain Accuracy		-	1.0	2.5	%	
Gain Drift, (Temperature, Supply Voltage and Time)		-	-	1.0	%	
Chopper Frequency Clock Range	F <sub>ch</sub>	F <sub>c</sub> /260100	-	>250	KHz	F <sub>c</sub> = master clock frequency Set F <sub>ch</sub> as slow as possible F <sub>ch</sub> > 250KHz will result in some signal attenuation
Equivalent Input Offset Voltage	V <sub>os</sub>	-	<100	200	μV	Chopper stabilized amplifier The maximum value of 200μV is guaranteed by production test This is a tester limitation
Offset Voltage Temperature Coefficient	V <sub>offsettc</sub>	-	0.5	2.0	μV/°C	from -40°C to 125°C
Power Supply Rejection Ratio	PSRR	65	-	-	dB	d.c. a.c. See graphs on page 18
Common Mode Rejection Ratio	CMRR	-	102	-	dB	
Large Signal Harmonic Distortion	Dist	-	-40	-	dB	0.4v p-p Differential input at 660Hz Gain setting = 16
Input Frequency	F <sub>ain</sub>	0	F <sub>ch</sub> /20	F <sub>ch</sub> /2	KHz	F <sub>ch</sub> =Chopper clock frequency The chopper frequency and input frequency should be chosen such that subsequent low pass filtering can remove the chopper stage frequency elements
Input Resistance	R <sub>in</sub>	10		-	Mohm	Input to filter or chopper
Input Capacitance	C <sub>in</sub>	-		5.0	pF	
Input Referred Noise Figure	NF	-	0.09	-	μV/sqrtHz	Input cell Gain = 16 Applies to Audio frequency range Chopper clock F <sub>ch</sub> = 250KHz See graphical data on page 18
Signal-to Noise Ratio and Distortion	SINAD	-	75	-	dB	Input signal = 285 mV p-p differential, Audio frequency range See graphical data on page 18
Spurious Free Dynamic Range	SFDR	-	74	-	dB	Input signal =100 mV p-p differential See graphical data on page 18

### Input Differential Amplifier OFF and Filter ON

Parameter	Symbol	Min	Typ	Max	Unit	Comment
Input Range	V <sub>ina</sub> V <sub>difffina</sub>	See analog input above				
Equivalent Input Offset	V <sub>os</sub>	-	8	32	mV	Non-chopper stabilized input, Filter corner frequency =470KHz
Offset Voltage Temperature Coefficient	V <sub>offsettc</sub>	-	0.05 <sup>I</sup>	1.0 <sup>II</sup>	mV/°C	from -40°C to 125°C I. measured at filter corner=470KHz II. maximum at Filter corner=76KHz
Input Frequency	F <sub>ain</sub>	-	-	-	MHz	Input filter frequency will define the maximum frequency Input filter is recommended to be >30x higher than the max input frequency, for 80dB distortion performance



## AN220E04 Datasheet – Dynamically Reconfigurable FPAA

Common Mode Rejection Ratio	CMRR	-	60	-	dB	
Power Supply Rejection Ratio	PSRR	68	-	-	dB	d.c. a.c. See graphical data on page 19
Large Signal Harmonic Distortion	Dist	-	-82	-	dB	4v p-p Differential input at 660Hz Filter corner frequency 470KHz
Input Low Pass Filter (Anti-Alias) Corner Frequency Settings	Ffiltcorner	76	-	470	KHz	
Input Resistance	Rin	10	-	-	Mohm	Input to filter or chopper
Input Capacitance	Cin	-	-	5.0	pF	
Input Referred Noise Figure	NF	-	0.17	-	μV/sqrtHz	Input cell filter corner Fc = 470KHz Applies to Audio frequency range See graphical data on page 18
Signal-To Noise Ratio and Distortion	SINAD	-	84	-	dB	Input signal = 1400 mV p-p diff, Audio frequency range See graphical data on page 18
Spurious Free Dynamic Range	SFDR	-	90	-	dB	Input signal =1400 mV p-p differential See graphical data on page 18

### Input Differential Voltage mode, Amplifier OFF, Filter OFF and Unity Gain Stage ON

Parameter	Symbol	Min	Typ	Max	Unit	Comment
Input Range	Vina Vdiffina	See analog input above			V	
Equivalent Input Offset	Vos	-	5	15	mV	Non-chopper stabilized input
Offset Voltage Temperature Coefficient	Voffsettc	-	20	50	μV/°C	from -40°C to 125°C
Input Frequency	Fain	-	-	1.0	MHz	Gain Bandwidth limited by input impedance
Power Supply Rejection Ratio	PSRR	60	-	-	dB	d.c. a.c. See graphs on page 18
Common Mode Rejection Ratio	CMRR	-	60	-	dB	
Large Signal Harmonic Distortion	Dist	-	-80	-	dB	4v p-p Differential input at 660Hz
Large Signal Harmonic Distortion	Dist	-	-80	-	dB	3v p-p single ended signal at 660Hz
Input Resistance	Rin	-	126	-	Kohm	Input to unity gain stage
Input Capacitance	Cin	-	2.0	5.0	pF	
Input Referred Noise Figure	NF	-	0.16	-	μV/sqrtHz	Applies to Audio frequency range See graphical data on page 18
Signal-To Noise Ratio and Distortion	SINAD	-	84	-	dB	Input signal = 1400 mV p-p diff, Audio frequency range See graphical data on page 18
Spurious Free Dynamic Range	SFDR	-	90	-	dB	Input signal =1400 mV p-p differential See graphical data on page 18

### Input Differential Voltage mode, Amplifier OFF, Filter OFF and Unity Gain stage OFF

Parameter	Symbol	Min	Typ	Max	Unit	Comment
Input Range	Vina Vdiffina	See analog input above			V	
Equivalent Input Offset	Vos	N/A	N/A	N/A	mV	See CAM Op Amp
Offset Voltage Temperature Coefficient	Voffsettc	N/A	N/A	N/A	μV/°C	See CAM Op Amp. from -40°C to 125°C
Input Frequency	Fain	-	-	8	MHz	Dependant upon CAM
Power Supply Rejection Ratio	PSRR	N/A	N/A	N/A	dB	See CAM Op Amp
Large Signal Harmonic Distortion	Dist	-	-85	-	dB	See CAM Op Amp
Input Resistance	Rin	-	-	-	Mohm	Input to CAM directly (Input cell bypass mode). This variable is influenced by CAB capacitor size, CAB clock frequency and CAB architecture
Input Capacitance	Cin	-	-	-	pF	Input to CAM directly (Input cell bypass mode) This variable is influenced by CAB capacitor size, CAB clock frequency and CAB architecture

## AN220E04 Datasheet – Dynamically Reconfigurable FPAA

### Analog Outputs

(See "Output Cell" section in the AN120E04/AN220E04 user manual for more details)

Parameter	Symbol	Min	Typ	Max	Unit	Comment
High Precision Output Range <sup>c</sup>	Vouta	0.5	-	3.5	V	VMR +/- 1.5v
Standard Precision Output Range <sup>d</sup>	Vouta	0.1	-	3.9	V	VMR +/- 1.9v
High Precision Differential Output <sup>c</sup>	Vdiffouta	-	-	+/-3.0	V	Common mode voltage = 2 V
Standard precision Differential Output <sup>d</sup>	Vdiffouta	-	-	+/-3.8	V	Common mode voltage = 2 V
Common Mode Voltage	Vcm	1.9	2.0	2.1	V	

<sup>c</sup>. High precision operating range provides optimal linearity and dynamic range.

<sup>d</sup>. Standard precision operating range provides maximum dynamic range and reduced linearity.

### Output Voltage mode and filter ON, corner frequency 470KHz

Parameter	Symbol	Min	Typ	Max	Unit	Comment
Input Range	Vina Vdiffina	See analog input above			V	
Equivalent Input Offset	Vos	-	5	15	mV	
Offset Voltage Temperature Coefficient	Voffsettc		0.05 <sup>l</sup>	1.0 <sup>ll</sup>	mV/°C	from -40°C to 125°C <sup>l</sup> measured at filter corner: 470KHz <sup>ll</sup> maximum at filter corner: 76KHz
Output Frequency	Faout	-	-	-	MHz	Output filter frequency will define the maximum frequency Input filter is recommended to be >30x higher than the max input frequency, for good distortion performance
Power Supply Rejection Ratio	PSRR	60	-	-	dB	d.c. a.c. See graphical data on page 19
Large Signal Harmonic Distortion	Dist	-	-82	-	dB	4v p-p Differential input at 660Hz Filter corner frequency 470KHz
Input Low Pass Filter (Anti-Alias) Corner Frequency Settings	Ffiltcorner	76	-	470	KHz	
Output Load <sup>c,e</sup>	Rload	0.1	-	-	Mohm	
Output Load <sup>c,e</sup>	Cload	-	-	50	pF	
Output Load <sup>d,e</sup>	Rload	1	10	-	Kohm	Additional loading causes internal voltage drops across output stage and series resistances The output stage has a small signal output impedance of approx 10ohm
Output Load <sup>d,e</sup>	Cload	-	-	100	pF	
Common Mode Rejection Ratio	CMRR	-	56	-	dB	
Input Referred Noise Figure	NF	-	0.22	-	µV/sqrtHz	Output filter corner fc = 470KHz Applies to Audio frequency range See graphical data on page 18
Signal-To Noise Ratio and Distortion	SINAD	-	82	-	dB	Input signal = 1400 mV p-p diff, Audio frequency range See graphical data on page 18
Spurious Free Dynamic Range	SFDR	-	90	-	dB	Input signal =1400 mV p-p diff See graphical data on page 18

<sup>c</sup>. High precision operating range provides optimal linearity and dynamic range.

<sup>d</sup>. Standard precision operating range provides maximum dynamic range and reduced linearity.

<sup>e</sup>. The maximum load for an analog output is 50 pF // 100 Kohms. This load maybe with respect to analog ground VMR or AVSS.

## AN220E04 Datasheet – Dynamically Reconfigurable FPAA

### Output Voltage mode and filter off (bypass mode)

Parameter	Symbol	Min	Typ	Max	Unit	Comment
Input Range	V <sub>ina</sub> V <sub>dif</sub> fina	See analog input above			V	
Equivalent Input Offset	V <sub>os</sub>	N/A	N/A	N/A	mV	See CAM Op Amp
Offset Voltage Temperature Coefficient	V <sub>offset</sub> c	N/A	N/A	N/A	mV/°C	See CAM Op Amp
Output Frequency <sup>c e</sup>	F <sub>out</sub>	-	-	4	MHz	
Output Frequency <sup>d f</sup>	F <sub>out</sub>	-	-	8	MHz	The realizable output frequency is limited to approx <2MHz due to CAM signal processing which is based on sampled data architectures.
Power Supply Rejection Ratio	PSRR	N/A	N/A	N/A	dB	See CAM Op Amp
Large Signal Harmonic Distortion	Dist	-	-85	-	dB	
Output Load	R <sub>load</sub>	N/A	N/A	N/A	Mohm	See CAM Op Amp
Output Load	C <sub>load</sub>	N/A	N/A	N/A	pF	See CAM Op Amp

<sup>c</sup>. High precision operating range provides optimal linearity and dynamic range.

<sup>d</sup>. Standard precision operating range provides maximum dynamic range and reduced linearity.

<sup>e</sup>. The maximum load for an analog output is 50 pF // 100 Kohms. This load maybe with respect to analog ground VMR or AVSS.

<sup>f</sup>. The maximum load for an analog output is 100 pF // 100 Kohms. This load must be differential and with respect to analog ground(VMR).

### VMR (voltage Mid Rail) and VREF (Reference Voltage) Ratings

Parameter	Symbol	Min	Typ	Max	Unit	Comment
VMR Output Voltage	V <sub>vmr</sub>	1.925	2.01	2.075	V	At 25°C, V <sub>dd</sub> =5.00 volts
VREF+ Output Voltage	V <sub>ref+</sub>	3.4	3.51	3.6	V	At 25°C, V <sub>dd</sub> =5.00 volts
VREF- Output Voltage	V <sub>ref-</sub>	0.45	0.505	0.55	V	At 25°C, V <sub>dd</sub> =5.00 volts
Output Voltage Deviation VREF+, VMR, VREF-	V <sub>refout</sub>	-	0.5	1	%	Over process and supply voltage corners
Voltage Temperature Coefficient VREF+, VMR, VREF-	V <sub>reftc</sub>	-	-	-	-	See typical graphical data below -40°C to 125°C <sup>f</sup>
Power Supply Rejection Ratio, VMR	PSSR	60	-	-	dB	
Power Supply Rejection Ratio Vref+ and Vref-	PSSR	75	-	-	dB	
Start Up Time	T <sub>start</sub>	-	-	1	ms	Assuming recommended capacitors

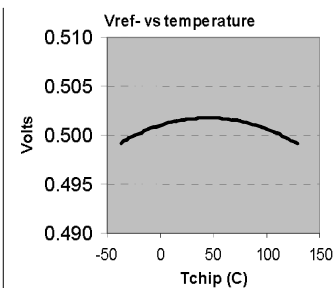
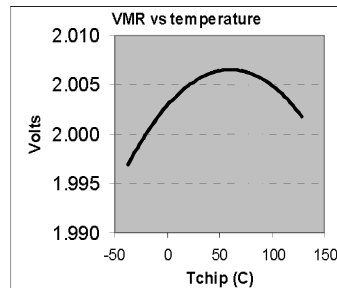
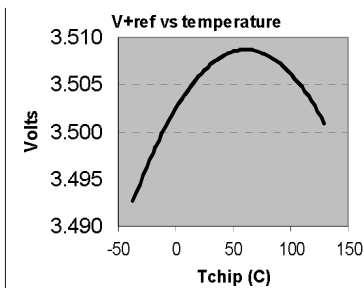

## AN220E04 Datasheet – Dynamically Reconfigurable FPAA

### CAB (Configurable Analog Block) Differential Operational Amplifier

Parameter	Symbol	Min	Typ	Max	Unit	Comment
High Precision Input/Output Range <sup>c</sup>	Vinouta	0.5	-	3.5	V	VMR +/- 1.5v
Standard Precision Input/Output Range <sup>d</sup>	Vinouta	0.1	-	3.9	V	VMR +/-1.9v
High Precision Differential Input/Output <sup>c</sup>	Vdiffioa	-	-	+/-3.0	V	Common mode voltage = 2 V
Standard Precision Differential Input/Output <sup>d</sup>	Vdiffioa	-	-	+/-3.8	V	Common mode voltage = 2 V
Common Mode Input Voltage Range <sup>d</sup>	Vcm	0	2.0	4	V	
Common Mode Output Voltage Range	Vcm	1.9	2.0	2.1	V	
Equivalent Input Voltage Offset.	Voffset	0.1	5	15	mV	Some CAMs (Configurable Analog Modules) can inherently compensate
Offset Voltage Temperature Coefficient	Voffsettc	-	1	10	µV/°C	from -40°C to 125°C some CAMs (Configurable Analog Modules) can inherently compensate
Power Supply Rejection Ratio	PSSR	-	80	-	dB	Variation between CAMs is expected because of variations in architecture
Common Mode Rejection Ratio	CMRR	-	77	-	dB	Example 1 <b>GainInv CAM</b> CAM clock = 1MHz CAM parameter settings Gain = 1
Common Mode Rejection Ratio	CMRR	-	60	-	dB	Example 2 <b>Filterbiquad</b> Setting = Low pass filter CAM clock = 1MHz CAM parameter settings Gain = 1, Corner frequency = 50KHz Quality Factor = 0.707
Differential Slew Rate, Internal	Slew	-	50	-	V/µsec	Applicable when the OpAmp load is internal to the FPAA
Differential Slew Rate, External	Slew	-	10	-	V/µsec	Applicable when the OpAmp driving signal out of the FPAA package
Unity Gain Bandwidth, Full Power Mode.	UGB	-	50	-	MHz	Applicable when sourcing and loading the OpAmp with a load internal to the FPAA
Input Impedance, Internal	Rin	10	-	-	Mohm	
Output Impedance, Internal	Rout	-	-	-	Ohms	The OpAmp output is designed to drive all internal nodes, these are dominantly capacitive loads
Output Impedance, External	Rout	-	-	-	Ohms	Output to an FPAA output pin (output cell bypass mode). This variable is influenced by CAB capacitor size, CAB clock frequency and CAB architecture
Output Load, External <sup>c e</sup>	Rload	0.1	-	-	Mohm	
Output Load, External <sup>c e</sup>	Cload	-	-	50	pF	
Output Load, External <sup>d e f</sup>	Rload	1	10	-	Kohm	Additional loading causes internal voltage drops across output stage and series resistances The output stage has a small signal output impedance of approx 10ohm
Output Load, External <sup>d e f</sup>	Cload	-	-	50	pF	
Noise Figure <sup>g</sup>	Noise	-	0.13	-	µV/sqrtHz	Example1 <b>GainInv CAM</b> CAM clock = 1MHz Gain = 1

## AN220E04 Datasheet – Dynamically Reconfigurable FPAA

Signal-To Noise Ratio and Distortion <sup>g</sup>	SINAD	-	80	-	dB	Input signal=1400 mV p-p differential Audio frequency range Example. <b>GainInv CAM</b> CAM clock = 1MHz Gain = 1
Spurious Free Dynamic Range <sup>g</sup>	SFDR	-	92	-	dB	Input signal=1400 mV p-p differential, Audio frequency range Example. <b>GainInv CAM</b> CAM clock = 1MHz Gain = 1

- <sup>c</sup>. High precision operating range provides optimal linearity and dynamic range.
- <sup>d</sup>. Standard precision operating range provides maximum dynamic range and reduced linearity.
- <sup>e</sup>. The maximum load for an analog output is 50 pF || 100 Kohms. This load may be with respect to analog ground VMR or AVSS.
- <sup>f</sup>. Using the FPAA with CAB Op Amp's driving directly off-chip, requires care, full characterization of the performance of each application circuit by the circuit designer is necessary.
- <sup>g</sup>. This specification parameter can only be characterized when a circuit topology is configured onto the CAB differential amplifier architecture. The figure provided here is an representative on the performance of one specific CAM, as specified in the comments.

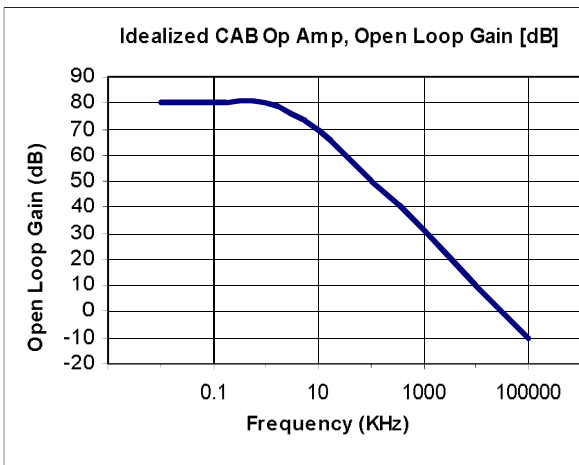

The idealized open loop gain plot is provided for information only. This information is associated with the FPAA in full power mode of operation. The FPAA operation amplifier open loop gain cannot be observed nor used when associated with external connections to the device. Internal reprogrammable routing impedances and switched capacitor circuit architecture using this operational amplifier limit the effective usable bandwidth of a circuit realized in the FPAA to less than 2MHz.

## AN220E04 Datasheet – Dynamically Reconfigurable FPAA

### CAB (Configurable Analog Block) Differential Comparator

Parameter	Symbol	Min	Typ	Max	Unit	Comment
Input Range, Internal	V <sub>ina</sub>	0.1	-	3.9	V	
Input Range, External	V <sub>ina</sub>	0.0	-	V <sub>dd</sub>	V	
Differential Input, Internal	V <sub>diffina</sub>	-	-	+/-3.8	V	Common mode voltage = 2 V
Differential Input, External	V <sub>diffina</sub>	+/- 0.0	-	+/- V <sub>dd</sub>	V	
Common Mode Output Voltage Range, Internal <sup>c</sup>	V <sub>cm</sub>	1.9	2.0	2.1	V	
Common Mode Input Voltage Range, External <sup>c</sup>	V <sub>cm</sub>	0	2.0	4	V	
Common Mode Input Voltage, External <sup>d</sup>	V <sub>cm</sub>	0	-	5	V	The comparator will function correctly
Differential Output	V <sub>outdiff</sub>	-	-	+/-5	V	
Single Pin Output (Ox1P)	V <sub>out</sub>	0	-	5	V	
Input Voltage Offset	V <sub>offcomp</sub>	-	2	10	mV	Zero hysteresis
Offset Voltage Temperature Coefficient	V <sub>offsettc</sub>	-	1	10	μV/°C	from -40°C to 125°C, Zero Hysteresis
Setup Time, Internal	T <sub>setint</sub>	-	-	125	nsec	
Setup Time, External	T <sub>setext</sub>	-	-	500	nsec	
Delay Time	T <sub>delay</sub>	½T <sub>d</sub> +25	-	1½T <sub>d</sub> +25	nsec	T <sub>d</sub> = 1/F <sub>c</sub> F <sub>c</sub> = master clock frequency
Output Load	R <sub>load</sub>	10	-	-	Kohm	Applies if comparator drive off chip with output cell in bypass mode
Output Load	C <sub>load</sub>	-	-	50	pF	Applies if comparator drive off chip with output cell in bypass mode
Differential Variable Reference Voltage Settings	CompV <sub>ref</sub>	0	-	+/-4.0	V	
Differential Hysteresis	Hysta1	-	V <sub>offcomp</sub>	-	mV	Hysteresis setting = zero
Differential Hysteresis	Hysta2	-	20	-	mV	Hysteresis setting = 10mV
Differential Hysteresis	Hysta3	-	40	-	mV	Hysteresis setting = 20mV
Differential Hysteresis	Hysta4	-	80	-	mV	Hysteresis setting = 40mV
Hysteresis Setting Accuracy	Hystb	-	25	-	%	
Hysteresis Temperature Coefficient	Hysttc1	-	5	-	μV/°C	Hysteresis setting = zero
Hysteresis Temperature Coefficient	Hysttc2	-	50	-	μV/°C	Hysteresis setting = 10mV
Hysteresis Temperature Coefficient	Hysttc3	-	100	-	μV/°C	Hysteresis setting = 20mV
Hysteresis Temperature Coefficient	Hysttc4	-	200	-	μV/°C	Hysteresis setting = 40mV

<sup>c</sup> High precision operating range provides optimal linearity and dynamic range.

<sup>d</sup> Standard precision operating range provides maximum dynamic range and reduced linearity.

# AN220E04 Datasheet – Dynamically Reconfigurable FPAA

## ESD Characteristics

Pin Type	Human Body Model	Machine Model	Charged Device Model
Digital Inputs	4000V	250V	4kV
Digital Outputs	4000V	250V	4kV
Digital Bidirectional	4000V	250V	4kV
Digital Open Drain	4000V	250V	4kV
Analog Inputs	2000V	200V	4kV
Analog Outputs	1500V	100V	4kV
Reference Voltages	1500V	100V	4kV

The AN220E04 is an ESD (electrostatic discharge) sensitive device. Electrostatic charges as high as 4000V readily accumulate on the human body and test equipment and can discharge without detection. Although the AN220E04 device features proprietary ESD protection circuitry, permanent damage may occur on devices subjected to high-energy electrostatic discharges. Therefore, proper ESD precautions are recommended to avoid performance degradation or loss of functionality.

## Power Consumption – Low Power Mode

Parameter	Symbol	Min	Typ	Max	Unit	Comment
Minimum Power <sup>1a</sup>	I <sub>dd</sub>	-	0.2	-	mA	V <sub>dd</sub> =5.00 volts, T <sub>j</sub> =25°C
Nominal 25% Power <sup>1b</sup>	I <sub>dd</sub>	-	25	30	mA	V <sub>dd</sub> =5.00 volts, T <sub>j</sub> =25°C
Nominal 50% Power <sup>1c</sup>	I <sub>dd</sub>	-	42	47	mA	V <sub>dd</sub> =5.00 volts, T <sub>j</sub> =25°C
Nominal 75% Power <sup>1d</sup>	I <sub>dd</sub>	-	50	55	mA	V <sub>dd</sub> =5.00 volts, T <sub>j</sub> =25°C
Maximum Power <sup>1e</sup>	I <sub>dd</sub>	-	60	-	mA	V <sub>dd</sub> =4.75 volts, T <sub>j</sub> =85°C
			63	68		V <sub>dd</sub> =5.00 volts, T <sub>j</sub> =25°C
			66	-		V <sub>dd</sub> =5.25 volts, T <sub>j</sub> =-40°C
Temperature Coefficient	-	-	-2	-10	µA/°C	

- 1a. External clock, all analog function disabled, memory active.
- 1b. FPAA active elements – Two core op-amps (low power mode), one comparator, one input (bypass mode), one output filter and differential to single-ended converter (low power mode).
- 1c. FPAA active elements – Four core op-amps (low power mode), two comparators (one using SAR), two inputs (bypass mode), two output filters and two differential to single-ended converters (low power mode).
- 1d. FPAA active elements – Six core op-amps (low power mode), three comparators (two using SAR), three inputs (bypass mode), two output filters and two differential to single-ended converters (low power mode).
- 1e. FPAA active elements – Eight core op-amps (low power mode), four comparators (two using SAR), four inputs (bypass mode), two output filters and two differential to single-ended converters (low power mode).

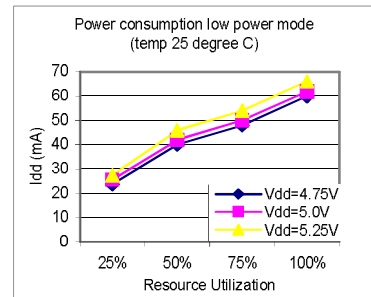

## Power Consumption – Full Power Mode

Parameter	Symbol	Min	Typ	Max	Unit	Comment
Full Power Mode Minimum Power <sup>2a</sup>	I <sub>dd</sub>	-	1.5	-	mA	V <sub>dd</sub> =5.00 volts, T <sub>j</sub> =25°C
Full Power Mode Nominal 25% Power <sup>2b</sup>	I <sub>dd</sub>	-	80	90	mA	V <sub>dd</sub> =5.00 volts, T <sub>j</sub> =25°C
Full Power Mode Nominal 50% Power <sup>2c</sup>	I <sub>dd</sub>	-	150	160	mA	V <sub>dd</sub> =5.00 volts, T <sub>j</sub> =25°C
Full Power Mode Nominal 75% Power <sup>2d</sup>	I <sub>dd</sub>	-	170	190	mA	V <sub>dd</sub> =5.00 volts, T <sub>j</sub> =25°C
Full Power Mode Maximum Power <sup>2e</sup>	I <sub>dd</sub>	-	200	-	mA	V <sub>dd</sub> =4.75 volts, T <sub>j</sub> =85°C
			210	230		V <sub>dd</sub> =5.00 volts, T <sub>j</sub> =25°C
			220	-		V <sub>dd</sub> =5.25 volts, T <sub>j</sub> =-40°C

- 2a. AN220E04 Crystal Oscillator, all analog functions disabled, memory active.
- 2b. FPAA active elements – Two core op-amps, one comparator, one input filter and chopper amplifier, one output filter and differential to single-ended converter.
- 2c. FPAA active elements – Four core op-amps, two comparators (one using SAR), two input filters and two chopper amplifiers, two output filters and two differential to single-ended converters.
- 2d. FPAA active elements – Six core op-amps, three comparators (two using SAR), three input filters and three chopper amplifiers, two output filters and two differential to single-ended converters.
- 2e. FPAA active elements – Eight core op-amps, four comparators (two using SAR), four input filters and two chopper amplifiers, two output filters and two differential to single-ended converters.

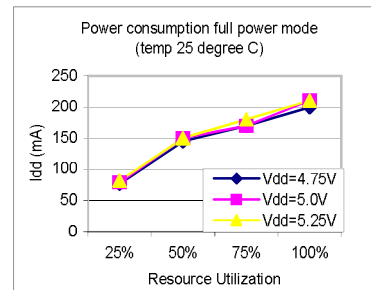

## AN220E04 Datasheet – Dynamically Reconfigurable FPAA

### PINOUT

Pin Number	Pin Name	Pin Type	Comments
1	I4PA	Analog IN+	
2	I4NA	Analog IN-	
3	O1P	Analog OUT+	
4	O1N	Analog OUT-	
5	AVSS	Analog Vss	
6	AVDD	Analog Vdd	
7	O2P	Analog OUT	
8	O2N	Analog OUT	
9	I1P	Analog IN+	
10	I1N	Analog IN-	
11	I2P	Analog IN+	
12	I2N	Analog IN-	
13	SHIELD	Analog Vdd	Low noise Vdd bias for capacitor array n-wells
14	AVDD2	Analog Vdd	Analog power
15	VREFMC	Vref	Attach filter capacitor for VREF-
16	VREFPC	Vref	Attach filter capacitor for VREF+
17	VMRC	Vref	Attach filter capacitor for VMR (Voltage Main Reference)
18	BVDD	Analog Vdd	Analog power for bandgap Vref Generators
19	BVSS	Analog Vss	Analog ground for bandgap Vref Generators
20	CFGFLGb	Digital IN	In multi-device systems... 0, Ignore incoming data (unless currently addressed) 1, Pay attention to incoming data (watching for address)
		Digital OUT	0, Device is being configured Z, Device is not being configured (if internal pullup is selected)
21	CS2b	Digital IN	0, Chip is selected 1, Chip is not selected
22	CS1b	Digital IN (during config)	0, Allow configuration to proceed 1, Hold off configuration
		Digital IN (after config)	Passes read-back data through to LCC_B pin
23	DCLK	Digital IN	
24	SVSS	Digital Vss	Digital ground - substrate tie
25	MODE	Digital IN	0, Synchronous serial interface 1, SPI EPROM Interface
26	ACLK / SPIP	Digital IN	MODE = 0, analog clock < 40 MHz
		Digital OUT	MODE = 1, SPI EPROM or serial EPROM clock
27	OUTCLK / SPIMEM	Digital OUT	During power-up, sources SPI EPROM initialization command string
		Digital OUT	After power-up, sources any of the four internal analog clocks
28	DVDD	Digital Vdd	
29	DVSS	Digital Vss	
30	DIN	Digital IN	Serial configuration data input
31	LCCb	Digital OUT	1, Local configuration is needed. Once configuration is completed, it is a registered version of CS1b or if the device is addressed for read, it serves as serial data out port
32	ERRb	Digital IN (monitored OUT)	0, Initiate reset 1, No action
		Digital OUT	0, Error condition Z, No error condition (external pullup required)
33	ACTIVATE	Digital IN	0, Hold off completion of configuration Rising Edge, Allow completion of configuration O.D. Output 0, device has not yet completed primary configuration Z, Device has completed primary configuration (if internal pullup is selected)
34	DOUTCLK / TEST	Digital OUT	A buffered version of DCLK.
		Digital IN	(Factory reserved test input. Float if unused)
35	PORb	Digital IN	0, Chip held in reset state Rising edge, re-initiates power on reset sequence To initiate a POR reset cycle, the minimum pulse width required on the PORb pin is 25ns.
36	EXECUTE	Digital IN	0, No action 1, Transfer shadow RAM into configuration RAM
37	I3P	Analog IN+	
38	I3N	Analog IN-	
39	I4PD	Analog IN+	Analog multiplexer input signals. The multiplexer can accept 4 differential inputs or 8 single ended inputs
40	I4ND	Analog IN-	
41	I4PC	Analog IN+	
42	I4NC	Analog IN-	
43	I4PB	Analog IN+	
44	I4NB	Analog IN-	



# AN220E04 Datasheet – Dynamically Reconfigurable FPAA

## MECHANICAL AND HANDLING

The AN220E04 comes in the industry standard 44 lead QFP package.

Dry pack handling is recommended. The package is qualified to MSL3 (JEDEC Standard, J-STD-020A, Level 3). Once the device is removed from dry pack, 30°C at 60% humidity for not longer than 168 hours is the maximum recommended exposure prior to solder reflow. If out of dry pack for longer than this recommended period of time, then the recommended bake out procedure prior to solder reflow is 24 hours at 125°C.

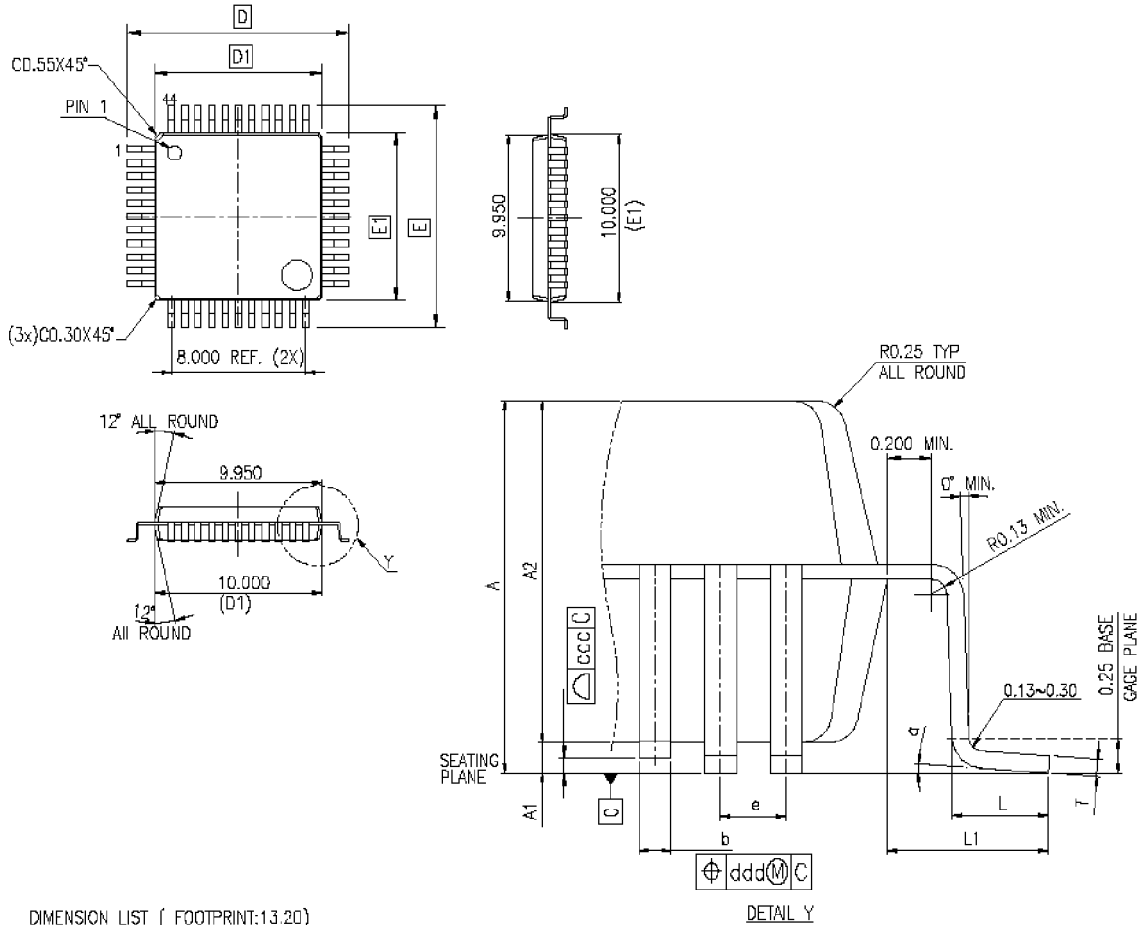

DIMENSION LIST ( FOOTPRINT:13.20)

S/N	SYM	DIMENSIONS	REMARKS
1	A	MAX. 2.450	OVERALL HEIGHT
2	A1	MAX. 0.500	STANDOFF
3	A2	2.000±0.200	PKG THICKNESS
4	D	13.200±0.250	LEAD TIP TO TIP
5	D1	10.000±0.100	PKG LENGTH
6	E	13.200±0.250	LEAD TIP TO TIP
7	E1	10.000±0.100	PKG WIDTH
8	L	0.880±0.150	FOOT LENGTH
9	L1	1.600 REF.	LEAD LENGTH
10	T	0.130~0.230	FRAME THICKNESS
11	a	0~7°	LEAD FLAT ANGLE
12	b	0.300~0.450	LEAD WIDTH
13	e	0.800 BASE	LEAD PITCH
14	ccc	0.100	FOOT PLANARITY
15	ddd	0.100	FOOT POSITION

NOTES :

S/N	DESCRIPTION	SPECIFICATION
1	GENERAL TOLERANCE, DISTANCE	±0.100
	ANGLE	±2.5°
2	MATTE FINISH ON PACKAGE BODY SURFACE EXPECT EJECTION AND PIN 1 MARKING.	Ra1.5~2.5um
3	ALL MOLDED BODY SHARP CORNER RADII UNLESS OTHERWISE SPECIFIED.	MAX. R0.200
4	PACKAGE/LEADFRAME MISALIGNMENT ( X, Y ):	MAX. 0.127
5	TOP/BTM PACKAGE MISALIGNMENT ( X, Y ):	MAX. 0.127
6	DRAWING DOES NOT INCLUDE PLASTIC OR METAL PROTRUSION OR CUTTING BURR.	
7	COMPLIANT TO JEDEC STANDARD: MS-022	

# AN220E04 Datasheet – Dynamically Reconfigurable FPAA

## Distortion, SINAD and SNR Measurements

The following plots give an indication of the Distortion, SINAD and SNR for some representative CAMs.

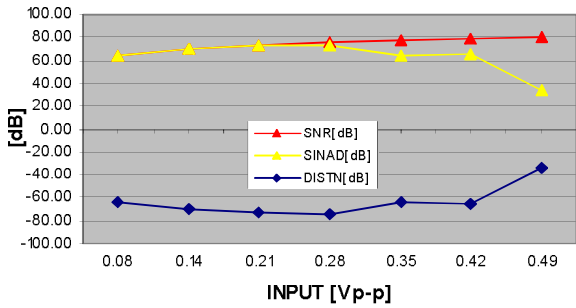
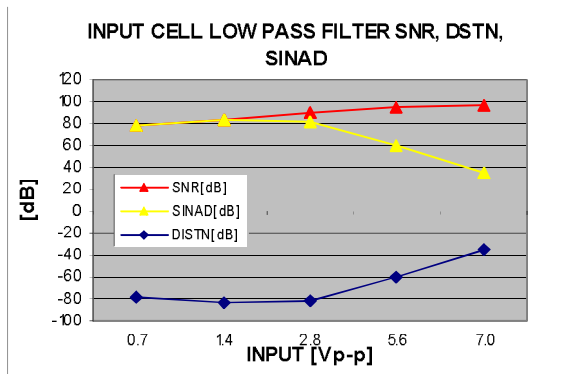
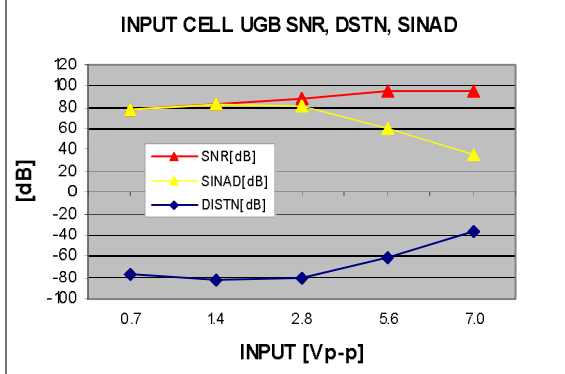

**INPUT CELL AMPLIFIER SNR, DSTN, SINAD**  
 Measured with Inputcell Gain G = 16  
 Same results for Input Amplifier and Chopper Amplifier stage, If the signal from the chopper Amplifier is correctly filtered before measurement.

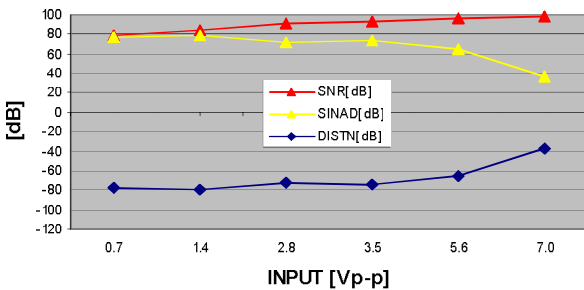
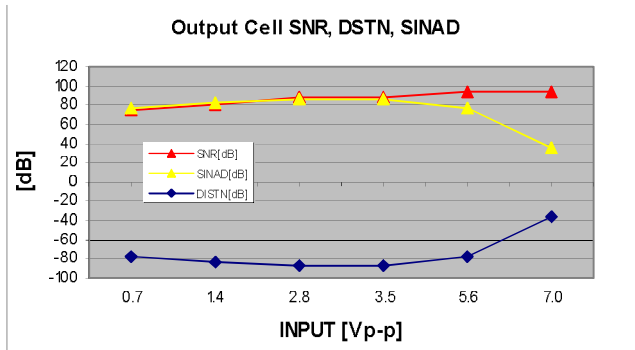

**GAININV CAM SNR, DSTN, SINAD**  
 This graph shows the typical performance of an FPAA CAB when configured with a CAM in this example GainInv CAM  
 Input signal=1400 mV p-p differential,  
 CAM clock = 1MHz CAM parameter settings Gain = 1

# AN220E04 Datasheet – Dynamically Reconfigurable FPAA

## Power Supply Rejection Ratio (PSRR) Measurements

The following plots give an indication of the PSRR for some representative CAMs.  
 AVDD to Power Supply (PS): 5v +/- 0.25v sinusoidal waveform (100 kHz to 1 MHz)

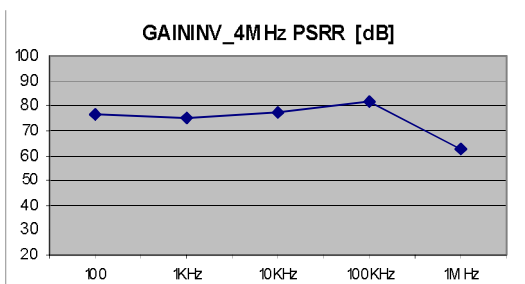
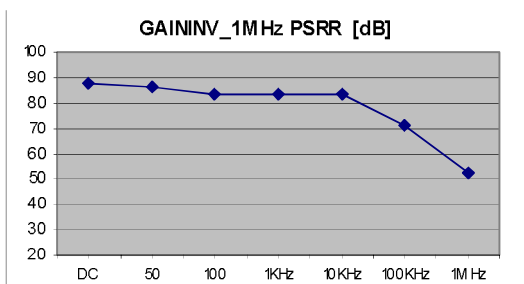
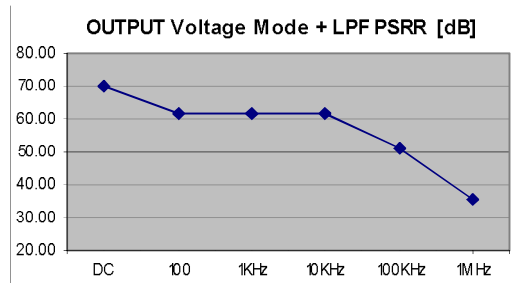
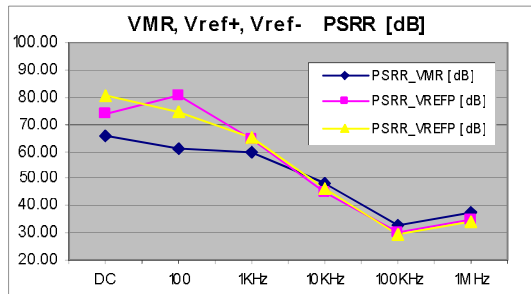
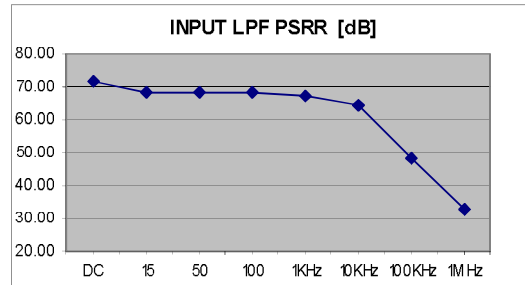
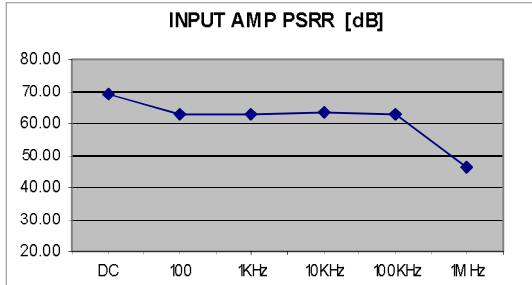

## AN220E04 Datasheet – Dynamically Reconfigurable FPAA

The following is provided for information only, as and when additional characterization data is collected 'noise measurements' will be added formally to the datasheet.

### Noise And Distortion Observations

The following plots give an indication of the noise characteristics of Anadigm<sup>®</sup>'s AN220E04 FPAA device. These were done using a simple set-up and in many cases reflect the noise limit of the setup. Actual device noise margins are expected to be better.

*Signal and Noise for the Input Cell (input signal - 50mVp-p differential to the FPAA at 10 kHz)*

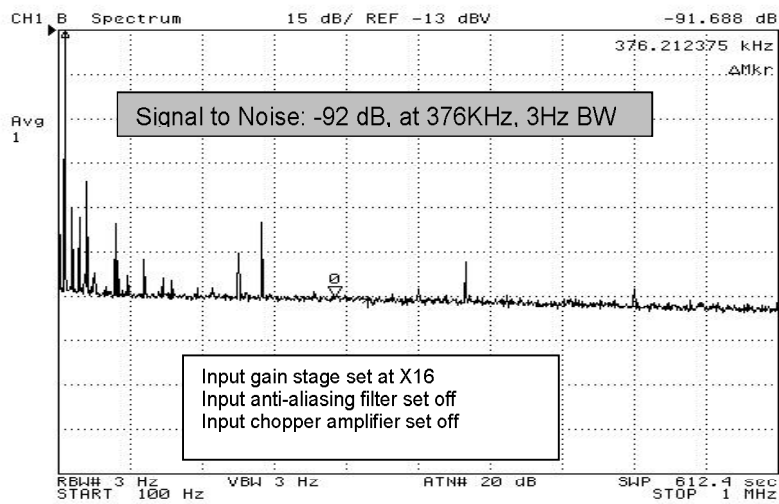

*Signal and Noise for the Output Cell (with a differential input 4V p-p, 660Hz)*

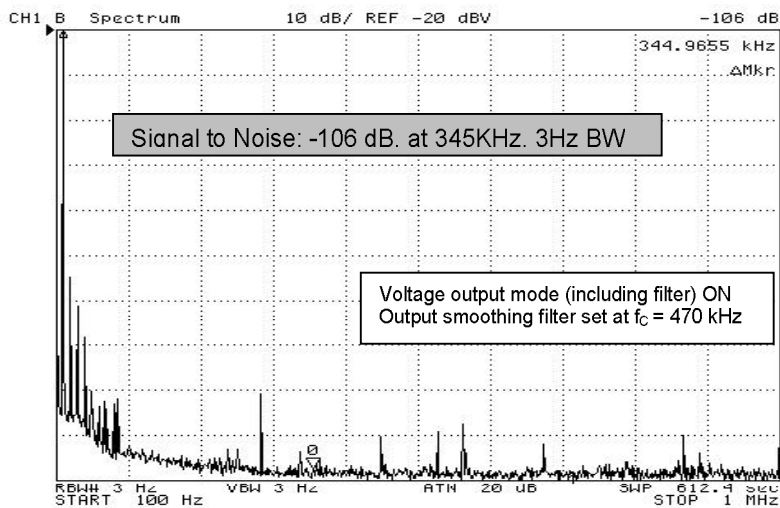

## AN220E04 Datasheet – Dynamically Reconfigurable FPAA

Measured THD for input and output cells (with a differential input 4V p-p, 660Hz)

Settings	Distortion in dB
Input cell with anti-aliasing filter set at $f_c = 470$ kHz	81.6
Output cell with differential to single ended converter and output smoothing filter set at $f_c = 470$ kHz	82

Signal and Noise for a representative CAM – Gaininv CAM (input signal of 700mV p-p differential at 10 kHz)

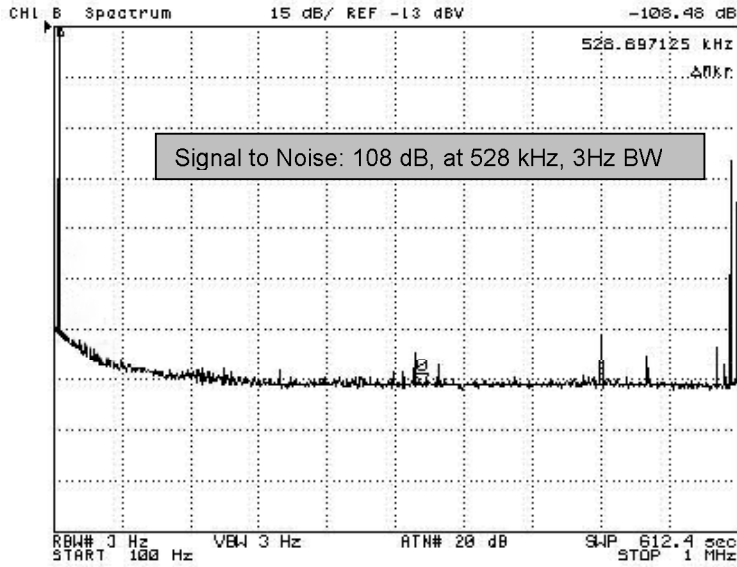

THD for a representative CAM – Gaininv CAM (with a differential input 4V p-p, 660Hz)

CAM Clock Frequency	Distortion (dB)
250 KHz	80.00
1 MHz	72.83
2 MHz	69.22
4 MHz	73.48

