

Agilent AMMP-6530

5–30 GHz Image Reject Mixer

Data Sheet

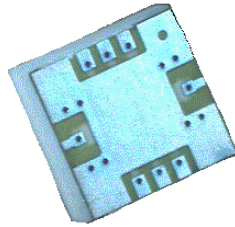
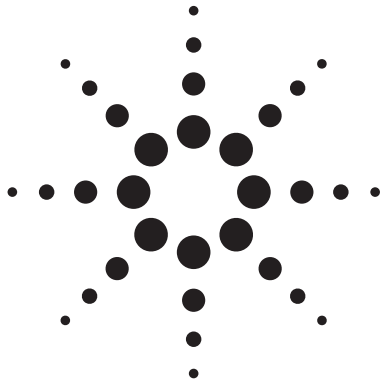

Description

Agilent's AMMP-6530 is an image reject mixer that operates from 5 GHz to 30 GHz. The cold channel FET mixer is designed to be an easy-to-use component for any surface mount PCB application. It can be used drain pumped for low conversion loss applications, or when gate pumped the mixer can provide high linearity for SSB up-conversion. An external 90-degree hybrid is used to achieve image rejection and a -1V voltage reference is needed. Intended applications include microwave radios, 802.16, VSAT, and satellite receivers. Since this one mixer can cover several bands, the AMMP-6530 can reduce part inventory. The integrated mixer eliminates complex tuning and assembly processes typically required by hybrid (discrete-FET or diode) mixers. The package is fully SMT compatible with backside grounding and I/O to simplify assembly.

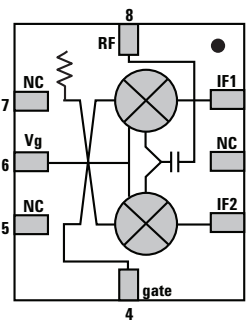

Top view
package base: GND

Pin	Function
1	IF1
2	
3	IF2
4	LO
5	
6	Vg
7	
8	RF

Features

- 5x5 mm Surface Mount Package
- Broad Band Performance 5–30 GHz
- Low Conversion Loss of 8 dB
- High Image Rejection of 15–20 dB
- Good 3rd Order Intercept of +18 dBm
- Single -1V, no current Supply Bias

Applications

- Microwave Radio Systems
- Satellite VSAT, DBS Up/Down Link
- LMDS & Pt-Pt mmW Long Haul
- Broadband Wireless Access (including 802.16 and 802.20 WiMax)
- WLL and MMDS loops
- Commercial grade military

Absolute Maximum Ratings^[1]

Symbol	Parameters/Conditions	Units	Min.	Max.
V _g	Gate Supply Voltage	V	0	-3
P _{in}	CW Input Power	dBm		15
T _{ch}	Operating Channel Temperature	°C		+150
T _{stg}	Storage Case Temperature	°C	-65	+150
T _{max}	Max. Assembly Temp (60 sec max)	°C		+300

Note:

1. Operation in excess of any one of these conditions may result in permanent damage to this device.



Attention: Observe precautions for handling electrostatic sensitive devices.

ESD Machine Model (Class A)

ESD Human Body Model (Class 0)

Refer to Agilent Application Note A004R: *Electrostatic Discharge Damage and Control.*



Agilent Technologies

AMMP-6530 DC Specifications/Physical Properties^[1]

Symbol	Parameters and Test Conditions	Units	Typ.
I_g	Gate Supply Current (under any RF power drive and temperature)	mA	0
V_g	Gate Supply Operating Voltage	V	-1V

Note:

1. Ambient operational temperature $T_A=25^\circ\text{C}$ unless otherwise noted.

AMMP-6530 Typical Performance^[2, 3] ($T_A = 25^\circ\text{C}$, $V_g = -1\text{V}$, IF frequency = 1 GHz, $Z_o = 50\ \Omega$)

Symbol	Parameters and Test Conditions	Units	Gate Pumped		Drain Pumped
			Down Conversion	Up Conversion	Down Conversion
F_{RF}	RF Frequency Range	GHz	5 – 30		5 – 30
F_{LO}	LO Frequency Range	GHz	5 – 30		5 – 30
F_{IF}	IF Frequency Range	GHz	DC – 5		DC – 5
			Down Conversion	Up Conversion	Down Conversion
P_{LO}	LO Port Pumping Power	dBm	>10	>0	>10
CG	RF to IF Conversion Gain	dB	-10	-15	-8
RL_RF	RF Port Return Loss	dB	5	5	10
RL_LO	LO Port Return Loss	dB	10	10	5
RL_IF	IF Port Return Loss	dB	10	10	10
IR	Image Rejection Ratio	dB	15	15	15
LO-RF Iso.	LO to RF Port Isolation	dB	22	25	22
LO-IF Iso.	LO to IF Port Isolation	dB	25	25	25
RF-IF Iso.	RF to IF Port Isolation	dB	15	15	15
IIP3	Input IP3, $F_{\Delta}=100\ \text{MHz}$, $P_{rf} = -10\ \text{dBm}$, $P_{lo} = 15\ \text{dBm}$	dBm	18	—	10
P-1	Input Port Power at 1dB gain compression point, $P_{lo}=+10\ \text{dBm}$	dBm	8	—	0
NF	Noise Figure	dB	10	—	12

Notes:

- Small/Large signal data measured in a fully de-embedded test fixture form $T_A = 25^\circ\text{C}$.
- Specifications are derived from measurements in a $50\ \Omega$ test environment.

AMMP-6530 RF Specifications in Drain Pumped Test Configuration^[4, 5, 6, 7]

($T_A = 25^\circ\text{C}$, $V_g = -1.0\text{V}$, $P_{LO} = +10\ \text{dBm}$, $Z_o = 50\ \Omega$)

Symbol	Parameters and Test Conditions	Units	Typ.	Sigma
CG	Conversion Gain	dB	-8	0.5
IR	Image Rejection Ratio	dB	20	1.0

Notes:

- Pre-assembly into package performance verified 100% on-wafer.
- 100% on-wafer RF testing is done at RF frequency = 7, 18, and 28 GHz; IF frequency = 2 GHz.
- This final package part performance is verified by a functional test correlated to actual performance.
- The external 90 degree hybrid coupler is from M/A-COM: PN 2032-6344-00. Frequency 1.0– 2.0 GHz.

AMMP-6530 Typical Performance under Gate Pumped Down Conversion Operation

($T_A = 25^\circ\text{C}$, $V_g = -1\text{V}$, $Z_o = 50\Omega$)

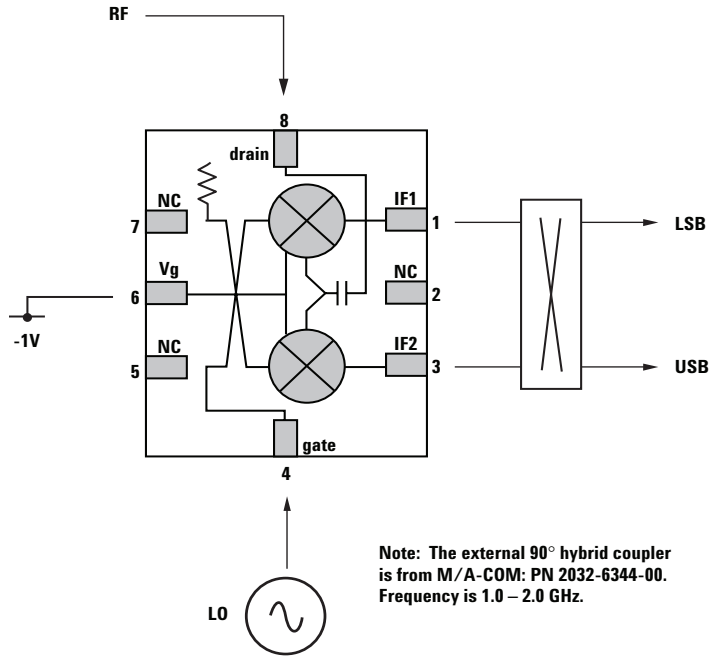

Note: The external 90° hybrid coupler is from M/A-COM: PN 2032-6344-00. Frequency is 1.0 – 2.0 GHz.

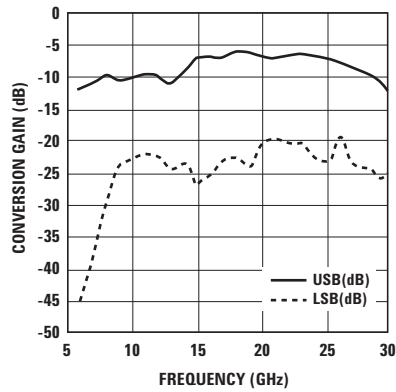

Figure 1. Conversion Gain with IF terminated for Low Side Conversion
LO=+10 dBm, IF=1 GHz.

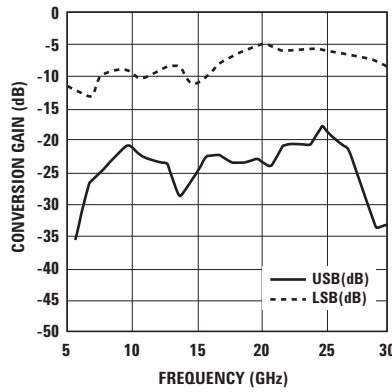

Figure 2. Conversion Gain with IF terminated for High Side Conversion
LO=+10 dBm, IF=1 GHz.

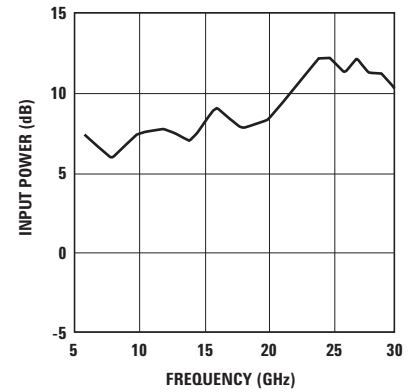

Figure 3. RF Port Input Power P-1dB.
LO=+10 dBm, IF=1 GHz.

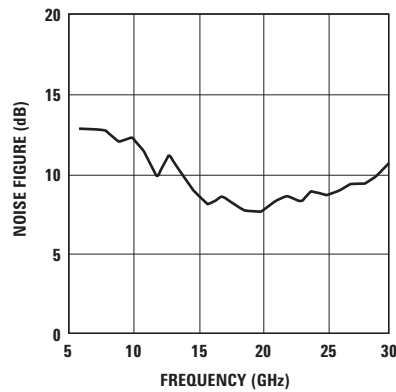

Figure 4. Noise Figure.
LO=+7 dBm, IF=1 GHz.

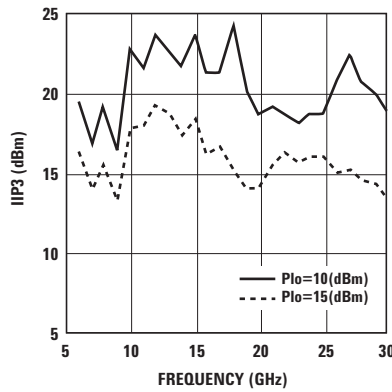

Figure 5. Input 3rd Order Intercept Point.
IF=1 GHz.

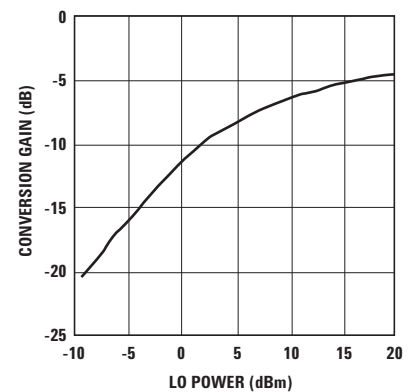

Figure 6. Conversion Gain vs. LO Power.
RF=21 GHz (-20 dBm), LO=20 GHz.

AMMP-6530 Typical Performance under Gate Pumped Down Conversion Operation ($T_A = 25^\circ\text{C}$, $V_g = -1\text{V}$, $Z_o = 50\Omega$)

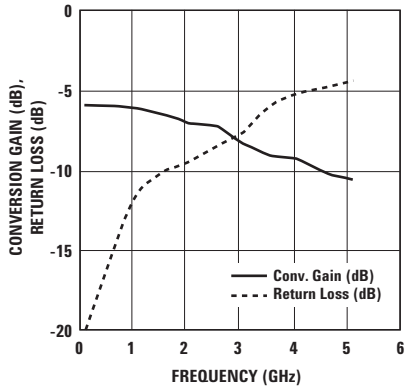

Figure 7. Conversion Gain and Match vs. IF Frequency. RF=20 GHz, LO=10 dBm.

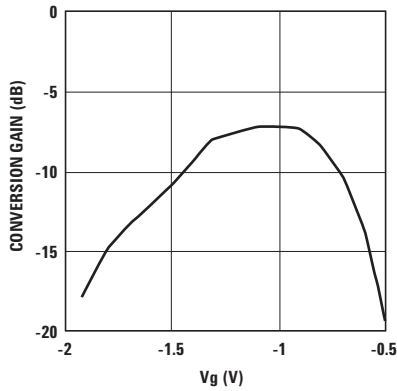

Figure 8. Conversion Gain vs. Gate Voltage. RF=20 GHz, LO=10 dBm.

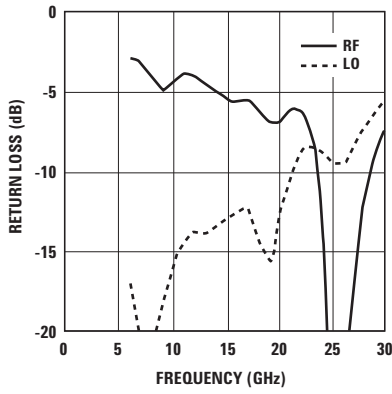

Figure 9. RF & LO Return Loss. LO=10 dBm.

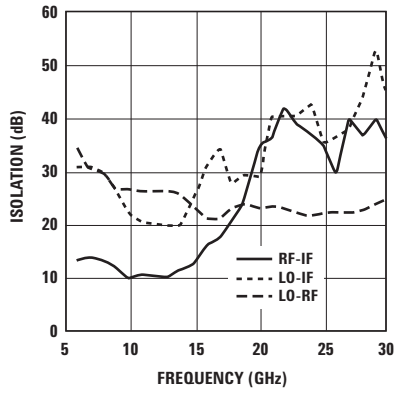

Figure 10. Isolation. LO=+10 dBm, IF=1 GHz.

AMMP-6530 Typical Performance under Gate Pumped Up Conversion Operation ($T_A = 25^\circ\text{C}$, $V_g = -1\text{V}$, $Z_o = 50\Omega$)

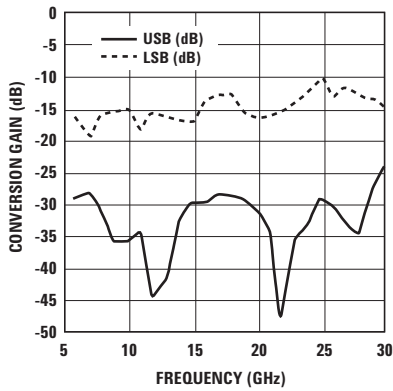
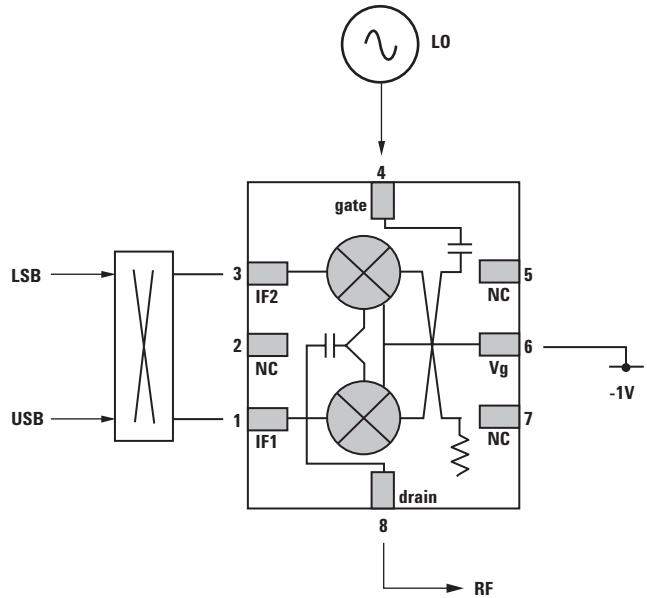

Figure 11. Up-conversion Gain with IF terminated for Low Side Conversion.
 LO=+5 dBm, IF=+5 dBm, IF=1 GHz.

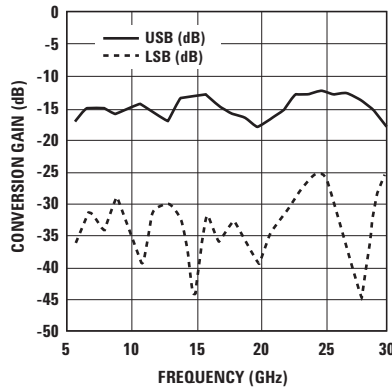

Figure 12. Up-conversion Gain with IF terminated for High Side Conversion.
 LO=+5 dBm, IF=+5 dBm, IF=1 GHz.

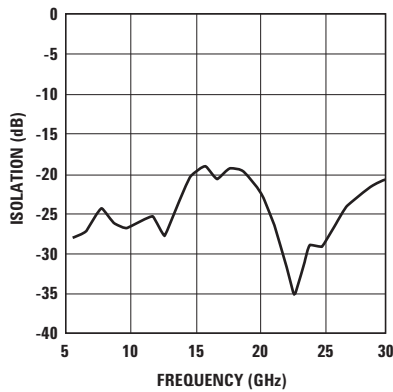

Figure 13. LO-RF Up-conversion Isolation.

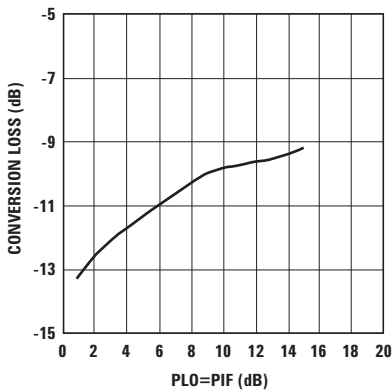

Figure 14. Up-conversion Gain vs. Pumping Power. LO power=IF power, IF=1 GHz, RF=25 GHz.

AMMP-6530 Typical Performance under Drain Pumped Down Conversion Operation

($T_A = 25^\circ\text{C}$, $V_g = -1\text{V}$, $Z_o = 50\Omega$)

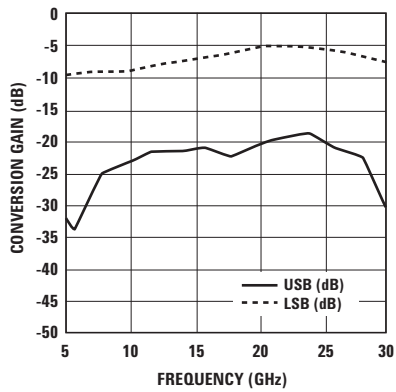
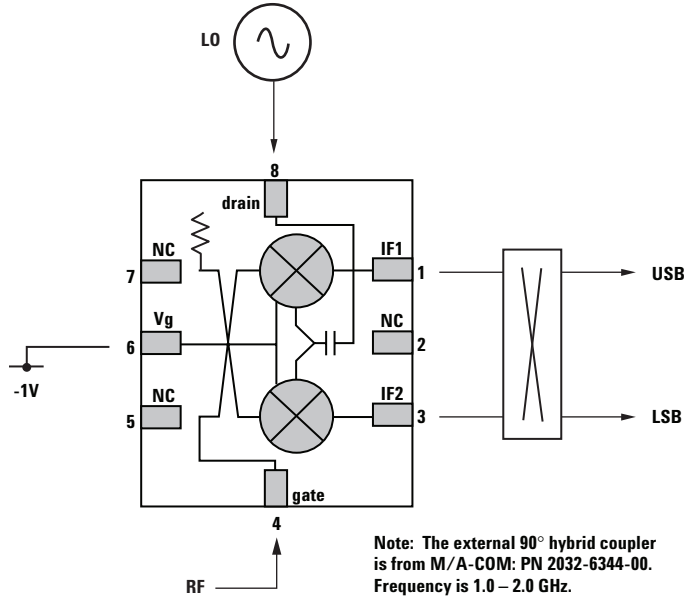

Figure 15. Conversion Gain with IF terminated for Low Side Conversion. LO=+10 dBm, IF=1 GHz.

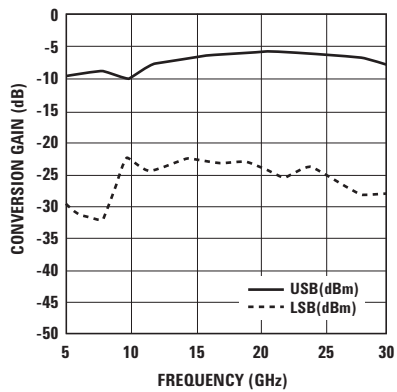

Figure 16. Conversion Gain with IF terminated for High Side Conversion. LO=+10 dBm, IF=1 GHz.

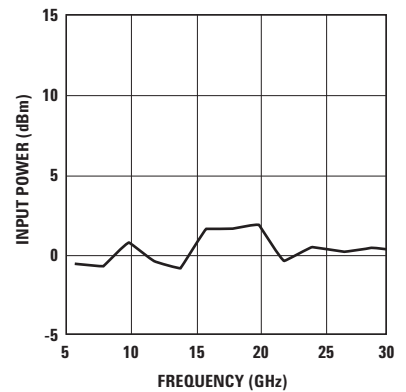

Figure 17. RF Port Input Power P-1dB. LO=+10 dBm, IF=1 GHz.

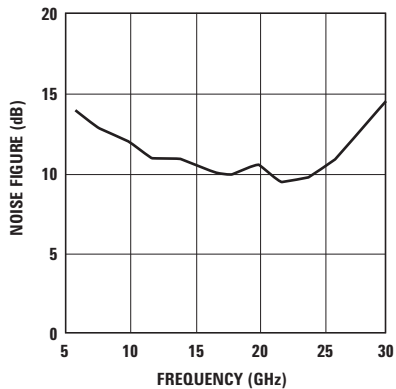

Figure 18. Noise Figure. LO=+7 dBm, IF=1 GHz.

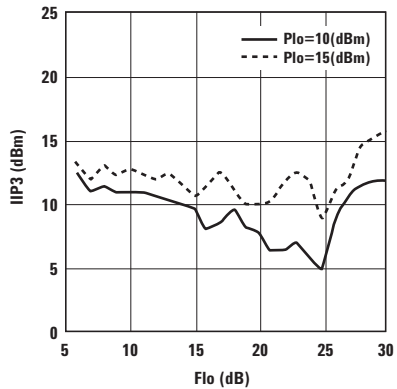

Figure 19. Input 3rd Order Intercept Point. IF=1 GHz.

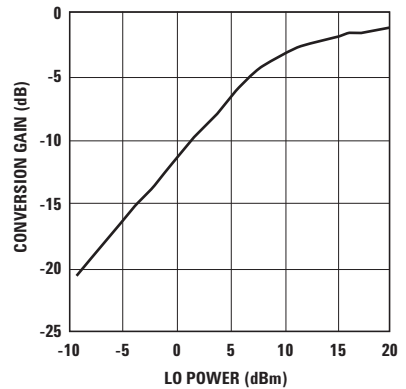

Figure 20. Conversion Gain vs. LO power. RF=21 GHz (-20 dBm), LO=20 GHz.

Biassing and Operation

The recommended DC bias condition for optimum performance, and reliability is $V_g = -1$ volts. There is no current consumption for the gate biasing because the FET mixer was designed for passive operation. For down conversion, the AMMP-6530 may be configured in a low loss or high linearity application. In a low loss configuration, the LO is applied through the drain (Pin8, power divider side). In this configuration, the AMMP-6530 is a “drain pumped mixer”. For higher linearity applications, the LO is applied through the gate (Pin4, Lange coupler side). In this configuration, the AMMP-6530 is a “gate pumped mixer” (or Resistive mixer). The mixer is also suitable for up-conversion applications under the gate pumped mixer operation shown on page 3.

Please note that the image rejection and isolation performance is dependent on the selection of the low frequency quadrature hybrid. The performance specification of the low frequency quadrature hybrid as well as the phase balance and VSWR of the interface to the AMMP-6530 will affect the overall mixer performance.

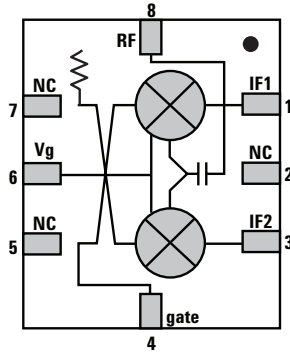

Figure 21. Simplified MMIC Schematic.

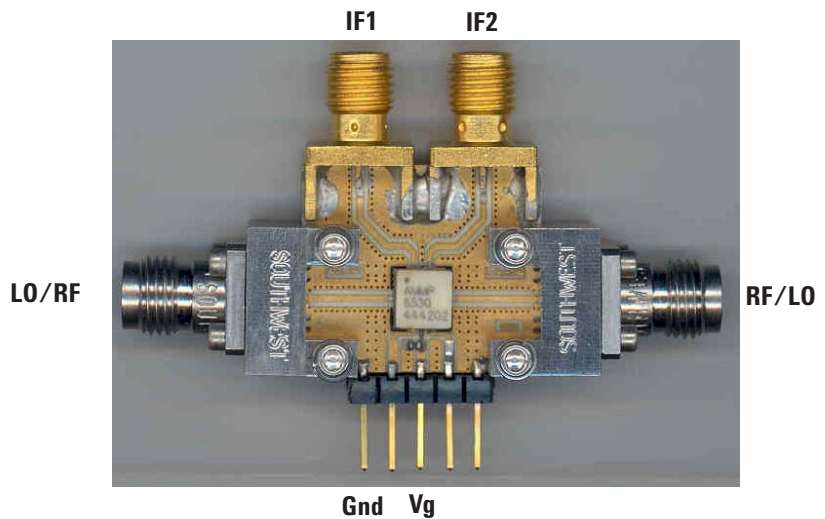
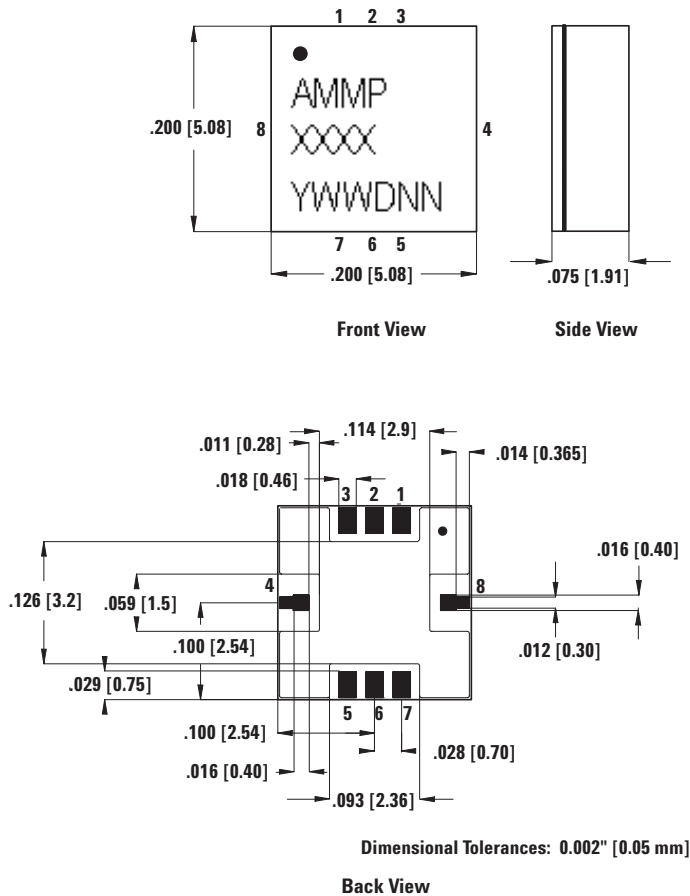

Figure 22. Demonstration Board (available upon request).



- Notes:
1. * Indicates Pin 1
 2. Dimensions are in inches [millimeters]
 3. All Grounds must be soldered to PCB RF Ground

Figure 23. Outline Drawing.

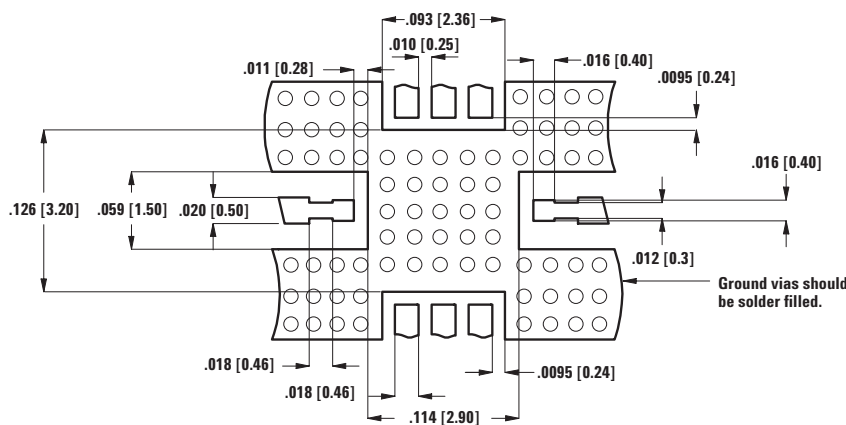

Figure 24. Suggested PCB Material and Land Pattern. Dimensions in inches [mm]. Material is Rogers R04350, 0.010" thick.

Recommended SMT Attachment

The AMMP Packaged Devices are compatible with high volume surface mount PCB assembly processes.

The PCB material and mounting pattern, as defined in the data sheet, optimizes RF performance and is strongly recommended. An electronic drawing of the land pattern is available upon request from Agilent Sales & Application Engineering.

Manual Assembly

1. Follow ESD precautions while handling packages.
2. Handling should be along the edges with tweezers.
3. Recommended attachment is conductive solder paste. Please see recommended solder reflow profile. Conductive epoxy is *not* recommended. Hand soldering is *not* recommended.
4. Apply solder paste using a stencil printer or dot placement. The volume of solder paste will be dependent on PCB and component layout and should be controlled to ensure consistent mechanical and electrical performance.
5. Follow solder paste and vendor's recommendations when developing a solder reflow profile. A standard profile will have a steady ramp up from room temperature to the pre-heat temperature to avoid damage due to thermal shock.
6. Packages have been qualified to withstand a peak temperature of 260°C for 20 seconds. Verify that the profile will not expose device beyond these limits.

Solder Reflow Profile

The most commonly used solder reflow method is accomplished in a belt furnace using convection heat transfer. The suggested reflow profile for automated reflow processes is shown in Figure 25. This profile is designed to ensure reliable finished joints. However, the profile indicated in Figure 25 will vary among different solder pastes from different manufacturers and is shown here for reference only.

Stencil Design Guidelines

A properly designed solder screen or stencil is required to ensure optimum amount of solder paste is deposited onto the PCB pads. The recommended stencil layout is shown in Figure 26. The stencil has a solder paste deposition opening approximately 70% to 90% of the PCB pad. Reducing stencil opening can potentially generate more voids underneath. On the other hand, stencil openings larger

than 100% will lead to excessive solder paste smear or bridging across the I/O pads. Considering the fact that solder paste thickness will directly affect the quality of the solder joint, a good choice is to use a laser cut stencil composed of 0.127 mm (5 mils) thick stainless steel which is capable of producing the required fine stencil outline. The combined PCB and stencil layout is shown in Figure 27.

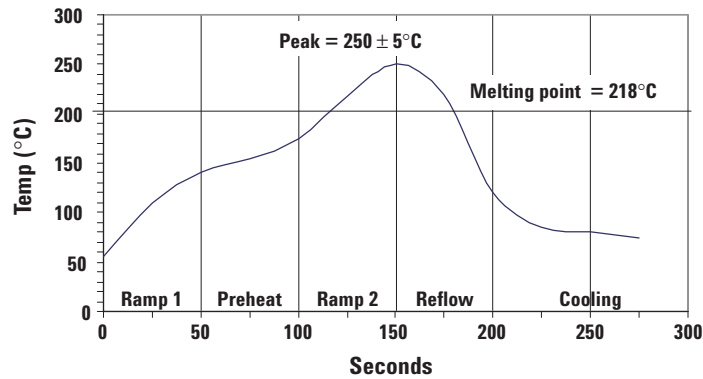

Figure 25. Suggested Lead-Free Reflow Profile for SnAgCu Solder Paste.

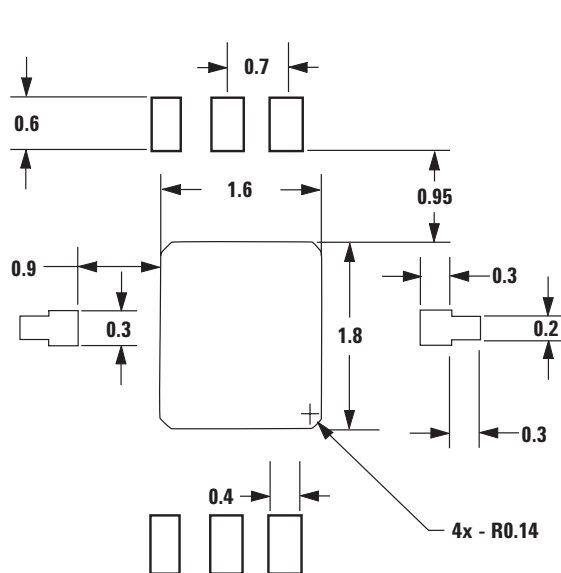

Figure 26. Stencil Outline Drawing (mm).

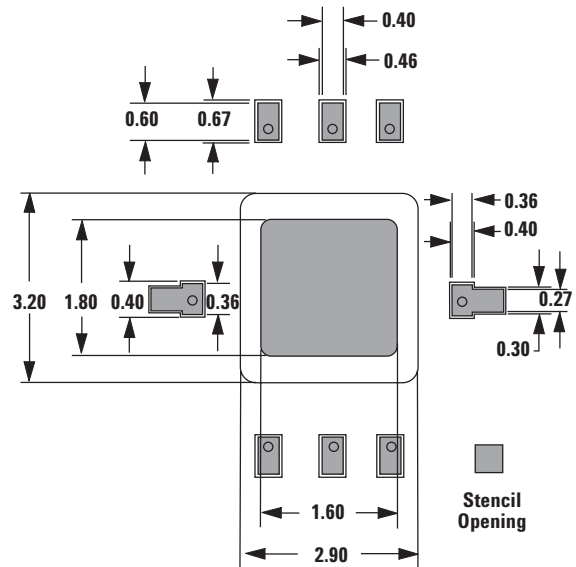
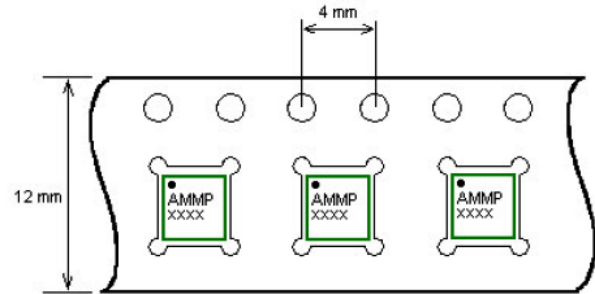

Figure 27. Combined PCB and Stencil Layouts (mm).

Part Number Ordering Information

Part Number	Devices per Container	Container
AMMP-6530-BLK	10	antistatic bag
AMMP-6530-TR1	100	7" Reel
AMMP-6530-TR2	500	7" Reel

Device Orientation (Top View)



Carrier Tape and Pocket Dimensions

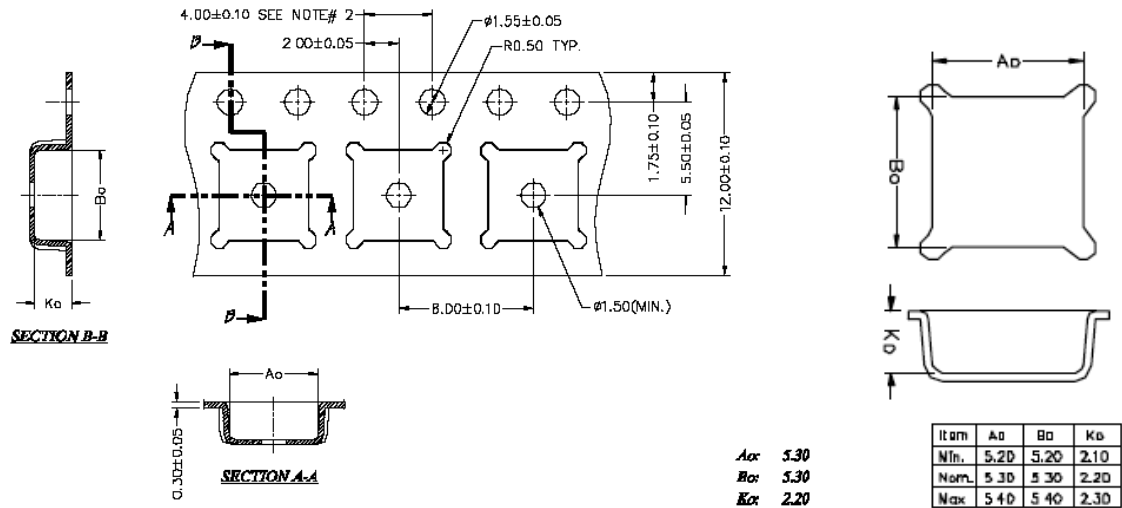

- NOTES:
1. Ao & Bo measured at 0.3mm above base of pocket.
 2. 10 pitches cumulative tol. ±0.2mm

Ao: 5.30
Bo: 5.30
Ko: 2.20
Pitch: 8.00
Width: 12.00

www.agilent.com/semiconductors

For product information and a complete list of distributors, please go to our web site.

For technical assistance call:

Americas/Canada: +1 (800) 235-0312 or (916) 788-6763

Europe: +49 (0) 6441 92460

China: 10800 650 0017

Hong Kong: (65) 6756 2394

India, Australia, New Zealand: (65) 6755 1939

Japan: (+81 3) 3335-8152(Domestic/International), or 0120-61-1280(Domestic Only)

Korea: (65) 6755 1989

Singapore, Malaysia, Vietnam, Thailand, Philippines, Indonesia: (65) 6755 2044

Taiwan: (65) 6755 1843

Data subject to change.

Copyright © 2005 Agilent Technologies, Inc.

February 24, 2005

5989-2352EN



Agilent Technologies