

● Features

1. Current transfer ratio

CTR: MIN.60 at $I_f = \pm 1\text{mA}$ $V_{ce} = 5\text{V}$

2. High isolation voltage between input and output (Viso: 5000Vrms).

3. Compact dual-in-line package.

4. AC input.

● Applications

1. Programmable Controller Applications for Low Input Photocouplers and High Vceo Photocouplers.

2. Telephone sets, telephone exchangers.

3. System appliances. ● Limit Switches ● Sensors ● Thermostats ● Transducers etc.

4. Signal transmission between circuits of different potentials and impedances.

1. OUTSIDE DIMENSION : UNIT (mm)

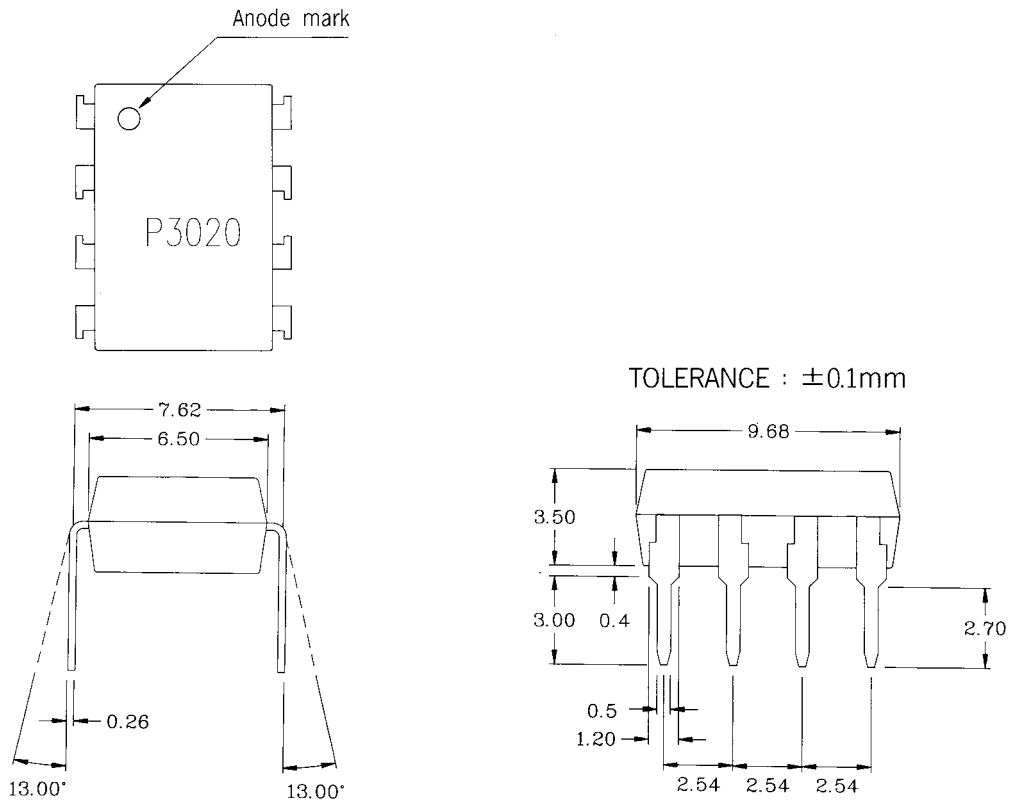

2. SCHEMATIC : TOP VIEW

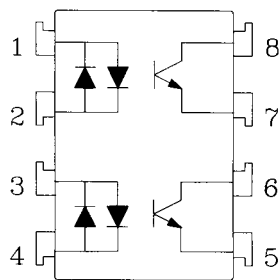

- 1,2. Anode, Cathode
- 3,4. Anode, Cathode
- 5,7. Emitter
- 6,8. Collector

● Absolute Maximum Ratings

(Ta=25°C)

	Parameter	Symbol	Rating	Unit
Input	Forward current	I_F	± 50	mA
	Peak forward current	I_{FM}	± 1	A
	Power dissipation	P_D	70	mW
Output	Collector-emitter voltage	V_{CE0}	60	V
	Emitter-collector voltage	V_{ECO}	6	V
	Collector current	I_C	50	mA
	Collector power dissipation	P_C	150	mW
	Total power dissipation	P_{tot}	200	mW
	Isolation voltage 1 minute	V_{iso}	5000	Vrms
	Operating temperature	T_{opr}	-30 to +100	°C
	Storage temperature	T_{stg}	-55 to +125	°C
	Soldering temperature 10 seconds	T_{sol}	260	°C

● Electro-optical Characteristics

(Ta=25°C)

	Parameter	Symbol	Conditions	MIN	TYP	MAX	Unit
Input	Forward voltage	V_F	$I_F = \pm 20\text{mA}$	-	1.2	1.4	V
	Peak forward voltage	V_{FM}	$I_{FM} = \pm 0.5\text{A}$	-	-	3.5	V
	Terminal capacitance	C_t	$V=0, f=1\text{kHz}$	-	30	-	pF
Output	Collector dark current	I_{CE0}	$V_{CE}=20\text{V}, I_F=0$	-	-	10^{-7}	A
Transfer characteristics	Current transfer ratio	CTR	$I_F = \pm 1\text{mA}, V_{CE}=5\text{V}$	60	-	600	%
	Collector-emitter saturation voltage	$V_{CE(sat)}$	$I_F = \pm 20\text{mA}, I_C=1\text{mA}$	-	0.1	0.3	V
	Isolation resistance	R_{iso}	DC500V	5×10^{10}	10^{11}	-	ohm
	Floating capacitance	C_f	$V=0, f=1\text{MHz}$	-	0.6	1.0	pF
	Cut-off frequency	f_c	$V_{CE}=5\text{V}, I_C=2\text{mA}, R_L=100\text{ohm}$	-	80	-	kHz
	Response time (Rise)	t_r	$V_{CE}=2\text{V}, I_C=2\text{mA}, R_L=100\text{ohm}$	-	5	20	μs
	Response time (Fall)	t_f		-	4	20	μs

Fig 1 Current Transfer Ratio vs. Forward Current

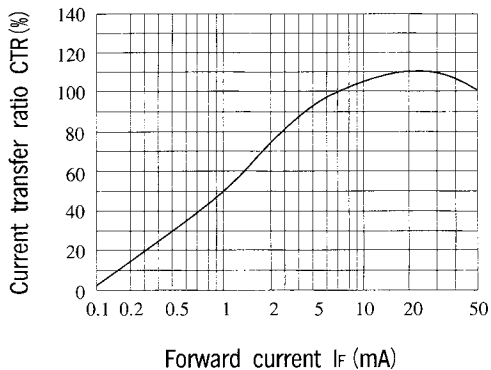

Classification table of current transfer ratio is shown below.

Model NO.	Rank mark	CTR (%)
P3020	A	60 TO 600
P3020	B	60 TO 300

Fig. 2 Collector Power Dissipation vs. Ambient Temperature

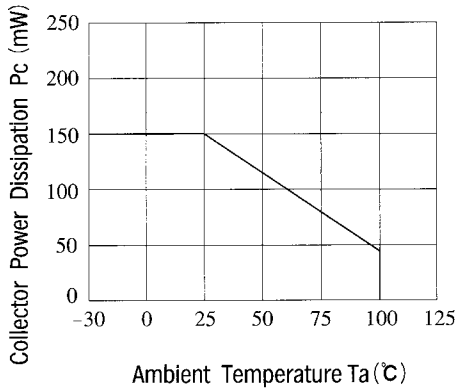

Fig. 3 Collector Dark Current vs. Ambient Temperature

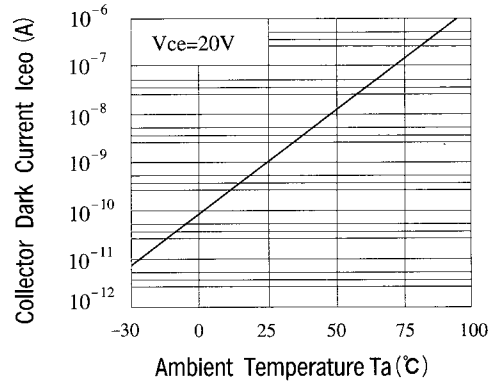

Fig. 4 Forward Current vs. Ambient Temperature

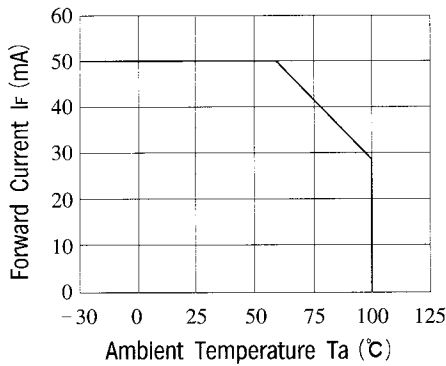

Fig. 5 Forward Current vs. Forward Voltage

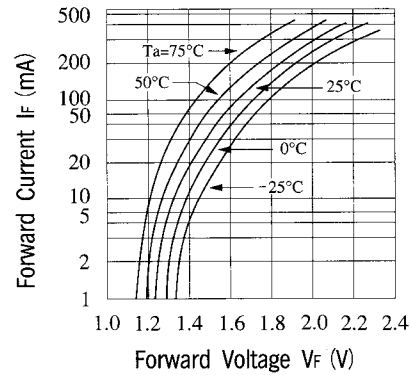

Fig. 6 Collector Current vs. Collector-emitter Voltage

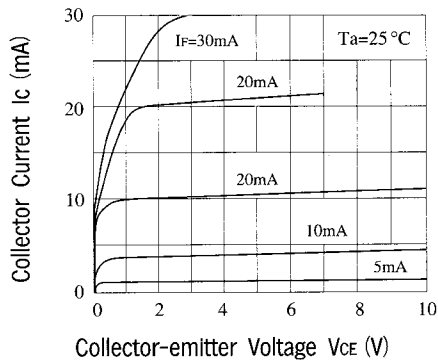

Fig. 7 Relative Current Transfer Ratio vs. Ambient Temperature

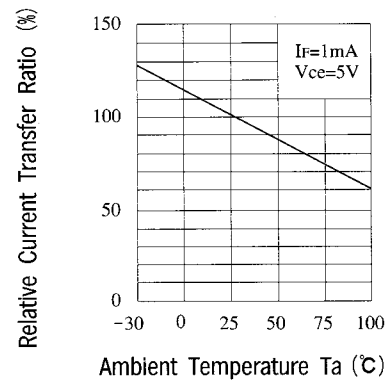

Fig 8 Collector-emitter Saturation Voltage vs. Ambient Temperature

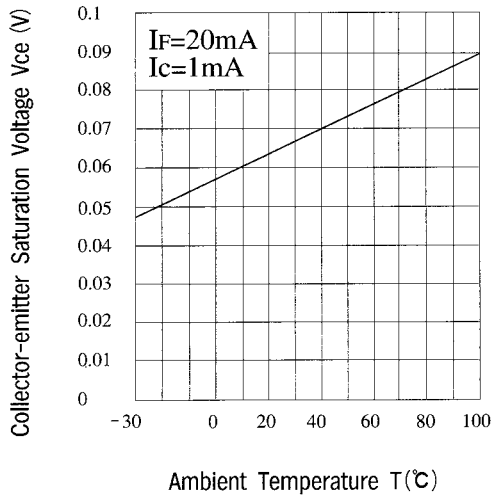

Fig 9 Collector-emitter Saturation Voltage vs. Forward Current

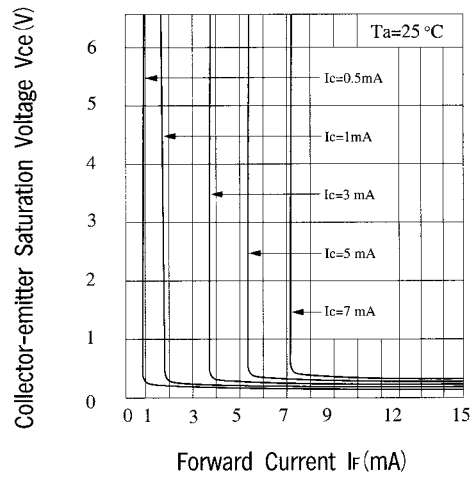

Fig 10 Response Time vs. Load Resistance

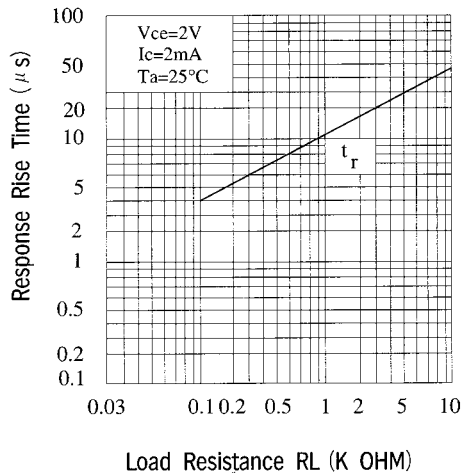

Fig 11 Response Time vs. Load Resistance

