

M3000 and M4000 SERIES

Single output

- Load currents up to 800A
- 3 phase or single phase input
- Shutdown on phase loss
- 3 phase power factor correction
- Single wire current share to 5%
- Ideal for N+1 applications
- Current monitor output included
- UL, CSA and TÜV safety approvals



[2 YEAR WARRANTY]

The M series is a range of single output, high current power supplies ideally suited to a broad range of applications. Robust performance and field proven reliability are hallmarks of this series. Field reliability in excess of 100,000 hours has been documented. The M series will provide stable power for any large electronic system including telecommunication, data processing and industrial. Typical applications include broadcast systems, ATM systems and RISC processors and systems. Semiconductor test equipment, semiconductor and wafer processing equipment and functional board level testers are other possible applications. Industrial uses include applications such as laser cutting, water purification, battery charging, machine control, large scale data logging and optical inspection equipment. Current sharing, built-in current monitoring, voltage margining and remote adjustment capability are standard features. Other system interface features include AC and DC good, OVP, OCP, over temperature protection and remote enable. Worldwide safety certifications are included.

SPECIFICATION All specifications are typical at nominal input, full load at 25°C unless otherwise stated

OUTPUT SPECIFICATIONS		
Voltage adjustability	Accessible at front panel	±10%
Remote sense	Open/reverse sense lead protection Compensates for voltage drop of up to 0.5V to the load	
Regulation, line or load	All outputs, NL to FL at nominal line or all line variations at FL	±0.2%; 10mV
Overshoot/undershoot		None at turn on/off
Transient response	Main output 25% step load change at 1A/μs	≤5.0% max. dev., ≤200μs recovery to 1.0%
Temperature coefficient		0.02%/°C
Ripple and noise	0Hz to 20MHz	100mV pk-pk or 1.0%
Overvoltage protection	Reset by cycling AC	115% to 130% of nominal
Overload protection		105% to 115% full load
Short circuit protection	90% of rated load	Auto recovery
Thermal protection		Auto shutdown, AC reset
Current sharing	±5.0%	50% to 100% load
Current monitor (V1)	5VDC at full load	±0.5V
INPUT SPECIFICATIONS		
Input voltage range	3 phase 1 phase (optional)	180 to 264VAC 180 to 264VAC
Input frequency range		47Hz to 63Hz
Input surge current		Meets IEEE std. 587.1980; 3KV ring wave
Input current	208VAC, 3 phase 208VAC, 1 phase	12A 27A
Power factor	3 phase 1 phase	0.94 0.65
Power up time	Full load	1.0s max.

EMC CHARACTERISTICS		
Radiated emissions	EN55022/11, FCC part 15	Level A
Conducted emissions	EN55022/11, FCC part 15	Level A
Electrostatic discharge	EN61000-4-2	Level 3
RF field susceptibility	EN61000-4-3	Level 3
Electrical fast transients/bursts	EN61000-4-4	Level 3
Surge susceptibility	EN61000-4-5	Level 3
GENERAL SPECIFICATIONS		
Hold-up time	230VAC, 3KW load	25ms min.
Efficiency	208VAC, 3 phase	83%
Isolation voltage	Input/output Input/chassis Output/output	3000VAC 1500VAC 500VAC
Switching frequency		100kHz
Approvals and standards		TÜV EN60950, UL1950, CSA C22.2 No. 950
Weight		13kg (29lbs)
Size		5 x 8 x 13.5 inches 127 x 203.2 x 342.9 mm
MTBF		>100,000 hours
ENVIRONMENTAL SPECIFICATIONS		
Thermal performance	Operating ambient Non-operating	0°C to +50°C -15°C to +85°C
Cooling	50CFM	Internal DC ball bearing fans
Relative humidity	Non-condensing	0% to 95% RH
Altitude	Operating Non-operating	6,000 feet max. 55,000 feet max.
Vibration	5Hz to 500Hz	2.4G rms peak

3000 and 4000 Watt AC/DC high current power supplies with PFC

MAX. OUTPUT POWER	INPUT VOLTAGE ⁽³⁾	OUTPUT VOLTAGE	OUTPUT CURRENT	MODEL NUMBER ⁽³⁾
3000W	Single Phase	2V	600A	M3000-26-0
3000W	Single Phase	3.3V	600A	M3000-26-9
3000W	Single Phase	5V	600A	M3000-26-1
3000W	Single Phase	12V	250A	M3000-26-2
3000W	Single Phase	15V	200A	M3000-26-3
3000W	Single Phase	24V	125A	M3000-26-4
3000W	Single Phase	28V	107A	M3000-26-5
3000W	Single Phase	48V	63A	M3000-26-6
3000W	Three Phase	2V	600A	M3000-86-0
3000W	Three Phase	3.3V	600A	M3000-86-9
3000W	Three Phase	5V	600A	M3000-86-1
3000W	Three Phase	12V	250A	M3000-86-2
3000W	Three Phase	15V	200A	M3000-86-3
3000W	Three Phase	24V	125A	M3000-86-4
3000W	Three Phase	28V	107A	M3000-86-5
3000W	Three Phase	48V	63A	M3000-86-6
4000W	Three Phase	2V	800A	M4000-86-0
4000W	Three Phase	3.3V	800A	M4000-86-9

STANDARD CONTROL SIGNALS	
Remote Enable	See Figure 1A
DC OK (See Figures 2, 5)	Signal remains "Hi" as long as output is $\pm 5.0\%$ of nominal
AC Good (See Figures 2, 5)	Signal "Hi" when AC > 175VAC and "Lo" when < 175VAC
Margin Hi/Lo (V1) (See Figure 3)	Switch closure allows $\pm 5.0\%$ change in output for system margin checking
Remote Adjust (See Figure 4)	The outputs may be remotely adjusted linearly $\pm 10\%$ for system margin checking
Current Monitor	Analog signal indicates load current in single or parallel operation. $5 \pm 0.5VDC$ represents FL, resistive load $10^3k\Omega$
Supply Fault	Overvoltage, overtemperature indicated by 'low' signal

Notes

- Units available with 4.5V, 5.2V, 10V, 13V, 20V, 30V and 32V. Please consult factory for further details.
- Consult factory for any output voltage requirement up to 60VDC which is not listed.
- Models with '-26' are single phase input; '-86' indicates 3 phase input.

FIG. 5

AC Power Fail Signal/DC OK Timing

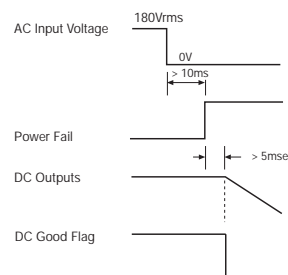

FIG. 1A

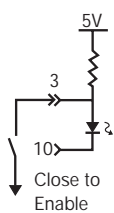

FIG. 1B

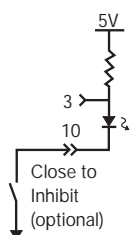

FIG. 2 (Ref. FIG. 5)

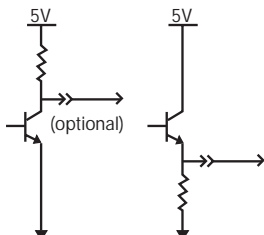

FIG. 3

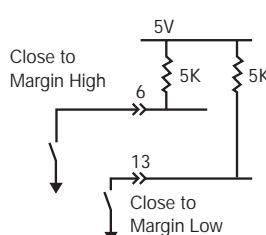
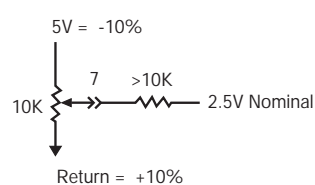

FIG. 4



3000 and 4000 Watt AC/DC high current power supplies with PFC

OUTPUT PIN CONNECTIONS		
PIN NO.	J1	REFERENCE
1	+ Remote Sense	Note 1
2	- Remote Sense	Note 1
3	Enable	Notes 2 & 4, Fig. 1
4	DC OK Inverse (Optional)	Notes 3 & 4, Fig. 2
5	AC Good Inverse	Notes 3 & 4, Fig. 2
6	Margin High	Fig. 3
7	Remote Adjust	Fig. 4
8	Current Monitor	Note 6
9	Current Share	Note 6
10	Inhibit (Optional)	Notes 2 & 4, Fig. 1
11	DC OK	Notes 3 & 4, Fig. 2 & 5
12	AC Good	Notes 3 & 4, Fig. 2 & 5
13	Margin Low	Note 3
14	Supply Fault	Notes 5 & 6
15	- Remote Sense	

Mechanical notes

- A AC connector is 4 position terminal block (#8 screws included), mating to #8 ring tongue terminal.
- B DC output is 5/16-18 studs mating to 5/16 terminal lugs.
- C J-1 signal connector is Molex 39-30-1140 or equivalent. Mating connector is Molex 39-01-2140 or equivalent.
- D J-2 signal connector is Molex 39-01-1120 or equivalent. Mating connector is 39-01-2120 or equivalent.
- E Signal connector contacts are Molex 39-00-0039 or equivalent.
- F Auxiliary DC output(s) are 6 position terminal block (#8 screws included) mating to #8 ring tongue terminal.
- G TB1 and J2 are not installed on single output models.

Output pin connector notes

- 1 Use 20AWG or larger twisted pair.
- 2 Switch on voltage must be <0.5V @ 5mA.
- 3 Figure 2 transistor on when signal TRUE. On voltage is <0.5V @ 5mA.
- 4 VCC in figures 1 and 2 is supplied internally; ground is pin 15.
- 5 Overvoltage and overtemperature will force fault TRUE. On voltage is <0.5V @ 5mA.
- 6 All I/O signals are referenced to pin 15.

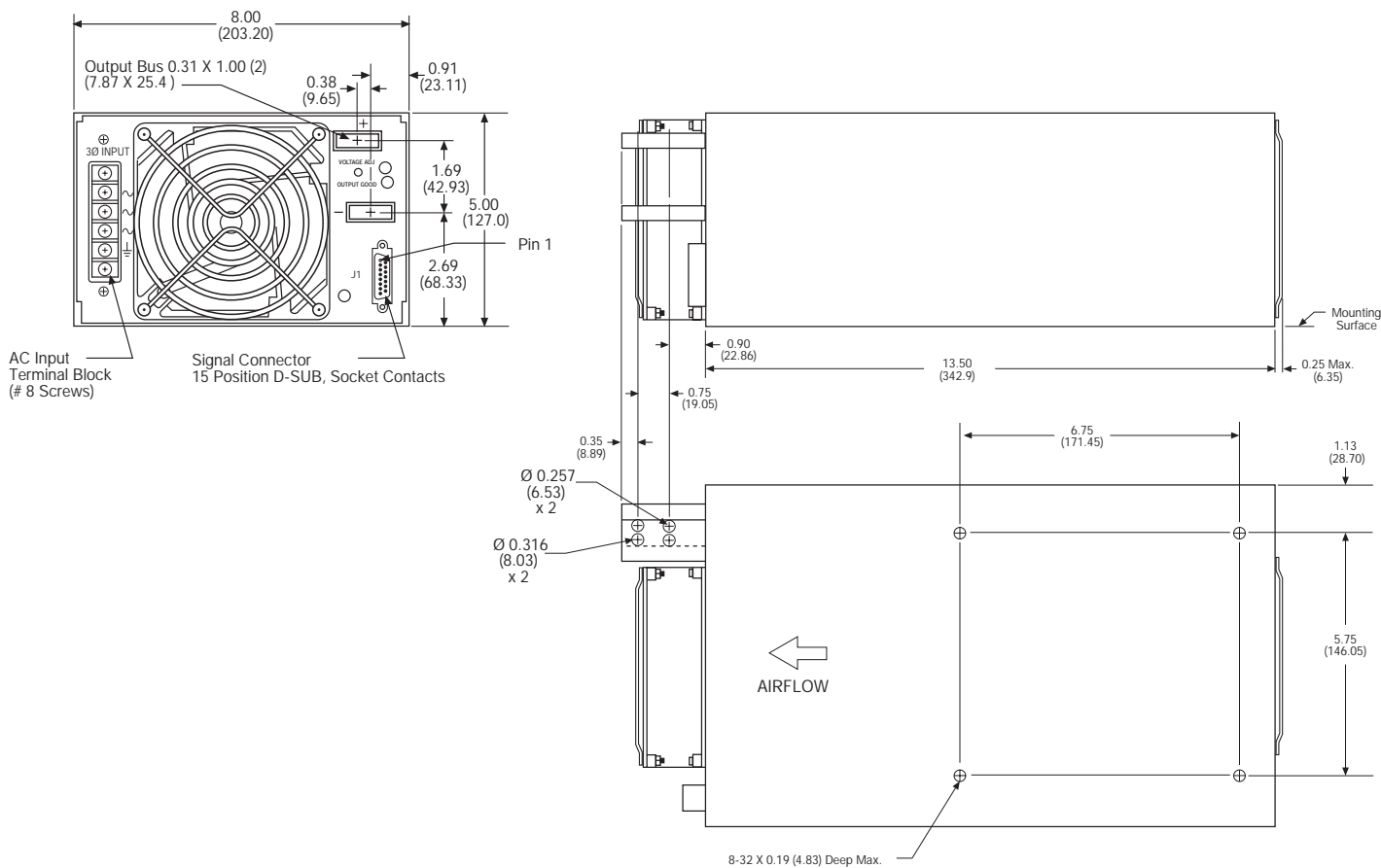

ALL DIMENSIONS IN INCHES (mm)

3000 and 4000 Watt AC/DC high current power supplies with PFC

EFFICIENCY V'S OUTPUT CURRENT

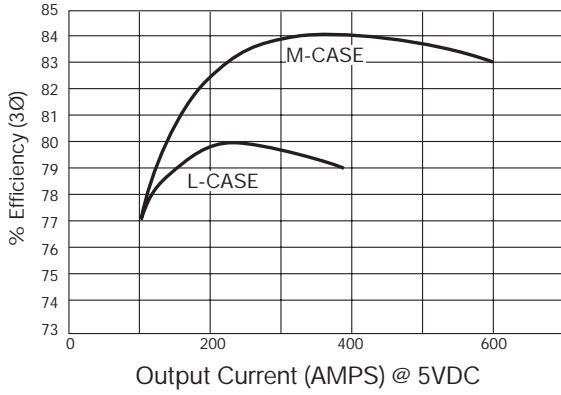

TRANSIENT RESPONSE

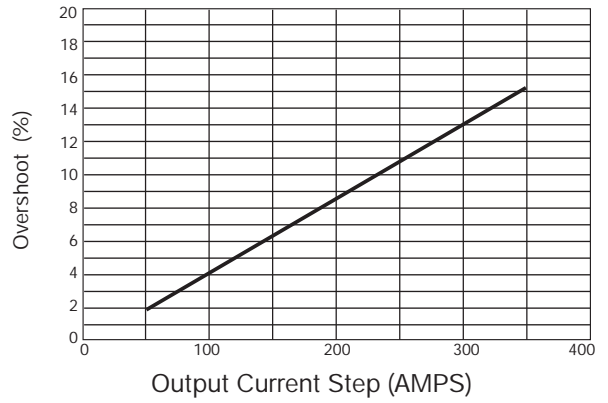

POWER FACTOR V'S OUTPUT CURRENT

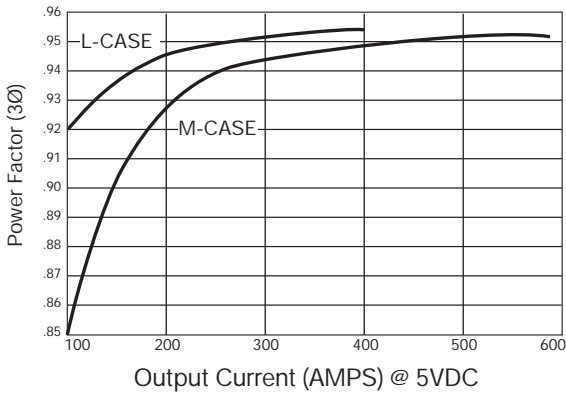

International Safety Standard Approvals

TÜV VDE0805/EN60950/IEC950 File No. R9373263

UL1950 File No. E135734

CSA C22.2 No. 950 Bulletin No. 1402C