

AD5532B—SPECIFICATIONS

($V_{DD} = +8\text{ V to }+16.5\text{ V}$, $V_{SS} = -4.75\text{ V to }-16.5\text{ V}$; $AV_{CC} = +4.75\text{ V to }+5.25\text{ V}$; $DV_{CC} = +2.7\text{ V to }+5.25\text{ V}$; $AGND = DGND = DAC_GND = 0\text{ V}$; $REF_IN = 3\text{ V}$; $OFFS_IN = 0\text{ V}$; Output Range from $V_{SS} + 2\text{ V}$ to $V_{DD} - 2\text{ V}$. All outputs unloaded. All specifications T_{MIN} to T_{MAX} , unless otherwise noted.)

Parameter ¹	AD5532B-1 B Version ²	Unit	Conditions/ Comments
DAC DC PERFORMANCE			
Resolution	14	Bits	
Integral Nonlinearity (INL)	± 0.39	% of FSR max	$\pm 0.15\%$ typ
Differential Nonlinearity (DNL)	± 1	LSB max	± 0.5 LSB typ Monotonic
Offset	90/170/250	mV min/typ/max	See Figure 6.
Gain	3.52	typ	
Full-Scale Error	$-1/+0.5$	% of FSR max	
ISHA DC PERFORMANCE			
V_{IN} to V_{OUT} Nonlinearity ³	± 0.006	% typ	After Offset and Gain Adjustment
	± 0.018	% max	
Total Unadjusted Error (TUE)	± 2.5	mV typ	See TPC 6.
	± 12	mV max	
Offset Error	± 1	mV typ	
	± 10	mV max	
Gain	3.51/3.52/3.53	min/typ/max	
ISHA ANALOG INPUT (V_{IN})			
Input Voltage Range	0 to 3	V	Nominal Input Range
Input Lower Dead Band	70	mV max	50 mV typ. Referred to V_{IN} . See Figure 7.
Input Upper Dead Band	40	mV max	12 mV typ. Referred to V_{IN} . See Figure 7.
Input Current	1	μA max	100 nA typ. V_{IN} acquired on one channel.
Input Capacitance ⁴	20	pF typ	
ANALOG INPUT (OFFS_IN)			
Input Current	1	μA max	100 nA typ
Input Voltage Range	0/4	V min/max	Output Range Restricted from $V_{SS} + 2\text{ V}$ to $V_{DD} - 2\text{ V}$
VOLTAGE REFERENCE			
REF_IN			
Nominal Input Voltage	3.0	V typ	
Input Voltage Range ⁴	2.85/3.15	V min/max	
Input Current	1	μA max	<1 nA typ
REF_OUT			
Output Voltage	3	V typ	
Output Impedance ⁴	280	k Ω typ	
Reference Temperature Coefficient ⁴	60	ppm/ $^{\circ}\text{C}$ typ	
ANALOG OUTPUTS (V_{OUT} 0–31)			
Output Temperature Coefficient ^{4, 5}	10	ppm/ $^{\circ}\text{C}$ typ	
DC Output Impedance ⁴	0.5	Ω typ	
Output Range	$V_{SS} + 2/V_{DD} - 2$	V min/max	100 μA Output Load
Resistive Load ^{4, 6}	5	k Ω min	
Capacitive Load ^{4, 6}	100	pF max	
Short-Circuit Current ⁴	7	mA typ	
DC Power-Supply Rejection Ratio ⁴	-70	dB	$V_{DD} = +15\text{ V} \pm 5\%$
	-70	dB	$V_{SS} = -15\text{ V} \pm 5\%$
DC Crosstalk ⁴	250	μV max	Outputs Loaded
ANALOG OUTPUT (OFFS_OUT)			
Output Temperature Coefficient ^{4, 5}	10	ppm/ $^{\circ}\text{C}$ typ	
DC Output Impedance ⁴	1.3	k Ω typ	
Output Range	50 to $REF_IN - 12$	mV typ	
Output Current	10	μA max	Source Current
Capacitive Load	100	pF max	

Parameter ¹	AD5532B-1 B Version ²	Unit	Conditions/Comments
DIGITAL INPUTS⁷			
Input Current	±10	µA max	±5 µA typ
Input Low Voltage	0.8	V max	DV _{CC} = 5 V ± 5%
	0.4	V max	DV _{CC} = 3 V ± 10%
Input High Voltage	2.4	V min	DV _{CC} = 5 V ± 5%
	2.0	V min	DV _{CC} = 3 V ± 10%
Input Hysteresis (SCLK and $\overline{\text{CS}}$ Only)	200	mV typ	
Input Capacitance	10	pF max	
DIGITAL OUTPUTS ($\overline{\text{BUSY}}$, D_{OUT})⁷			
Output Low Voltage, DV _{CC} = 5 V	0.4	V max	Sinking 200 µA
Output High Voltage, DV _{CC} = 5 V	4.0	V min	Sourcing 200 µA
Output Low Voltage, DV _{CC} = 3 V	0.4	V max	Sinking 200 µA
Output High Voltage, DV _{CC} = 3 V	2.4	V min	Sourcing 200 µA
High Impedance Leakage Current	±1	µA max	D _{OUT} Only
High Impedance Output Capacitance	15	pF typ	D _{OUT} Only
POWER REQUIREMENTS			
Power Supply Voltages			
V _{DD}	8/16.5	V min/max	
V _{SS}	-4.75/-16.5	V min/max	
AV _{CC}	4.75/5.25	V min/max	
DV _{CC}	2.7/5.25	V min/max	
Power Supply Currents ⁸			
I _{DD}	15	mA max	10 mA typ. All channels full-scale.
I _{SS}	15	mA max	10 mA typ. All channels full-scale.
AICC	33	mA max	26 mA typ
DICC	1.5	mA max	1 mA typ
Power Dissipation ⁸	280	mW typ	V _{DD} = +10 V, V _{SS} = -5 V

NOTES

¹See Terminology section.²B Version: Industrial temperature range -40°C to +85°C; typical at +25°C.³Input range 100 mV to 2.96 V.⁴Guaranteed by design and characterization, not production tested.⁵AD780 as reference for the AD5532B.⁶Ensure that you do not exceed T_J (max). See Absolute Maximum Ratings section.⁷Guaranteed by design and characterization, not production tested.⁸Output unloaded.

Specifications subject to change without notice.

AD5532B

AC CHARACTERISTICS ($V_{DD} = +8\text{ V to }+16.5\text{ V}$, $V_{SS} = -4.75\text{ V to }-16.5\text{ V}$; $AV_{CC} = +4.75\text{ V to }+5.25\text{ V}$; $DV_{CC} = +2.7\text{ V to }+5.25\text{ V}$; $AGND = DGND = DAC_GND = 0\text{ V}$; $REF_IN = 3\text{ V}$; $OFF_IN = 0\text{ V}$; All specifications T_{MIN} to T_{MAX} , unless otherwise noted.)

Parameter ¹	AD5532B-1 B Version ²	Unit	Conditions/Comments
DAC AC CHARACTERISTICS³			
Output Voltage Settling Time	22	$\mu\text{s max}$	500 pF, 5 k Ω Load Full-Scale Change
OFFS_IN Settling Time	10	$\mu\text{s max}$	500 pF, 5 k Ω Load; 0 V to 3 V Step
Digital-to-Analog Glitch Impulse	1	nV-s typ	1 LSB Change Around Major Carry
Digital Crosstalk	5	nV-s typ	
Analog Crosstalk	1	nV-s typ	
Digital Feedthrough	0.2	nV-s typ	
Output Noise Spectral Density @ 1 kHz	400	nV/ $\sqrt{\text{Hz}}$ typ	
ISHA AC CHARACTERISTICS			
Output Voltage Settling Time ³	3	$\mu\text{s max}$	Outputs Unloaded
Acquisition Time	16	$\mu\text{s max}$	
AC Crosstalk ³	5	nV-s typ	

NOTES

¹See Terminology section.

²B Version: Industrial temperature range -40°C to $+85^{\circ}\text{C}$; typical at $+25^{\circ}\text{C}$.

³Guaranteed by design and characterization, not production tested.

Specifications subject to change without notice.

TIMING CHARACTERISTICS

PARALLEL INTERFACE

Parameter ^{1, 2}	Limit at T_{MIN} , T_{MAX} (B Version)	Unit	Conditions/Comments
t_1	0	ns min	$\overline{\text{CS}}$ to $\overline{\text{WR}}$ Setup Time
t_2	0	ns min	$\overline{\text{CS}}$ to $\overline{\text{WR}}$ Hold Time
t_3	50	ns min	$\overline{\text{CS}}$ Pulsewidth Low
t_4	50	ns min	$\overline{\text{WR}}$ Pulsewidth Low
t_5	20	ns min	A4–A0, CAL, OFFS_SEL to $\overline{\text{WR}}$ Setup Time
t_6	7	ns min	A4–A0, CAL, OFFS_SEL to $\overline{\text{WR}}$ Hold Time

NOTES

¹See Parallel Interface Timing Diagram.

²Guaranteed by design and characterization, not production tested.

Specifications subject to change without notice.

SERIAL INTERFACE

Parameter ^{1, 2}	Limit at T_{MIN} , T_{MAX} (B Version)	Unit	Conditions/Comments
f_{CLKIN} ³	14	MHz max	SCLK Frequency
t_1	28	ns min	SCLK High Pulsewidth
t_2	28	ns min	SCLK Low Pulsewidth
t_3	15	ns min	$\overline{\text{SYNC}}$ Falling Edge to SCLK Falling Edge Setup Time
t_4	50	ns min	$\overline{\text{SYNC}}$ Low Time
t_5	15	ns min	D_{IN} Setup Time
t_6	5	ns min	D_{IN} Hold Time
t_7	5	ns min	$\overline{\text{SYNC}}$ Falling Edge to SCLK Rising Edge Setup Time for Readback
t_8 ⁴	20	ns max	SCLK Rising Edge to D_{OUT} Valid
t_9 ⁴	60	ns max	SCLK Falling Edge to D_{OUT} High Impedance
t_{10}	400	ns min	10th SCLK Falling Edge to $\overline{\text{SYNC}}$ Falling Edge for Readback
t_{11}	400	ns min	24th SCLK Falling Edge to $\overline{\text{SYNC}}$ Falling Edge for DAC Mode Write
t_{12} ⁵	7	ns min	SCLK Falling Edge to $\overline{\text{SYNC}}$ Falling Edge for Readback

NOTES

¹See Serial Interface Timing Diagrams.

²Guaranteed by design and characterization, not production tested.

³In ISHA mode the maximum SCLK frequency is 20 MHz and the minimum pulsewidth is 20 ns.

⁴These numbers are measured with the load circuit of Figure 2.

⁵ $\overline{\text{SYNC}}$ should be taken low while SCLK is low for readback.

Specifications subject to change without notice.

PARALLEL INTERFACE TIMING DIAGRAM

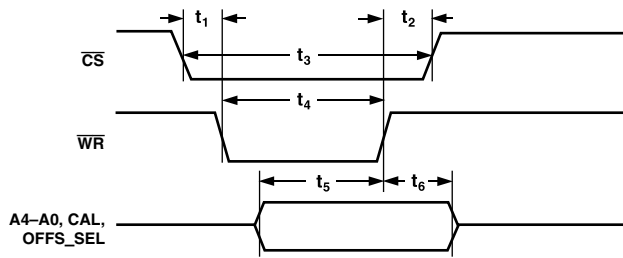

Figure 1. Parallel Write (ISHA Mode Only)

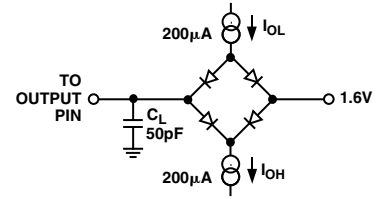

Figure 2. Load Circuit for D_{OUT} Timing Specifications

SERIAL INTERFACE TIMING DIAGRAMS

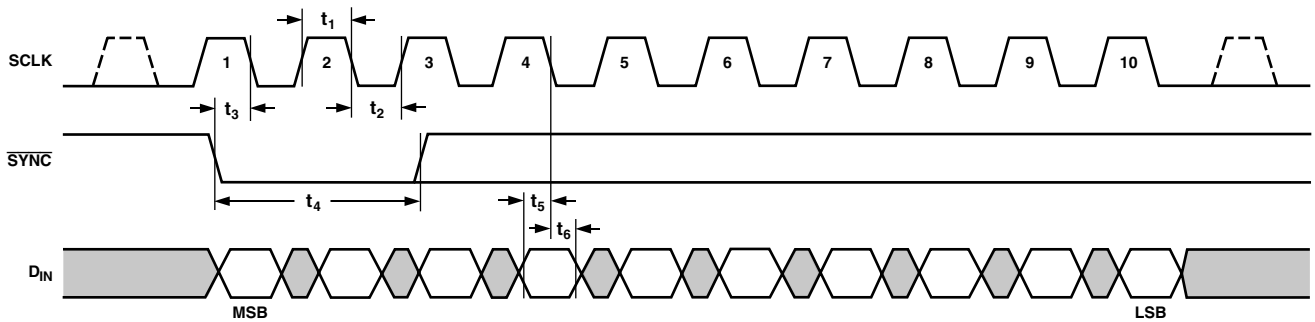

Figure 3. 10-Bit Write (ISHA Mode and Both Readback Modes)

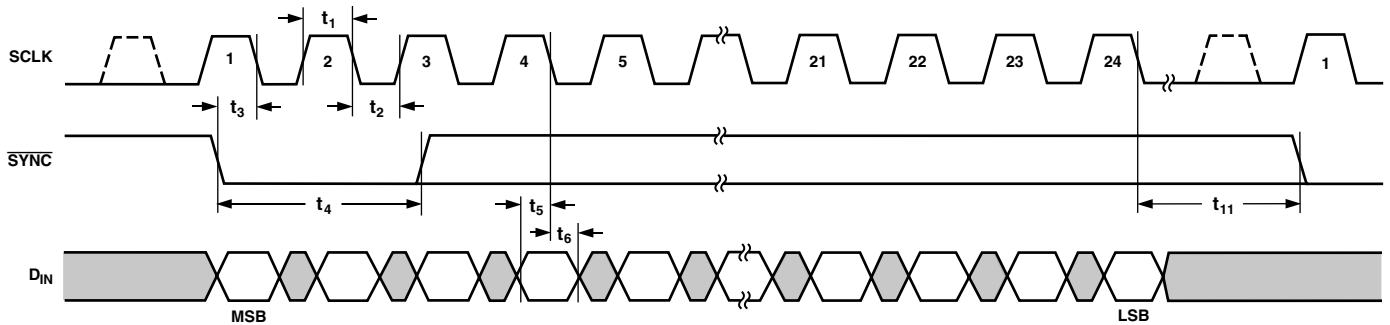

Figure 4. 24-Bit Write (DAC Mode)

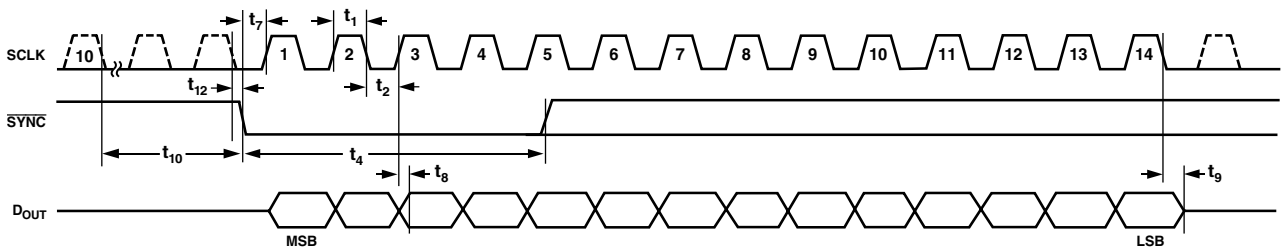

Figure 5. 14-Bit Read (Both Readback Modes)

AD5532B

ABSOLUTE MAXIMUM RATINGS^{1,2}

(T_A = 25°C, unless otherwise noted.)

V _{DD} to AGND	−0.3 V to +17 V
V _{SS} to AGND	+0.3 V to −17 V
AV _{CC} to AGND, DAC_GND	−0.3 V to +7 V
DV _{CC} to DGND	−0.3 V to +7 V
Digital Inputs to DGND	−0.3 V to DV _{CC} + 0.3 V
Digital Outputs to DGND	−0.3 V to DV _{CC} + 0.3 V
REF_IN to AGND, DAC_GND	−0.3 V to AV _{CC} + 0.3 V
V _{IN} to AGND, DAC_GND	−0.3 V to AV _{CC} + 0.3 V
V _{OUT0–31} to AGND	V _{SS} − 0.3 V to V _{DD} + 0.3 V
OFFS_IN to AGND	V _{SS} − 0.3 V to V _{DD} + 0.3 V
OFFS_OUT to AGND	AGND − 0.3 V to AV _{CC} + 0.3 V
AGND to DGND	−0.3 V to +0.3 V
Operating Temperature Range	
Industrial	−40°C to +85°C
Storage Temperature Range	
	−65°C to +150°C
Junction Temperature (T_J max)	
	150°C
74-Lead CSPBGA Package, θ_{JA} Thermal Impedance	
	41°C/W
Reflow Soldering	
Peak Temperature	220°C
Time at Peak Temperature	10 sec to 40 sec
Max Power Dissipation	(150°C − T _A)/θ _{JA} mW ³

Max Continuous Load Current at T_J = 70°C,
per Channel Group 15.5 mA⁴

NOTES

¹ Stresses above those listed under Absolute Maximum Ratings may cause permanent damage to the device. This is a stress rating only; functional operation of the device at these or any other conditions above those listed in the operational sections of this specification is not implied. Exposure to absolute maximum rating conditions for extended periods may affect device reliability.

² Transient currents of up to 100 mA will not cause SCR latch-up.

³ This limit includes load power.

⁴ This maximum allowed continuous load current is spread over eight channels, with channels grouped as follows:

- Group 1: Channels 3, 4, 5, 6, 7, 8, 9, 10
- Group 2: Channels 14, 16, 18, 20, 21, 24, 25, 26
- Group 3: Channels 15, 17, 19, 22, 23, 27, 28, 29
- Group 4: Channels 0, 1, 2, 11, 12, 13, 30, 31

For higher junction temperatures, derate as follows:

T _J (°C)	Max Continuous Load Current per Group (mA)
70	1.55
90	9.025
100	6.925
110	5.175
125	3.425
135	2.55
150	1.5

ORDERING GUIDE

Model	Function	Output Impedance (Typ)	Output Voltage Span (V)	Package Description	Package Option
AD5532BBC-1	32 DACs, 32-Channel Precision ISHA	0.5 Ω	10	74-Lead CSPBGA	BC-74
AD5532ABC-1*	32 DACs, 32-Channel ISHA	0.5 Ω	10	74-Lead CSPBGA	BC-74
AD5532ABC-2*	32 DACs, 32-Channel ISHA	0.5 Ω	20	74-Lead CSPBGA	BC-74
AD5532ABC-3*	32 DACs, 32-Channel ISHA	500 Ω	10	74-Lead CSPBGA	BC-74
AD5532ABC-5*	32 DACs, 32-Channel ISHA	1 kΩ	10	74-Lead CSPBGA	BC-74
AD5533ABC-1*	32-Channel ISHA Only	0.5 Ω	10	74-Lead CSPBGA	BC-74
AD5533BBC-1*	32-Channel Precision ISHA Only	0.5 Ω	10	74-Lead CSPBGA	BC-74
EVAL-AD5532EB	Evaluation Board				

*Separate Data Sheet.

CAUTION

ESD (electrostatic discharge) sensitive device. Electrostatic charges as high as 4000 V readily accumulate on the human body and test equipment and can discharge without detection. Although the AD5532B features proprietary ESD protection circuitry, permanent damage may occur on devices subjected to high energy electrostatic discharges. Therefore, proper ESD precautions are recommended to avoid performance degradation or loss of functionality.



PIN CONFIGURATION

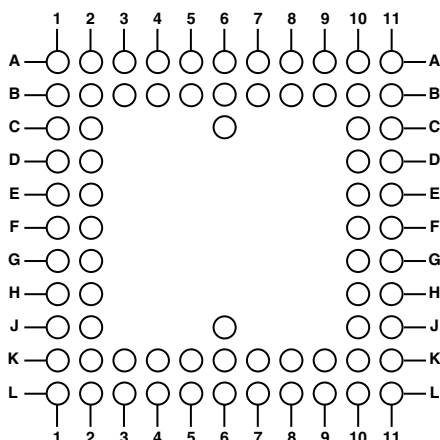

74-Lead CSPBGA Ball Configuration

CSPBGA Number	Ball Name	CSPBGA Number	Ball Name	CSPBGA Number	Ball Name
A1	NC*	C10	AVCC1	J10	VO9
A2	A4	C11	REF_OUT	J11	VO11
A3	A2	D1	VO20	K1	VO17
A4	A0	D2	DAC_GND2	K2	VO15
A5	$\overline{\text{CS/SYNC}}$	D10	AVCC2	K3	VO27
A6	DVCC	D11	OFFS_OUT	K4	VSS3
A7	SCLK	E1	VO26	K5	VSS1
A8	OFFSET_SEL	E2	VO14	K6	VSS4
A9	BUS $\overline{\text{Y}}$	E10	AGND1	K7	VDD2
A10	$\overline{\text{TRACK/RESET}}$	E11	OFFS_IN	K8	VO2
A11	NC*	F1	VO25	K9	VO10
B1	VO16	F2	VO21	K10	VO13
B2	NC*	F10	AGND2	K11	VO12
B3	A3	F11	VO6	L1	NC*
B4	A1	G1	VO24	L2	VO28
B5	$\overline{\text{WR}}$	G2	VO8	L3	VO29
B6	DGND	G10	VO5	L4	VO30
B7	D _{IN}	G11	VO3	L5	VDD3
B8	CAL	H1	VO23	L6	VDD1
B9	$\overline{\text{SER/PAR}}$	H2	VIN	L7	VDD4
B10	DOUT	H10	VO4	L8	VO31
B11	REF_IN	H11	VO7	L9	VO0
C1	VO18	J1	VO22	L10	VO1
C2	DAC_GND1	J2	VO19	L11	NC*
C6	NC*	J6	VSS2		

*NC = Not Connected

PIN FUNCTION DESCRIPTIONS

Mnemonic	Description
AGND (1-2)	Analog GND Pins
AV _{CC} (1-2)	Analog Supply Pins. Voltage range from 4.75 V to 5.25 V.
V _{DD} (1-4)	V _{DD} Supply Pins. Voltage range from 8 V to 16.5 V.
V _{SS} (1-4)	V _{SS} Supply Pins. Voltage range from -4.75 V to -16.5 V.
DGND	Digital GND Pins
DV _{CC}	Digital Supply Pins. Voltage range from 2.7 V to 5.25 V.
DAC_GND (1-2)	Reference GND Supply for all the DACs
REF_IN	Reference Voltage for Channels 0-31
REF_OUT	Reference Output Voltage
V _{OUT} (0-31)	Analog Output Voltages from the 32 Channels
V _{IN}	Analog Input Voltage. Connect this to AGND if operating in DAC mode only.
A4-A1 ¹ , A0 ²	Parallel Interface. 5-address pins for 32 channels. A4 = MSB of channel address. A0 = LSB.
CAL ¹	Parallel Interface. Control input that allows all 32 channels to acquire V _{IN} simultaneously.
$\overline{\text{CS/SYNC}}$	This pin is both the active low chip select pin for the parallel interface and the frame synchronization pin for the serial interface.
$\overline{\text{WR}}$ ¹	Parallel Interface. Write pin. Active low. This is used in conjunction with the $\overline{\text{CS}}$ pin to address the device using the parallel interface.
OFFSET_SEL ¹	Parallel Interface. Offset select pin. Active high. This is used to select the offset channel.
SCLK ²	Serial Clock Input for Serial Interface. This operates at clock speeds up to 14 MHz (20 MHz in ISHA mode).
D _{IN} ²	Data Input for Serial Interface. Data must be valid on the falling edge of SCLK.
D _{OUT}	Output from the DAC Registers for Readback. Data is clocked out on the rising edge of SCLK and is valid on the falling edge of SCLK.
SER/ $\overline{\text{PAR}}$ ¹	This pin allows the user to select whether the serial or parallel interface will be used. If the pin is tied low, the parallel interface will be used. If it is tied high, the serial interface will be used.
OFFS_IN	Offset Input. The user can supply a voltage here to offset the output span. OFFS_OUT can also be tied to this pin if the user wants to drive this pin with the offset channel.
OFFS_OUT	Offset Output. This is the acquired/programmed offset voltage that can be tied to OFFS_IN to offset the span.
$\overline{\text{BUSY}}$	This output tells the user when the input voltage is being acquired. It goes low during acquisition and returns high when the acquisition operation is complete.
$\overline{\text{TRACK/RESET}}$ ²	If this input is held high, V _{IN} is acquired once the channel is addressed. While it is held low, the input to the gain/offset stage is switched directly to V _{IN} . The addressed channel begins to acquire V _{IN} on the rising edge of $\overline{\text{TRACK}}$. See $\overline{\text{TRACK}}$ Input section for further information. This input can also be used as a means of resetting the complete device to its power-on-reset conditions. This is achieved by applying a low going pulse of between 90 ns and 200 ns to this pin. See section on RESET Function for further details.

NOTES

¹Internal pull-down devices on these logic inputs. Therefore, they can be left floating and will default to a logic low condition.

²Internal pull-up devices on these logic inputs. Therefore, they can be left floating and will default to a logic high condition.

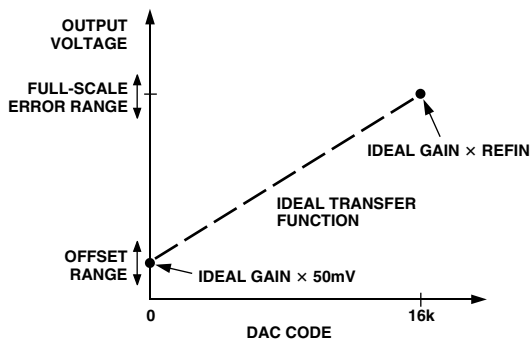

Figure 6. DAC Transfer Function (OFFS_IN = 0)

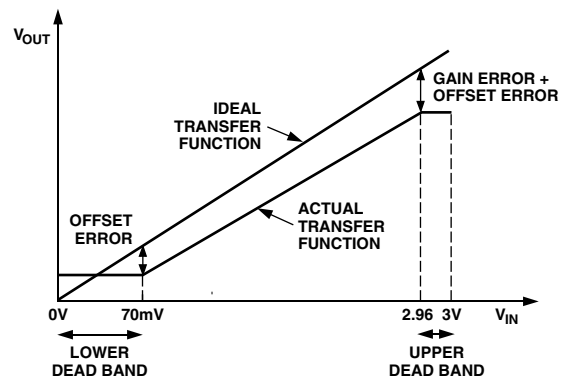

Figure 7. ISHA Transfer Function

TERMINOLOGY**DAC MODE****Integral Nonlinearity (INL)**

This is a measure of the maximum deviation from a straight line passing through the endpoints of the DAC transfer function. It is expressed as a percentage of full-scale span.

Differential Nonlinearity (DNL)

Differential nonlinearity (DNL) is the difference between the measured change and the ideal 1 LSB change between any two adjacent codes. A specified DNL of ± 1 LSB maximum ensures monotonicity.

Offset

Offset is a measure of the output with all zeros loaded to the DAC and $OFFS_IN = 0$. Since each DAC is lifted off the ground by approximately 50 mV, this output will typically be:

$$V_{OUT} = GAIN \times 50 \text{ mV}$$

Full-Scale Error

This is a measure of the output error with all 1s loaded to the DAC. It is expressed as a percentage of full-scale range. It includes the offset error. See Figure 6. It is calculated as:

$$Full\text{-Scale Error} = V_{OUT(Full\ Scale)} - (Ideal\ Gain \times REF_{IN})$$

where

$$Ideal\ Gain = 3.52 \text{ for } AD5532B - 1$$

Output Settling Time

This is the time taken from when the last data bit is clocked into the DAC until the output has settled to within $\pm 0.39\%$.

OFFS_IN Settling Time

This is the time taken from a 0 V–3 V step change in input voltage on $OFFS_IN$ until the output has settled to within $\pm 0.39\%$.

Digital-to-Analog Glitch Impulse

This is the area of the glitch injected into the analog output when the code in the DAC register changes state. It is specified as the area of the glitch in nV-secs when the digital code is changed by 1 LSB at the major carry transition (011 . . . 11 to 100 . . . 00 or 100 . . . 00 to 011 . . . 11).

Digital Crosstalk

This is the glitch impulse transferred to the output of one DAC at midscale while a full-scale code change (all 1s to all 0s and vice versa) is being written to another DAC. It is expressed in nV-secs.

Analog Crosstalk

This is the area of the glitch transferred to the output (V_{OUT}) of one DAC due to a full-scale change in the output (V_{OUT}) of another DAC. The area of the glitch is expressed in nV-secs.

Digital Feedthrough

This is a measure of the impulse injected into the analog outputs from the digital control inputs when the part is not being written to, i.e., $\overline{CS/SYNC}$ is high. It is specified in nV-secs and is measured with a worst-case change on the digital input pins, e.g., from all 0s to all 1s and vice versa.

Output Noise Spectral Density

This is a measure of internally generated random noise. Random noise is characterized as a spectral density (voltage per root Hertz). It is measured by loading all DACs to midscale and measuring noise at the output. It is measured in nV/\sqrt{Hz} .

Output Temperature Coefficient

This is a measure of the change in analog output with changes in temperature. It is expressed in ppm/ $^{\circ}C$.

DC Power Supply Rejection Ratio

DC power supply rejection ratio (PSRR) is a measure of the change in analog output for a change in supply voltage (V_{DD} and V_{SS}). It is expressed in dBs. V_{DD} and V_{SS} are varied $\pm 5\%$.

DC Crosstalk

This is the change in the output level of one DAC at midscale in response to a full-scale code change (all 0s to all 1s and vice versa) and output change of all other DACs. It is expressed in μV .

ISHA MODE**Total Unadjusted Error (TUE)**

This is a comprehensive specification that includes relative accuracy, gain and offset errors. It is measured by sampling a range of voltages on V_{IN} and comparing the measured voltages on V_{OUT} to the ideal value. It is expressed in mV.

 V_{IN} to V_{OUT} Nonlinearity

This is a measure of the maximum deviation from a straight line passing through the endpoints of the V_{IN} versus V_{OUT} transfer function. It is expressed as a percentage of the full-scale span.

Offset Error

This is a measure of the output error when $V_{IN} = 70$ mV. Ideally, with $V_{IN} = 70$ mV:

$$V_{OUT} = (Gain \times 70) - [(Gain - 1) \times V_{OFFS_IN}] \text{ mV}$$

Offset error is a measure of the difference between V_{OUT} (actual) and V_{OUT} (ideal). It is expressed in mV and can be positive or negative. See Figure 7.

Gain Error

This is a measure of the span error of the analog channel. It is the deviation in slope of the transfer function expressed in mV. See Figure 7. It is calculated as:

$$Gain\ Error = Actual\ Full\text{-Scale}\ Output - Ideal\ Full\text{-Scale}\ Output - Offset\ Error$$

where

$$Ideal\ Full\text{-Scale}\ Output = (Gain \times 2.96) - [(Gain - 1) \times V_{OFFS_IN}]$$

AC Crosstalk

This is the area of the glitch that occurs on the output of one channel while another channel is acquiring. It is expressed in nV-secs.

Output Settling Time

This is the time taken from when \overline{BUSY} goes high to when the output has settled to $\pm 0.018\%$.

Acquisition Time

This is the time taken for the V_{IN} input to be acquired. It is the length of time that \overline{BUSY} stays low.

AD5532B—Typical Performance Characteristics

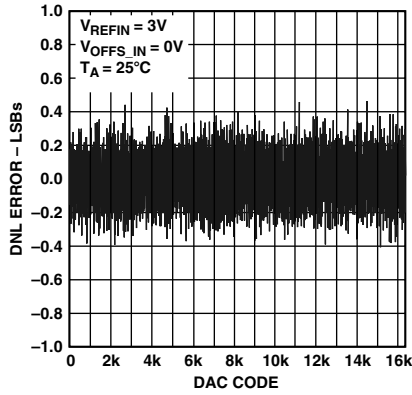

TPC 1. Typical DNL Plot

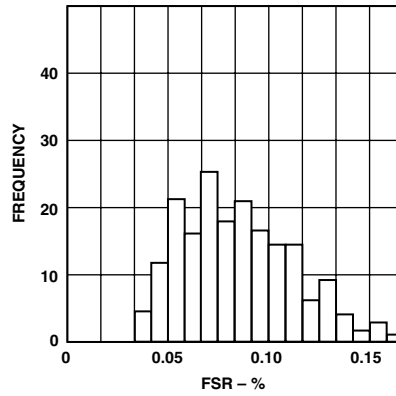

TPC 2. INL Error Distribution at 25°C (DAC Mode)

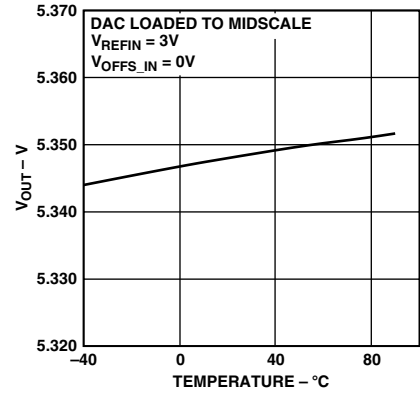

TPC 3. V_{OUT} vs. Temperature

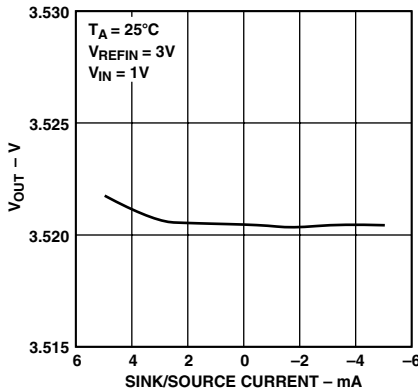

TPC 4. V_{OUT} Source and Sink Capability

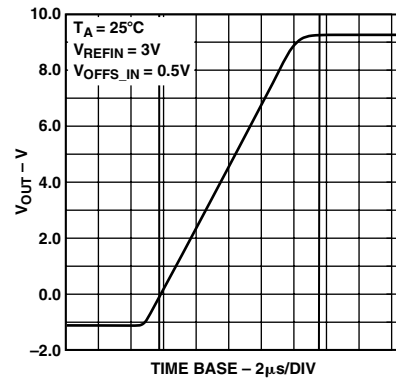

TPC 5. Full-Scale Settling Time

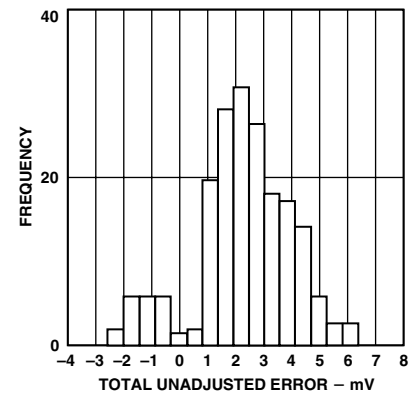

TPC 6. TUE Distribution at 25°C (ISHA Mode)

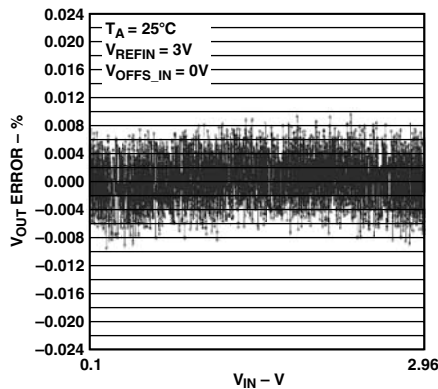

TPC 7. V_{IN} to V_{OUT} Accuracy After Offset and Gain Adjustment (ISHA Mode)

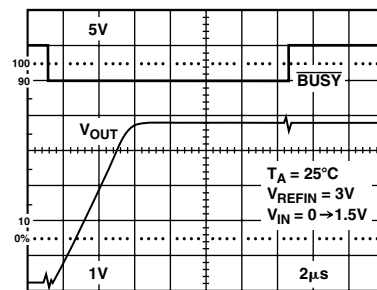

TPC 8. Acquisition Time and Output Settling Time (ISHA Mode)

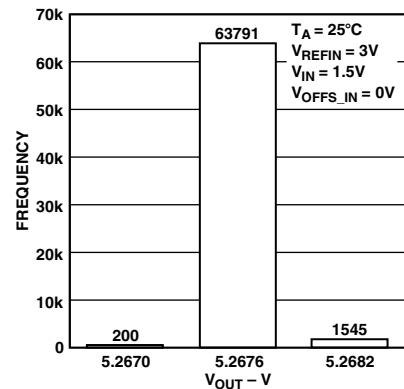

TPC 9. ISHA Mode Repeatability (64 K Acquisitions)

FUNCTIONAL DESCRIPTION

The AD5532B can be thought of as consisting of 32 DACs and an ADC (for ISHA mode) in a single package. In DAC mode, a 14-bit digital word is loaded into one of the 32 DAC registers via the serial interface. This is then converted (with gain and offset) into an analog output voltage (V_{OUT0} – V_{OUT31}).

To update a DAC's output voltage, the required DAC is addressed via the serial port. When the DAC address and code have been loaded, the selected DAC converts the code.

On power-on, all the DACs, including the offset channel, are loaded with zeros. Each of the 33 DACs is offset internally by 50 mV (typ) from GND so the outputs V_{OUT0} to V_{OUT31} are 50 mV (typ) on power-on if the OFFS_IN pin is driven directly by the on-board offset channel (OFFS_OUT), i.e., if $OFFS_IN = OFFS_OUT = 50\text{ mV} \Rightarrow V_{OUT} = (\text{Gain} \times V_{DAC}) - (\text{Gain} - 1) \times V_{OFFS_IN} = 50\text{ mV}$.

Output Buffer Stage—Gain and Offset

The function of the output buffer stage is to translate the 50 mV–3 V typical output of the DAC to a wider range. This is done by gaining up the DAC output by 3.52 and offsetting the voltage by the voltage on OFFS_IN pin.

$$V_{OUT} = 3.52 \times V_{DAC} - 2.52 \times V_{OFFS_IN}$$

V_{DAC} is the output of the DAC.

V_{OFFS_IN} is the voltage at the OFFS_IN pin.

Table I shows how the output range on V_{OUT} relates to the offset voltage supplied by the user:

Table I. Sample Output Voltage Ranges

V_{OFFS_IN} (V)	V_{DAC} (Typ) (V)	V_{OUT} (Typ) (V)
0	0.05 to 3	0.176 to 10.56
1	0.05 to 3	–2.34 to +8.04
2,130	0.05 to 3	–5.192 to +5.192

V_{OUT} is limited only by the headroom of the output amplifiers. V_{OUT} must be within maximum ratings.

Offset Voltage Channel

The offset voltage can be externally supplied by the user at OFFS_IN or it can be supplied by an additional offset voltage channel on the device itself. The offset can be set up in two ways. In ISHA mode the required offset voltage is set up on V_{IN} and acquired by the offset channel. In DAC mode, the code corresponding to the offset value is loaded directly into the offset DAC. This offset channel's DAC output is directly connected to the OFFS_OUT pin. By connecting OFFS_OUT to OFFS_IN this offset voltage can be used as the offset voltage for the 32 output amplifiers. The offset must be chosen so that V_{OUT} is within maximum ratings.

Reset Function

The reset function on the AD5532B can be used to reset all nodes on this device to their power-on-reset condition. This is implemented by applying a low going pulse of between 90 ns and 200 ns to the $\overline{\text{TRACK/RESET}}$ pin on the device. If the applied pulse is less than 90 ns, it is assumed to be a glitch and no operation takes place. If the applied pulse is wider than 200 ns, this pin adopts its track function on the selected channel, V_{IN} is switched to the output buffer, and an acquisition on the channel will not occur until a rising edge of $\overline{\text{TRACK}}$.

ISHA Mode

In ISHA mode the input voltage V_{IN} is sampled and converted into a digital word. The noninverting input to the output buffer (gain and offset stage) is tied to V_{IN} during the acquisition period to avoid spurious outputs while the DAC acquires the correct code. This is completed in 16 μs max. At this time, the updated DAC output assumes control of the output voltage. The output voltage of the DAC is connected to the noninverting input of the output buffer. Since the channel output voltage is effectively the output of a DAC, there is no droop associated with it. As long as power is maintained to the device, the output voltage will remain constant until this channel is addressed again. Since the internal DACs are offset by 70 mV (max) from GND, the minimum V_{IN} in ISHA mode is 70 mV. The maximum V_{IN} is 2.96 V due to the upper dead band of 40 mV (max).

Analog Input (ISHA Mode)

The equivalent analog input circuit is shown in Figure 8. The capacitor C1 is typically 20 pF and can be attributed to pin capacitance and 32 off-channels. When a channel is selected, an extra 7.5 pF (typ) is switched in. This capacitor C2 is charged to the previously acquired voltage on that particular channel so it must charge/discharge to the new level. It is essential that the external source can charge/discharge this additional capacitance within 1 μs to 2 μs of channel selection so that V_{IN} can be acquired accurately. For this reason a low impedance source is recommended.

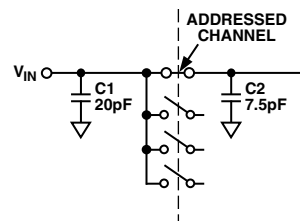

Figure 8. Analog Input Circuit

Large source impedances will significantly affect the performance of the ADC. This may necessitate the use of an input buffer amplifier.

$\overline{\text{TRACK}}$ Function (ISHA Mode)

Normally in ISHA mode of operation, $\overline{\text{TRACK}}$ is held high and the channel begins to acquire when it is addressed. However, if $\overline{\text{TRACK}}$ is low when the channel is addressed, V_{IN} is switched to the output buffer and an acquisition on the channel will not occur until a rising edge of $\overline{\text{TRACK}}$. At this stage the $\overline{\text{BUSY}}$ pin will go low until the acquisition is complete, at which point the DAC assumes control of the voltage to the output buffer and V_{IN} is free to change again without affecting this output value.

This is useful in an application where the user wants to ramp up V_{IN} until V_{OUT} reaches a particular level (Figure 9). V_{IN} does not need to be acquired continuously while it is ramping up. $\overline{\text{TRACK}}$ can be kept low and only when V_{OUT} has reached its desired voltage is $\overline{\text{TRACK}}$ brought high. At this stage, the acquisition of V_{IN} begins.

In the example shown, a desired voltage is required on the output of the pin driver. This voltage is represented by one input to a comparator. The microcontroller/microprocessor ramps up the input voltage on V_{IN} through a DAC. $\overline{\text{TRACK}}$ is kept low while the voltage on V_{IN} ramps up so that V_{IN} is not continually acquired. When the desired voltage is reached on the output

AD5532B

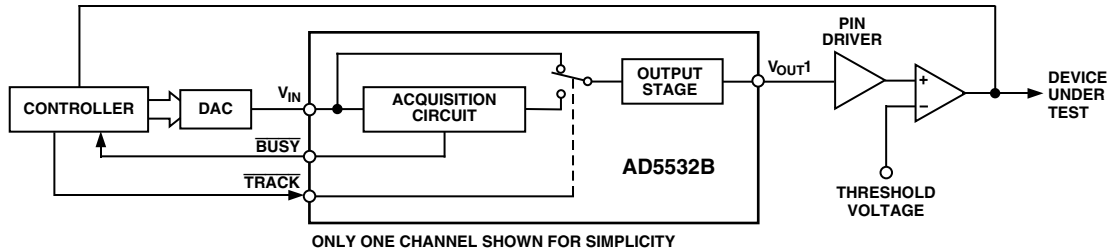

Figure 9. Typical ATE Circuit Using $\overline{\text{TRACK}}$ Input

of the pin driver, the comparator output switches. The $\mu\text{C}/\mu\text{P}$ then knows what code is required to be input in order to obtain the desired voltage at the DUT. The $\overline{\text{TRACK}}$ input is now brought high and the part begins to acquire V_{IN} . At this stage, $\overline{\text{BUSY}}$ goes low until V_{IN} has been acquired. The output buffer is then switched from V_{IN} to the output of the DAC.

MODES OF OPERATION

The AD5532B can be used in four different modes of operation. These modes are set by two mode bits, the first two bits in the serial word.

Table II. Modes of Operation

Mode Bit 1	Mode Bit 2	Operating Mode
0	0	ISHA Mode
0	1	DAC Mode
1	0	Acquire and Readback
1	1	Readback

1. ISHA Mode

In this mode, a channel is addressed and that channel acquires the voltage on V_{IN} . This mode requires a 10-bit write (see Figure 3) to address the relevant channel ($V_{\text{OUT}0}$ – $V_{\text{OUT}31}$, offset channel or all channels). MSB is written first.

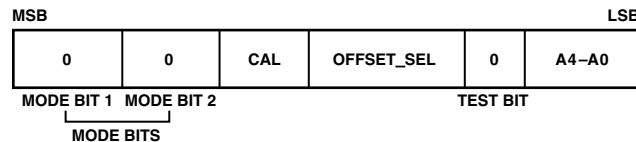

a. 10-Bit Input Serial Write Word (ISHA Mode)



b. 24-Bit Input Serial Write Word (DAC Mode)

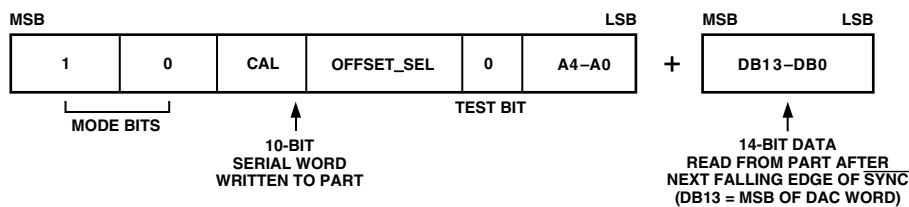

c. Input Serial Interface (Acquire and Readback Mode)

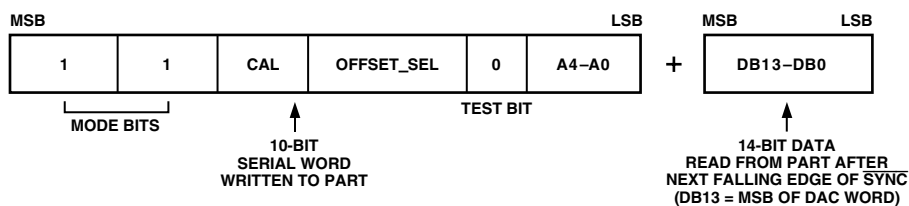

d. Input Serial Interface (Readback Mode)

Figure 10. Serial Interface Formats

2. DAC Mode

In this standard mode, a selected DAC register is loaded serially. This requires a 24-bit write (10 bits to address the relevant DAC plus an extra 14 bits of DAC data). (See Figure 4.) MSB is written first. The user must allow 400 ns (min) between successive writes in DAC mode.

3. Acquire and Readback Mode

This mode allows the user to acquire V_{IN} and read back the data in a particular DAC register. The relevant channel is addressed (10-bit write, MSB first) and V_{IN} is acquired in 16 μ s (max). Following the acquisition, after the next falling edge of \overline{SYNC} , the data in the relevant DAC register is clocked out onto the D_{OUT} line in a 14-bit serial format. (See Figure 5.) The full acquisition time must elapse before the DAC register data can be clocked out.

4. Readback Mode

Again, this is a readback mode but no acquisition is performed. The relevant channel is addressed (10-bit write, MSB first) and on the next falling edge of \overline{SYNC} , the data in the relevant DAC register is clocked out onto the D_{OUT} line in a 14-bit serial format. (See Figure 5.) The user must allow 400 ns (min) between the last SCLK falling edge in the 10-bit write and the falling edge of \overline{SYNC} in the 14-bit readback. The serial write and read words can be seen in Figure 10.

This feature allows the user to read back the DAC register code of any of the channels. In DAC mode, this is useful in verification of write cycles. In ISHA mode, readback is useful if the system has been calibrated and the user wants to know what code in the DAC corresponds to a desired voltage on V_{OUT} . If the user requires this voltage again, the user can input the code directly to the DAC register without going through the acquisition sequence.

INTERFACES

SERIAL INTERFACE

The $\overline{SER}/\overline{PAR}$ pin is tied high to enable the serial interface and to disable the parallel interface. The serial interface is controlled by four pins as follows:

\overline{SYNC} , D_{IN} , SCLK

Standard 3-wire interface pins. The \overline{SYNC} pin is shared with the CS function of the parallel interface.

D_{OUT}

Data out pin for reading back the contents of the DAC registers. The data is clocked out on the rising edge of SCLK and is valid on the falling edge of SCLK.

Mode Bits

There are four different modes of operation as described above.

Cal Bit

In DAC mode, this is a test bit. When it is high it is used to load all zeros or all ones to the 32 DACs simultaneously. In ISHA mode, all 32 channels acquire V_{IN} simultaneously when this bit is high. In ISHA mode, the acquisition time is then 45 μ s (typ) and accuracy may be reduced. This bit is set low for normal operation.

Offset_Sel Bit

If this is set high, the offset channel is selected and Bits A4–A0 are ignored.

Test Bit

This must be set low for correct operation of the part.

A4–A0 Bits

Used to address any one of the 32 channels (A4 = MSB of address, A0 = LSB).

DB13–DB0 Bits

These are used to write a 14-bit word into the addressed DAC register. Clearly, this is only valid when in DAC mode.

The serial interface is designed to allow easy interfacing to most microcontrollers and DSPs, e.g., PIC16C, PIC17C, QSPI™, SPT™, DSP56000, TMS320, and ADSP-21xx, without the need for any glue logic. When interfacing to the 8051, the SCLK must be inverted. The Microprocessor/Microcontroller Interface section explains how to interface to some popular DSPs and microcontrollers.

Figures 3, 4, and 5 show the timing diagram for a serial read and write to the AD5532B. The serial interface works with both a continuous and a noncontinuous serial clock. The first falling edge of \overline{SYNC} resets a counter that counts the number of serial clocks to ensure the correct number of bits are shifted in and out of the serial shift registers. Any further edges on \overline{SYNC} are ignored until the correct number of bits are shifted in or out. Once the correct number of bits for the selected mode have been shifted in or out, the SCLK is ignored. In order for another serial transfer to take place, the counter must be reset by the falling edge of \overline{SYNC} .

In readback, the first rising SCLK edge after the falling edge of \overline{SYNC} causes D_{OUT} to leave its high impedance state and data is clocked out onto the D_{OUT} line and also on subsequent SCLK rising edges. The D_{OUT} pin goes back into a high impedance state on the falling edge of the fourteenth SCLK. Data on the D_{IN} line is latched in on the first SCLK falling edge after the falling edge of the \overline{SYNC} signal and on subsequent SCLK falling edges. During readback D_{IN} is ignored. The serial interface will not shift data in or out until it receives the falling edge of the \overline{SYNC} signal.

PARALLEL INTERFACE (ISHA Mode Only)

The $\overline{SER}/\overline{PAR}$ bit must be tied low to enable the parallel interface and disable the serial interface. The parallel interface is controlled by nine pins.

\overline{CS}

Active low package select pin. This pin is shared with the \overline{SYNC} function for the serial interface.

\overline{WR}

Active low write pin. The values on the address pins are latched on a rising edge of \overline{WR} .

A4–A0

Five address pins (A4 = MSB of address, A0 = LSB). These are used to address the relevant channel (out of a possible 32).

Offset_Sel

Offset select pin. This has the same function as the Offset_Sel bit in the serial interface. When it is high, the offset channel is addressed. The address on A4–A0 is ignored in this case.

Cal

When this pin is high, all 32 channels acquire V_{IN} simultaneously. The acquisition time is then 45 μ s (typ) and accuracy may be reduced.

*SPI and QSPI are trademarks of Motorola, Inc.

AD5532B

MICROPROCESSOR INTERFACING

AD5532B to ADSP-21xx Interface

The ADSP-21xx family of DSPs is easily interfaced to the AD5532B without the need for extra logic.

A data transfer is initiated by writing a word to the TX register after the SPORT has been enabled. In a write sequence, data is clocked out on each rising edge of the DSP's serial clock and clocked into the AD5532B on the falling edge of its SCLK. In readback, 16 bits of data are clocked out of the AD5532B on each rising edge of SCLK and clocked into the DSP on the rising edge of SCLK. D_{IN} is ignored. The valid 14 bits of data will be centered in the 16-bit RX register when using this configuration. The SPORT control register should be set up as follows:

- TFSW = RFSW = 1, Alternate Framing
- INVRFS = INVTFS = 1, Active Low Frame Signal
- DTYPE = 00, Right Justify Data
- ISCLK = 1, Internal Serial Clock
- TFSR = RFSR = 1, Frame Every Word
- IRFS = 0, External Framing Signal
- ITFS = 1, Internal Framing Signal
- SLEN = 1001, 10-Bit Data-Words (ISHA Mode Write)
- SLEN = 0111, 3 8-Bit Data-Words (DAC Mode Write)
- SLEN = 1111, 16-Bit Data-Words (Readback Mode)

Figure 11 shows the connection diagram.

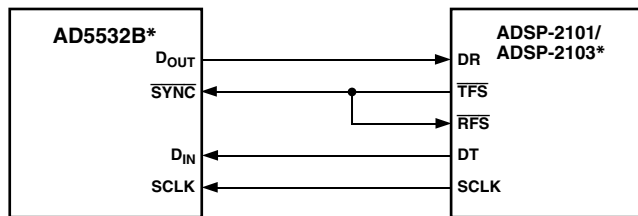

*ADDITIONAL PINS OMITTED FOR CLARITY

Figure 11. AD5532B to ADSP-2101/ADSP-2103 Interface

AD5532B to MC68HC11

The serial peripheral interface (SPI) on the MC68HC11 is configured for master mode (MSTR = 1), clock polarity bit (CPOL) = 0, and the clock phase bit (CPHA) = 1. The SPI is configured by writing to the SPI control register (SPCR)—see *68HC11 User Manual*. SCK of the 68HC11 drives the SCLK of the AD5532B, the MOSI output drives the serial data line (D_{IN}) of the AD5532B, and the MISO input is driven from D_{OUT} . The SYNC signal is derived from a port line (PC7). A connection diagram is shown in Figure 12.

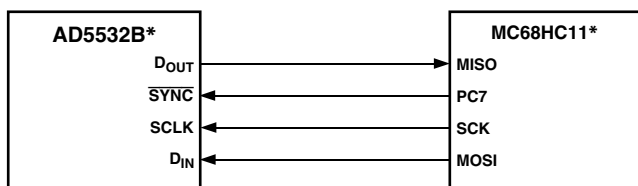

*ADDITIONAL PINS OMITTED FOR CLARITY

Figure 12. AD5532B to MC68HC11 Interface

When data is being transmitted to the AD5532B, the SYNC line is taken low (PC7). Data appearing on the MOSI output is valid on the falling edge of SCK. Serial data from the 68HC11 is transmitted in 8-bit bytes with only eight falling clock edges occurring in the transmit cycle. Data is transmitted MSB first. In order to transmit 10 data bits in ISHA mode, it is important to left-justify the data in the SPDR register. PC7 must be pulled low to start a transfer. It is taken high and pulled low again before any further read/write cycles can take place.

AD5532B to PIC16C6x/7x

The PIC16C6x/7x synchronous serial port (SSP) is configured as an SPI master with the clock polarity bit = 0. This is done by writing to the synchronous serial port control register (SSPCON). See *PIC16/17 Microcontroller User Manual*. In this example, I/O port RA1 is being used to pulse $\overline{\text{SYNC}}$ and enable the serial port of the AD5532B. This microcontroller transfers only eight bits of data during each serial transfer operation; therefore, two or three consecutive read/write operations are needed depending on the mode. Figure 13 shows the connection diagram.

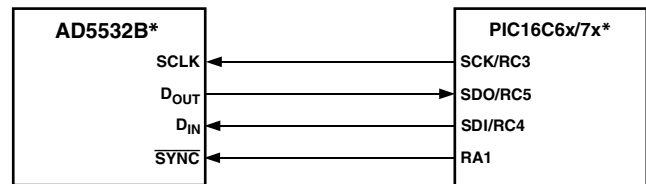

*ADDITIONAL PINS OMITTED FOR CLARITY

Figure 13. AD5532B to PIC16C6x/7x Interface

AD5532B to 8051

The AD5532B requires a clock synchronized to the serial data. The 8051 serial interface must therefore be operated in Mode 0. In this mode, serial data enters and exits through RxD and a shift clock is output on TxD. Figure 14 shows how the 8051 is connected to the AD5532B. Because the AD5532B shifts data out on the rising edge of the shift clock and latches data in on the falling edge, the shift clock must be inverted. The AD5532B requires its data with the MSB first. Since the 8051 outputs the LSB first, the transmit routine must take this into account.

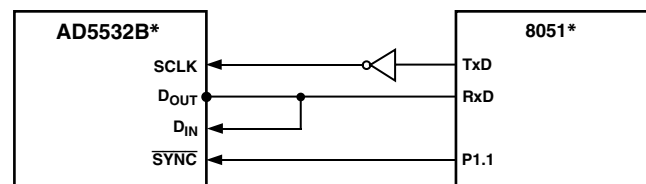

*ADDITIONAL PINS OMITTED FOR CLARITY

Figure 14. AD5532B to 8051 Interface

APPLICATION CIRCUITS

AD5532B in a Typical ATE System

The AD5532B is ideally suited for use in automatic test equipment. Several DACs are required to control pin drivers, comparators, active loads, and signal timing. Traditionally, sample-and-hold devices were used in these applications.

The AD5532B has several advantages: no refreshing is required, there is no droop, pedestal error is eliminated, and there is no need for extra filtering to remove glitches. Overall a higher level of integration is achieved in a smaller area (see Figure 15).

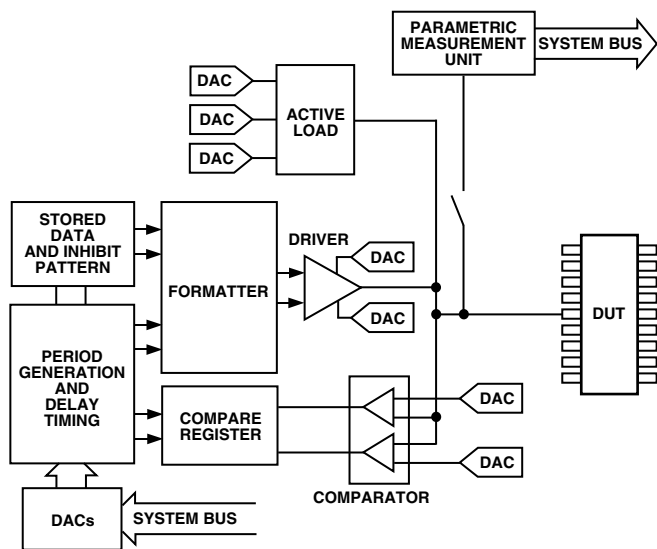

Figure 15. AD5532B in an ATE System

Typical Application Circuit (DAC Mode)

The AD5532B can be used in many optical networking applications that require a large number of DACs to perform control and measurement functions. In the example shown in Figure 16, the outputs of the AD5532B are amplified and used to control actuators that determine the position of MEMS mirrors in an optical switch. The exact position of each mirror is measured using sensors. The sensor readings are muxed using four dual 4-channel matrix switches (ADG739) and fed back to an 8-channel 14-bit ADC (AD7856).

The control loop is driven by an ADSP-2191M, a 16-bit fixed-point DSP with three SPORT interfaces and two SPI ports. The DSP uses some of these serial ports to write data to the DAC, control the multiplexer, and read back data from the ADC.

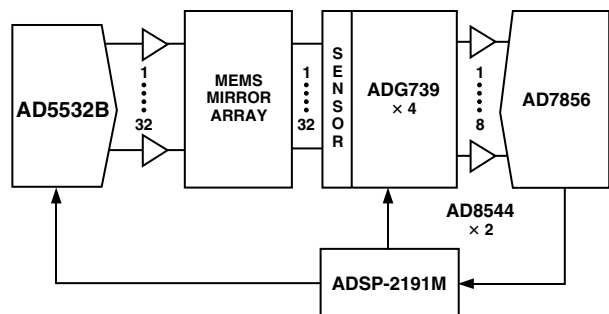

Figure 16. Typical Optical Control and Measurement Application Circuit

Typical Application Circuit (ISHA Mode)

The AD5532B can be used to set up voltage levels on 32 channels as shown in the circuit below. An AD780 provides the 3 V reference for the AD5532B, and for the AD5541 16-bit DAC. A simple 3-wire serial interface is used to write to the AD5541. Because the AD5541 has an output resistance of 6.25 k Ω (typ), the time taken to charge/discharge the capacitance at the V_{IN} pin is significant. Thus an AD820 is used to buffer the DAC output. Note that it is important to minimize noise on V_{IN} and REF_{IN} when laying out this circuit.

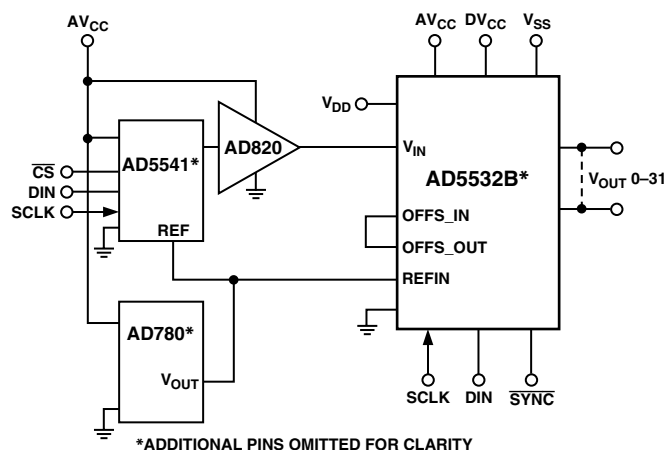

Figure 17. Typical Application Circuit (ISHA Mode)

POWER SUPPLY DECOUPLING

In any circuit where accuracy is important, careful consideration of the power supply and ground return layout helps to ensure the rated performance. The printed circuit board on which the AD5532B is mounted should be designed so that the analog and digital sections are separated, and confined to certain areas of the board. If the AD5532B is in a system where multiple devices require an AGND-to-DGND connection, the connection should be made at one point only. The star ground point should be established as close as possible to the device. For supplies with multiple pins (V_{SS} , V_{DD} , AV_{CC}), it is recommended to tie those pins together. The AD5532B should have ample supply bypassing of 10 μF in parallel with 0.1 μF on each supply located as close to the package as possible, ideally right up against the device. The 10 μF capacitors are the tantalum bead type. The 0.1 μF capacitor should have low effective series resistance (ESR) and effective series inductance (ESI), like the common ceramic types that provide a low impedance path to ground at high frequencies, to handle transient currents due to internal logic switching.

AD5532B

The power supply lines of the AD5532B should use as large a trace as possible to provide low impedance paths and reduce the effects of glitches on the power supply line. Fast switching signals such as clocks should be shielded with digital ground to avoid radiating noise to other parts of the board, and should never be run near the reference inputs. A ground line routed between the D_{IN} and $SCLK$ lines will help reduce crosstalk between them (not required on a multilayer board as there will be a separate ground plane, but separating the lines will help).

Note that it is essential to minimize noise on V_{IN} and $REFIN$ lines. Particularly for optimum ISHA performance, the V_{IN} line must be kept noise-free. Depending on the noise performance of the board, a noise filtering capacitor may be required on the V_{IN}

line. If this capacitor is necessary, then for optimum throughput it may be necessary to buffer the source that is driving V_{IN} .

Avoid crossover of digital and analog signals. Traces on opposite sides of the board should run at right angles to each other. This reduces the effects of feedthrough through the board. A microstrip technique is by far the best, but not always possible with a double-sided board. In this technique, the component side of the board is dedicated to ground plane while signal traces are placed on the solder side.

As is the case for all thin packages, care must be taken to avoid flexing the package and to avoid a point load on the surface of the package during the assembly process.

C02709-0-9/02(A)

OUTLINE DIMENSIONS

74-Lead Chip Scale Ball Grid Array [CSPBGA] (BC-74)

Dimensions shown in millimeters

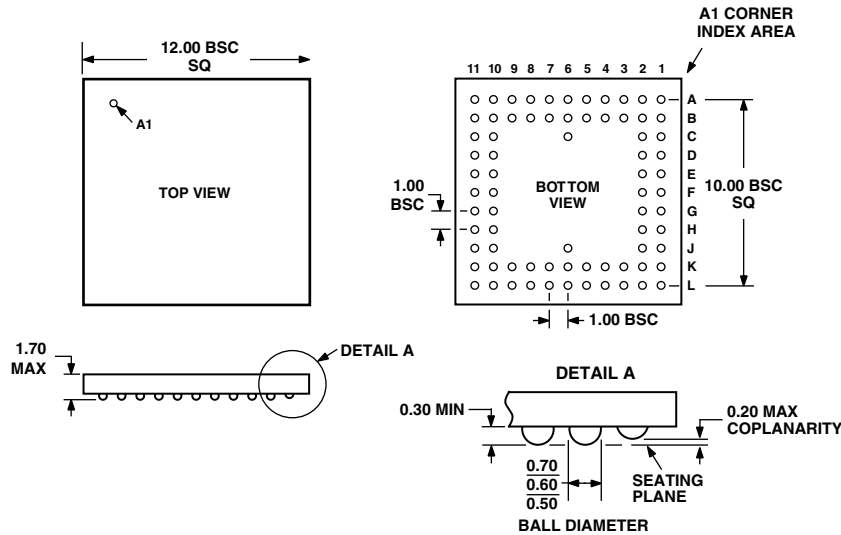

COMPLIANT TO JEDEC STANDARDS MO-192ABD-1

Revision History

Location	Page
9/02—Data Sheet changed from REV. 0 to REV. A.	
Term LFBGA updated to CSPBGA	Global
Changes to SERIAL INTERFACE table	4
Replaced Figure 5	5
Changes to ABSOLUTE MAXIMUM RATINGS	6
Changes to Figure 8	11
Updated BC-74 package drawing	16

PRINTED IN U.S.A.

This datasheet has been download from:

www.datasheetcatalog.com

Datasheets for electronics components.