

# NCS2551

## 500 MHz Voltage Feedback Op Amp

NCS2551 is a 500 MHz voltage feedback monolithic operational amplifier featuring high slew rate and low differential gain and phase error. The voltage feedback architecture allows for a superior bandwidth and low power consumption.

### Features

- -3.0 dB Small Signal BW ( $A_V = +2.0$ ,  $V_O = 0.5 V_{p-p}$ ) 500 MHz Typ
- Slew Rate 1400 V/ $\mu$ s
- Supply Current 5.5 mA
- Input Referred Voltage Noise 6.0 nV/ $\sqrt{\text{Hz}}$
- THD -62 dBc ( $f = 5.0$  MHz,  $V_O = 2.0 V_{p-p}$ )
- Output Current 100 mA
- Pin Compatible with AD8055, TSH341
- This is a Pb-Free Device

### Applications

- Line Drivers
- Radar/Communication Receivers

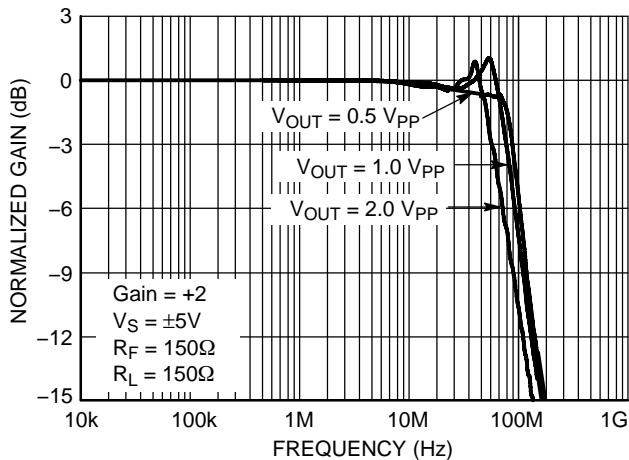

**Figure 1. Frequency Response:**  
Gain (dB) vs. Frequency  $A_V = +2.0$



**ON Semiconductor®**

<http://onsemi.com>



**SOT23-5  
(TSOP-5)  
SN SUFFIX  
CASE 483**

### MARKING DIAGRAM

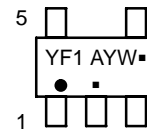

YF1 = Specific Device Code  
A = Assembly Location  
Y = Year  
W = Work Week  
▪ = Pb-Free Package  
(Note: Microdot may be in either location)

### SOT23-5 PINOUT

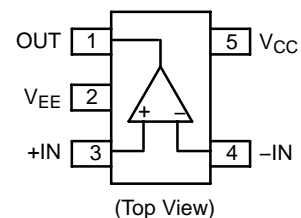

### ORDERING INFORMATION

See detailed ordering and shipping information in the package dimensions section on page 11 of this data sheet.

# NCS2551

## PIN FUNCTION DESCRIPTION

Pin (SOT23-5/SC70)	Symbol	Function	Equivalent Circuit
1	OUT	Output	
2	$V_{EE}$	Negative Power Supply	
3	+IN	Non-inverted Input	
4	-IN	Inverted Input	See Above
5	$V_{CC}$	Positive Power Supply	

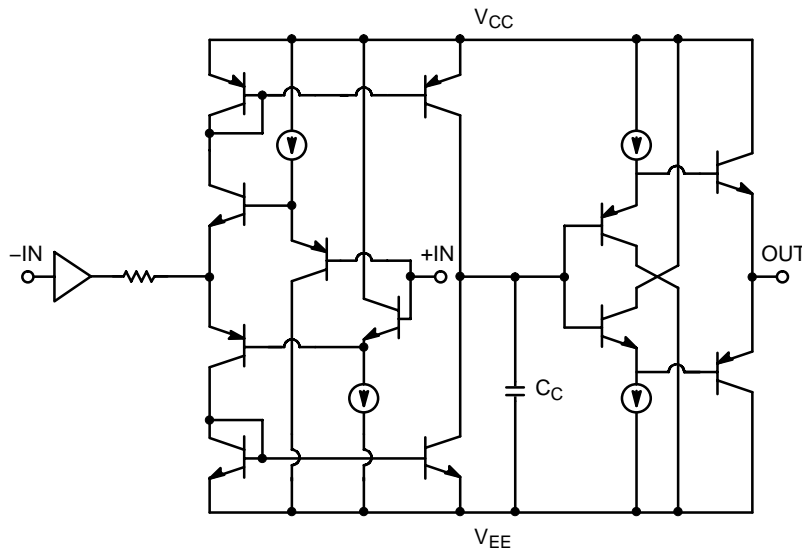

**Figure 2. Simplified Device Schematic**

**ATTRIBUTES**

Characteristics	Value
ESD	
Human Body Model	2.0 kV
Machine Model	200 V
Charged Device Model	1.0 kV
Moisture Sensitivity (Note 1)	Level 1
Flammability Rating    Oxygen Index: 28 to 34	UL 94 V-0 @ 0.125 in

1. For additional information, see Application Note AND8003/D.

**MAXIMUM RATINGS**

Parameter	Symbol	Rating	Unit
Power Supply Voltage	$V_S$	11	Vdc
Input Voltage Range	$V_I$	$\leq V_S$	Vdc
Input Differential Voltage Range	$V_{ID}$	$\leq V_S$	Vdc
Output Current	$I_O$	100	mA
Maximum Junction Temperature (Note 2)	$T_J$	150	°C
Operating Ambient Temperature	$T_A$	-40 to +85	°C
Storage Temperature Range	$T_{stg}$	-60 to +150	°C
Power Dissipation	$P_D$	(See Graph)	mW
Thermal Resistance, Junction-to-Air	$R_{\theta JA}$	158	°C/W

Stresses exceeding Maximum Ratings may damage the device. Maximum Ratings are stress ratings only. Functional operation above the Recommended Operating Conditions is not implied. Extended exposure to stresses above the Recommended Operating Conditions may affect device reliability.

2. Power dissipation must be considered to ensure maximum junction temperature ( $T_J$ ) is not exceeded.

**MAXIMUM POWER DISSIPATION**

The maximum power that can be safely dissipated is limited by the associated rise in junction temperature. For the plastic packages, the maximum safe junction temperature is 150°C. If the maximum is exceeded momentarily, proper circuit operation will be restored as soon as the die temperature is reduced. Leaving the device in the “overheated” condition for an extended period can result in device damage.

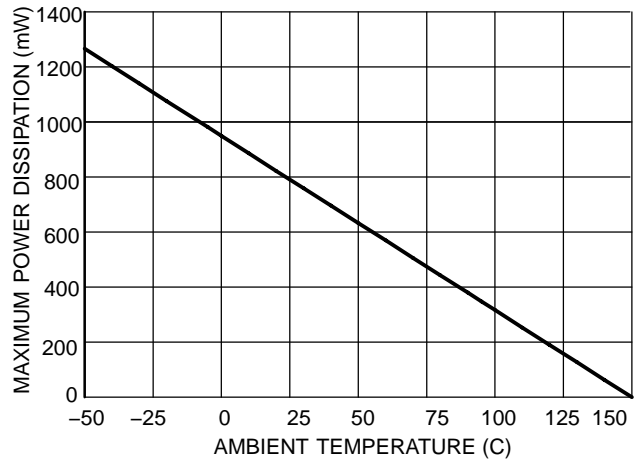

**Figure 3. Power Dissipation vs. Temperature**

# NCS2551

**AC ELECTRICAL CHARACTERISTICS** ( $V_{CC} = +5.0\text{ V}$ ,  $V_{EE} = -5.0\text{ V}$ ,  $T_A = -40^\circ\text{C}$  to  $+85^\circ\text{C}$ ,  $R_L = 150\ \Omega$  to GND,  $R_F = 150\ \Omega$ ,  $A_V = +2.0$ , Enable is left open, unless otherwise specified).

Symbol	Characteristic	Conditions	Min	Typ	Max	Unit
--------	----------------	------------	-----	-----	-----	------

## FREQUENCY DOMAIN PERFORMANCE

BW	Bandwidth 3.0 dB Small Signal 3.0 dB Large Signal	$A_V = +2.0$ , $V_O = 0.5\text{ V}_{p-p}$ $A_V = +2.0$ , $V_O = 2.0\text{ V}_{p-p}$		500 300		MHz
$GF_{0.1dB}$	0.1 dB Gain Flatness Bandwidth	$A_V = +2.0$		15		MHz
dG	Differential Gain	$A_V = +2.0$ , $R_L = 150\ \Omega$ , $f = 3.58\text{ MHz}$		0.06		%
dP	Differential Phase	$A_V = +2.0$ , $R_L = 150\ \Omega$ , $f = 3.58\text{ MHz}$		0.06		°

## TIME DOMAIN RESPONSE

SR	Slew Rate	$A_V = +2.0$ , $V_{step} = 2.0\text{ V}$		1400		V/ $\mu\text{s}$
$t_s$	Settling Time 0.1%	$A_V = +2.0$ , $V_{step} = 2.0\text{ V}$		10		ns
$t_r$ $t_f$	Rise and Fall Time	(10%–90%) $A_V = +2.0$ , $V_{step} = 2.0\text{ V}$		2.4		ns

## HARMONIC/NOISE PERFORMANCE

THD	Total Harmonic Distortion	$f = 5.0\text{ MHz}$ , $V_O = 2.0\text{ V}_{p-p}$		-62		dB
HD2	2nd Harmonic Distortion	$f = 5.0\text{ MHz}$ , $V_O = 2.0\text{ V}_{p-p}$		-68		dBc
HD3	3rd Harmonic Distortion	$f = 5.0\text{ MHz}$ , $V_O = 2.0\text{ V}_{p-p}$		-63		dBc
IP3	Third-Order Intercept	$f = 10\text{ MHz}$ , $V_O = 1.0\text{ V}_{p-p}$		40		dBm
SFDR	Spurious-Free Dynamic Range	$f = 5.0\text{ MHz}$ , $V_O = 2.0\text{ V}_{p-p}$		63		dBc
$e_N$	Input Referred Voltage Noise	$f = 1.0\text{ MHz}$		6.0		nV/ $\sqrt{\text{Hz}}$
$i_N$	Input Referred Current Noise	$f = 1.0\text{ MHz}$		3.0		pA/ $\sqrt{\text{Hz}}$

# NCS2551

**DC ELECTRICAL CHARACTERISTICS** ( $V_{CC} = +5.0\text{ V}$ ,  $V_{EE} = -5.0\text{ V}$ ,  $T_A = -40^\circ\text{C}$  to  $+85^\circ\text{C}$ ,  $R_L = 150\ \Omega$  to GND,  $R_F = 150\ \Omega$ ,  $A_V = +2.0$ , Enable is left open, unless otherwise specified).

Symbol	Characteristic	Conditions	Min	Typ	Max	Unit
--------	----------------	------------	-----	-----	-----	------

## DC PERFORMANCE

$V_{IO}$	Input Offset Voltage		-10	0	+10	mV
$\Delta V_{IO}/\Delta T$	Input Offset Voltage Temperature Coefficient			6.0		$\mu\text{V}/^\circ\text{C}$
$I_{IB}$	Input Bias Current	$V_O = 0\text{ V}$		$\pm 3.2$	$\pm 20$	$\mu\text{A}$
$\Delta I_{IB}/\Delta T$	Input Bias Current Temperature Coefficient	$V_O = 0\text{ V}$		$\pm 40$		$\text{nA}/^\circ\text{C}$

## INPUT CHARACTERISTICS

$V_{CM}$	Input Common Mode Voltage Range (Note 3)		$\pm 3.0$	$\pm 4.0$		V
CMRR	Common Mode Rejection Ratio	(See Graph)	40	50		dB
$R_{IN}$	Input Resistance			4.5		$\text{M}\Omega$
$C_{IN}$	Differential Input Capacitance			1.0		pF

## OUTPUT CHARACTERISTICS

$R_{OUT}$	Output Resistance	Closed Loop Open Loop		0.1 17		$\Omega$
$V_O$	Output Voltage Range		$\pm 3.0$	$\pm 4.0$		V
$I_O$	Output Current		$\pm 50$	$\pm 100$		mA

## POWER SUPPLY

$V_S$	Operating Voltage Supply			10		V
$I_S$	Power Supply Current		2.0	5.5	10	mA
PSRR	Power Supply Rejection Ratio	(See Graph)	40	60		dB

3. Guaranteed by design and/or characterization.

# NCS2551

**AC ELECTRICAL CHARACTERISTICS** ( $V_{CC} = +2.5\text{ V}$ ,  $V_{EE} = -2.5\text{ V}$ ,  $T_A = -40^\circ\text{C}$  to  $+85^\circ\text{C}$ ,  $R_L = 150\ \Omega$  to GND,  $R_F = 150\ \Omega$ ,  $A_V = +2.0$ , Enable is left open, unless otherwise specified).

Symbol	Characteristic	Conditions	Min	Typ	Max	Unit
--------	----------------	------------	-----	-----	-----	------

## FREQUENCY DOMAIN PERFORMANCE

BW	Bandwidth 3.0 dB Small Signal 3.0 dB Large Signal	$A_V = +2.0$ , $V_O = 0.5\text{ V}_{p-p}$ $A_V = +2.0$ , $V_O = 1.0\text{ V}_{p-p}$		400 200		MHz
$GF_{0.1dB}$	0.1 dB Gain Flatness Bandwidth	$A_V = +2.0$		10		MHz
dG	Differential Gain	$A_V = +2.0$ , $R_L = 150\ \Omega$ , $f = 3.58\text{ MHz}$		0.07		%
dP	Differential Phase	$A_V = +2.0$ , $R_L = 150\ \Omega$ , $f = 3.58\text{ MHz}$		0.06		°

## TIME DOMAIN RESPONSE

SR	Slew Rate	$A_V = +2.0$ , $V_{step} = 1.0\text{ V}$		800		V/ $\mu\text{s}$
$t_s$	Settling Time 0.1%	$A_V = +2.0$ , $V_{step} = 1.0\text{ V}$		10		ns
$t_r$ , $t_f$	Rise and Fall Time	(10%–90%) $A_V = +2.0$ , $V_{step} = 1.0\text{ V}$		2.2		ns

## HARMONIC/NOISE PERFORMANCE

THD	Total Harmonic Distortion	$f = 5.0\text{ MHz}$ , $V_O = 1.0\text{ V}_{p-p}$		-59		dB
HD2	2nd Harmonic Distortion	$f = 5.0\text{ MHz}$ , $V_O = 1.0\text{ V}_{p-p}$		-60		dBc
HD3	3rd Harmonic Distortion	$f = 5.0\text{ MHz}$ , $V_O = 1.0\text{ V}_{p-p}$		-67		dBc
IP3	Third-Order Intercept	$f = 10\text{ MHz}$ , $V_O = 0.5\text{ V}_{p-p}$		35		dBm
SFDR	Spurious-Free Dynamic Range	$f = 5.0\text{ MHz}$ , $V_O = 1.0\text{ V}_{p-p}$		60		dBc
$e_N$	Input Referred Voltage Noise	$f = 1.0\text{ MHz}$		6.0		nV/ $\sqrt{\text{Hz}}$
$i_N$	Input Referred Current Noise	$f = 1.0\text{ MHz}$		3.0		pA/ $\sqrt{\text{Hz}}$

# NCS2551

**DC ELECTRICAL CHARACTERISTICS** ( $V_{CC} = +2.5\text{ V}$ ,  $V_{EE} = -2.5\text{ V}$ ,  $T_A = -40^\circ\text{C}$  to  $+85^\circ\text{C}$ ,  $R_L = 150\ \Omega$  to GND,  $R_F = 150\ \Omega$ ,  $A_V = +2.0$ , Enable is left open, unless otherwise specified).

Symbol	Characteristic	Conditions	Min	Typ	Max	Unit
--------	----------------	------------	-----	-----	-----	------

## DC PERFORMANCE

$V_{IO}$	Input Offset Voltage		-10	0	+10	mV
$\Delta V_{IO}/\Delta T$	Input Offset Voltage Temperature Coefficient			6.0		$\mu\text{V}/^\circ\text{C}$
$I_{IB}$	Input Bias Current	$V_O = 0\text{ V}$		$\pm 3.2$	$\pm 20$	$\mu\text{A}$
$\Delta I_{IB}/\Delta T$	Input Bias Current Temperature Coefficient	$V_O = 0\text{ V}$		$\pm 40$		$\text{nA}/^\circ\text{C}$

## INPUT CHARACTERISTICS

$V_{CM}$	Input Common Mode Voltage Range (Note 3)		$\pm 0.9$	$\pm 1.5$		V
CMRR	Common Mode Rejection Ratio	(See Graph)	40	50		dB
$R_{IN}$	Input Resistance			4.5		$\text{M}\Omega$
$C_{IN}$	Differential Input Capacitance			1.0		pF

## OUTPUT CHARACTERISTICS

$R_{OUT}$	Output Resistance	Closed Loop Open Loop		0.1 17		$\Omega$
$V_O$	Output Voltage Range		$\pm 0.9$	$\pm 1.5$		V
$I_O$	Output Current		$\pm 50$	$\pm 100$		mA

## POWER SUPPLY

$V_S$	Operating Voltage Supply			5.0		V
$I_S$	Power Supply Current		2.0	5.2	10	mA
PSRR	Power Supply Rejection Ratio	(See Graph)	40	60		dB

4. Guaranteed by design and/or characterization.

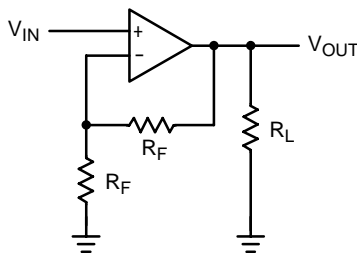

**Figure 4. Typical Test Setup**  
( $A_V = +2.0$ ,  $R_F = 150\ \text{k}\Omega$ ,  $R_L = 150\ \Omega$ )

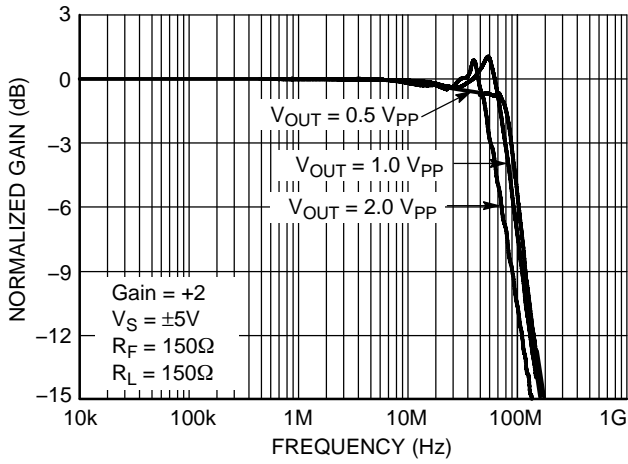

**Figure 5. Frequency Response:**  
Gain (dB) vs. Frequency  
 $A_v = +2.0$

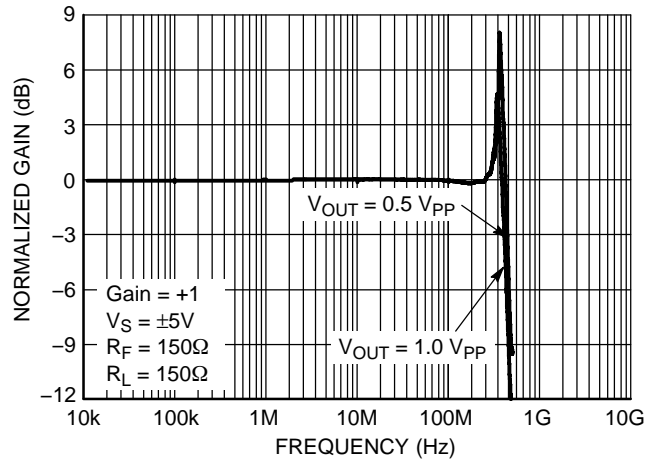

**Figure 6. Frequency Response:**  
Gain (dB) vs. Frequency  
 $A_v = +1.0$

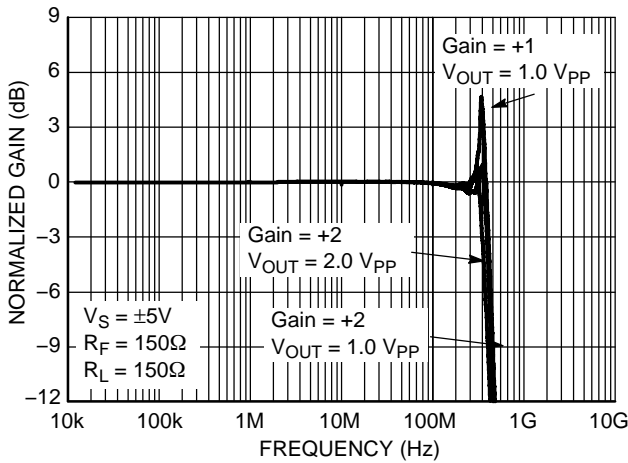

**Figure 7. Large Signal Frequency Response**  
Gain (dB) vs. Frequency

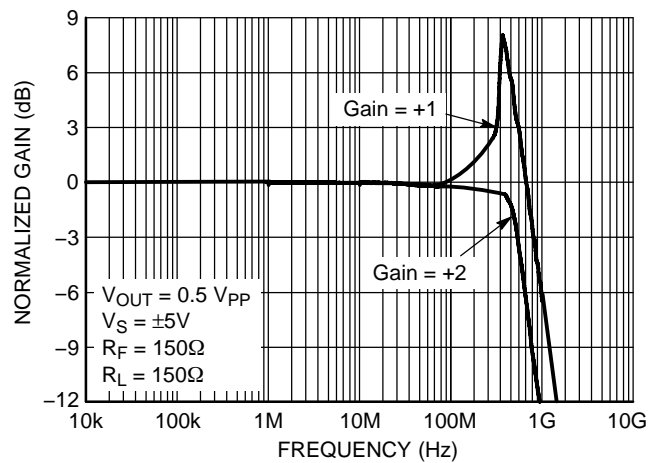

**Figure 8. Small Signal Frequency Response**  
Gain (dB) vs. Frequency

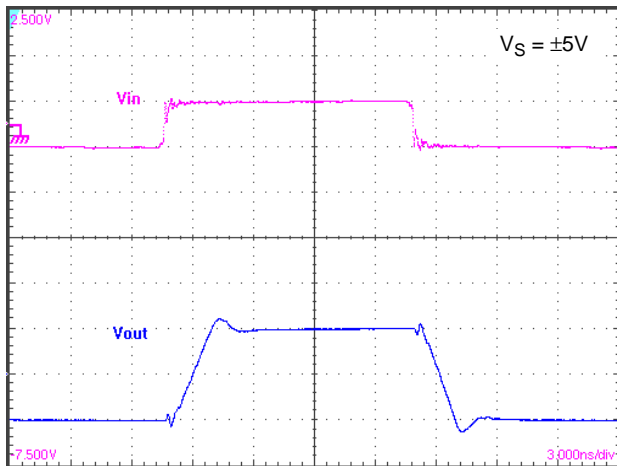

**Figure 9. Small Signal Step Response**  
Vertical: 500 mV/div  
Horizontal: 10 ns/div

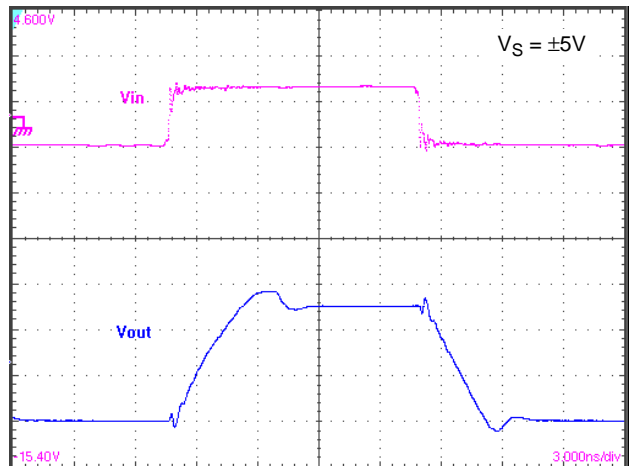

**Figure 10. Large Signal Step Response**  
Vertical: 2V/div  
Horizontal: 10 ns/div



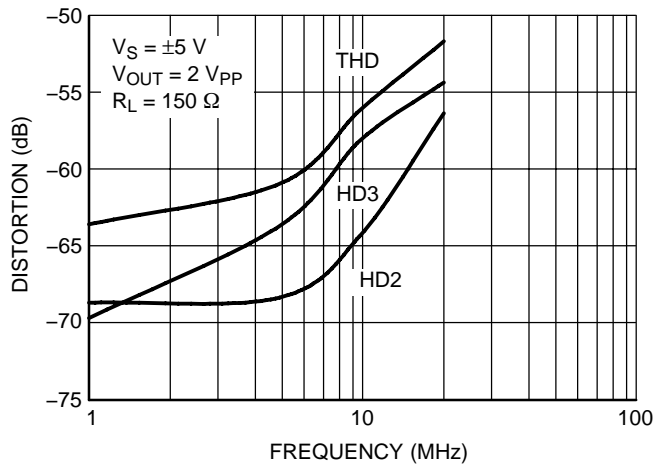

Figure 11. THD, HD2, HD3 vs. Frequency

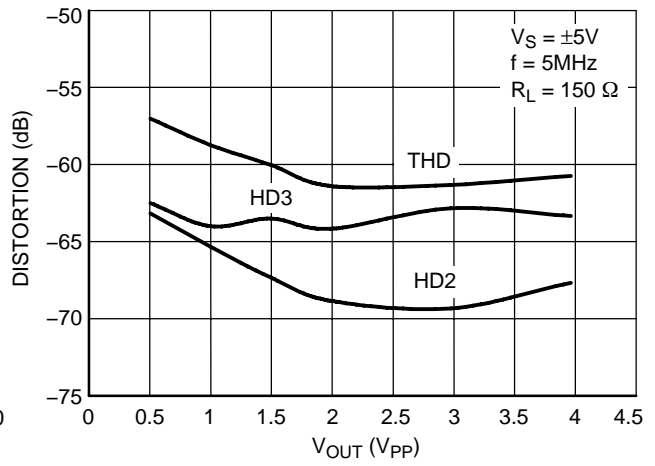

Figure 12. THD, HD2, HD3 vs. Output Voltage

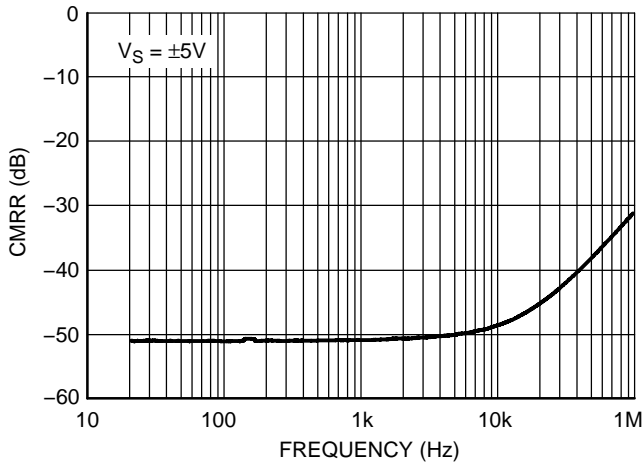

Figure 13. CMRR vs. Frequency

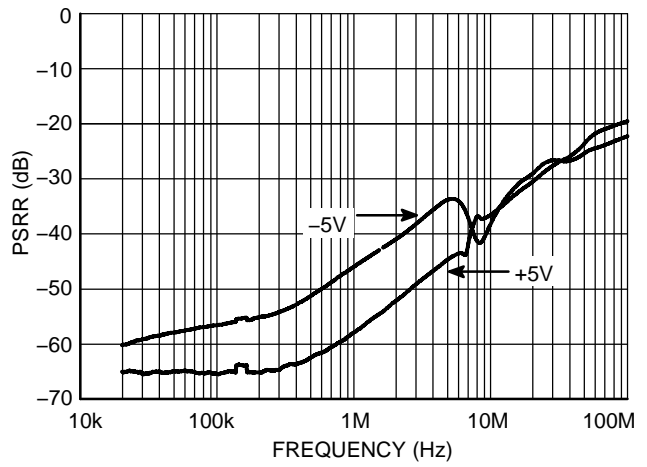

Figure 14. PSRR vs. Frequency

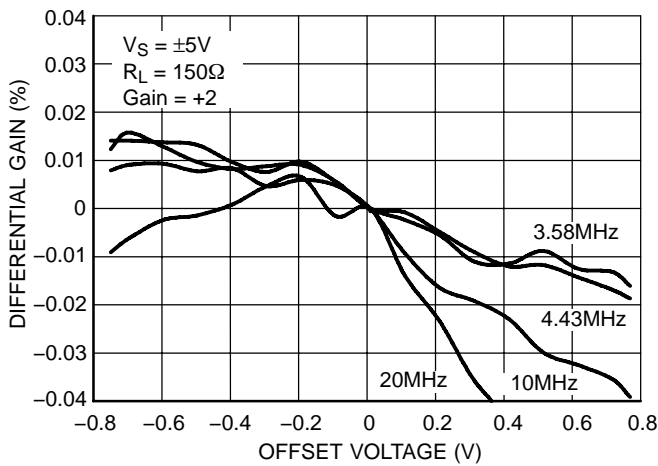

Figure 15. Differential Gain

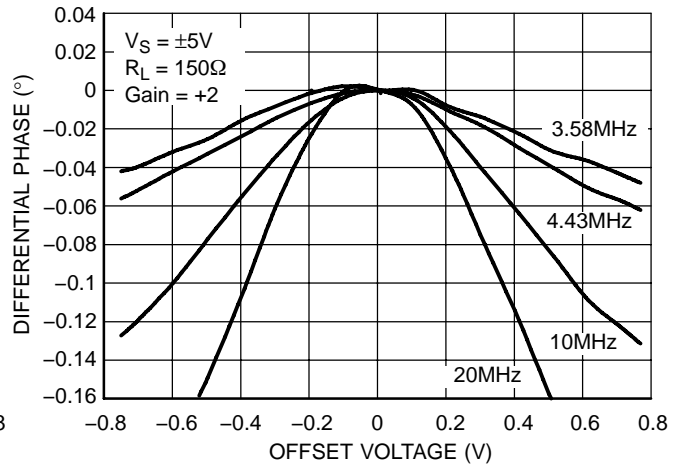

Figure 16. Differential Phase

# NCS2551

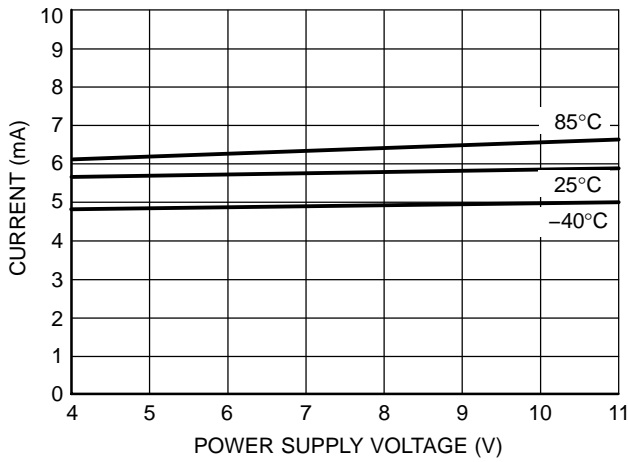

Figure 17. Supply Current vs. Power Supply

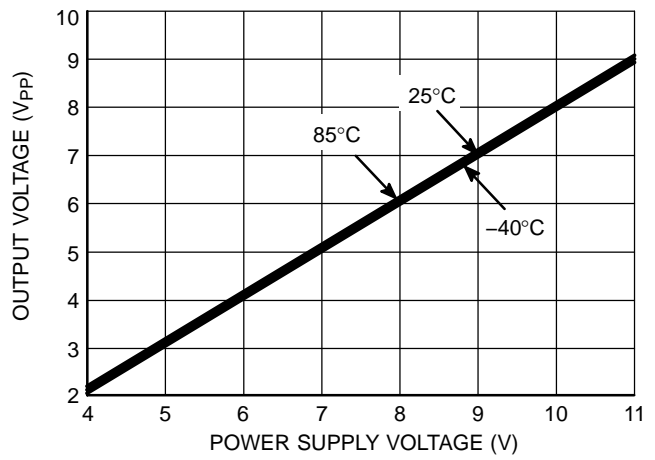

Figure 18. Output Voltage Swing vs. Supply Voltage

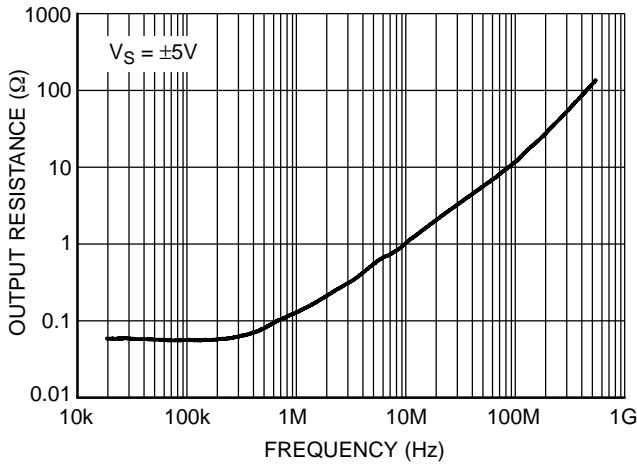

Figure 19. Closed Loop Output Resistance vs. Frequency

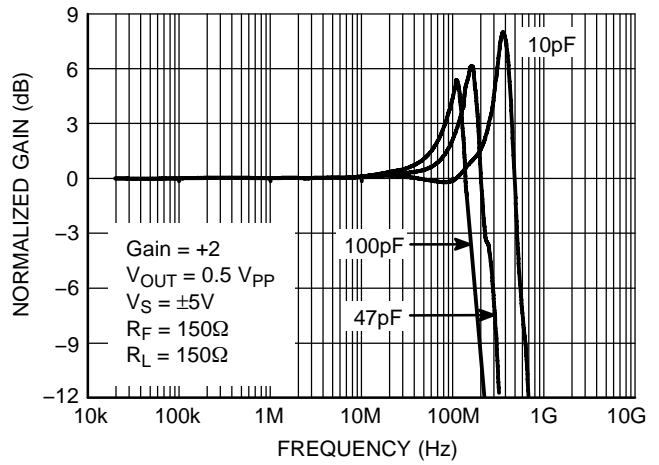

Figure 20. Frequency Response vs. Capacitive Load

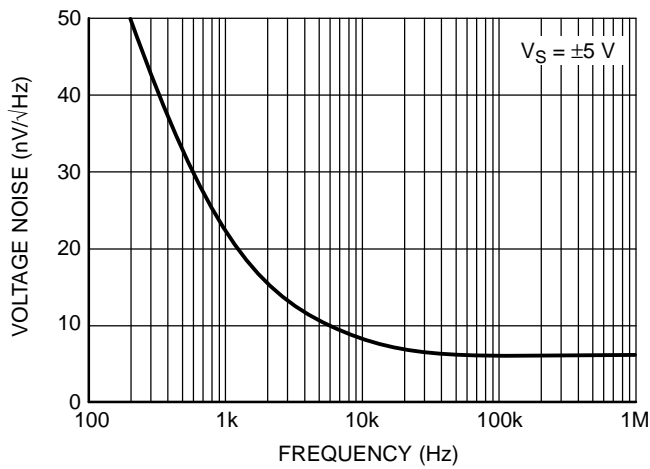

Figure 21. Input Referred Voltage Noise vs. Frequency

**Printed Circuit Board Layout Techniques**

Proper high speed PCB design rules should be used for all wideband amplifiers as the PCB parasitics can affect the overall performance. Most important are stray capacitances at the output and inverting input nodes as it can effect peaking and bandwidth. A space (3/16" is plenty) should be left around the signal lines to minimize coupling. Also, signal lines connecting the feedback and gain resistors should be short enough so that their associated inductance does not cause high frequency gain errors. Line lengths less than 1/4" are recommended.

**Video Performance**

This device designed to provide good performance with NTSC, PAL, and HDTV video signals. Best performance is obtained with back terminated loads as performance is degraded as the load is increased. The back termination reduces reflections from the transmission line and effectively masks transmission line and other parasitic capacitances from the amplifier output stage.

**ESD Protection**

All device pins have limited ESD protection using internal diodes to power supplies as specified in the attributes table (see Figure 22). These diodes provide moderate protection

to input overdrive voltages above the supplies. The ESD diodes can support high input currents with current limiting series resistors. Keep these resistor values as low as possible since high values degrade both noise performance and frequency response. Under closed-loop operation, the ESD diodes have no effect on circuit performance. However, under certain conditions the ESD diodes will be evident. If the device is driven into a slewing condition, the ESD diodes will clamp large differential voltages until the feedback loop restores closed-loop operation. Also, if the device is powered down and a large input signal is applied, the ESD diodes will conduct.

NOTE: Human Body Model for +IN and -IN pins are rated at 0.8kV while all other pins are rated at 2.0kV.

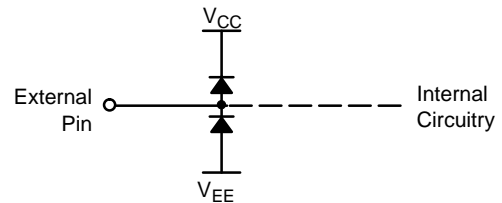

**Figure 22. Internal ESD Protection**

**ORDERING INFORMATION**

Device	Package	Shipping†
NCS2551SNT1G	SOT23-5 (TSOP-5) (Pb-Free)	3000/Tape & Reel

†For information on tape and reel specifications, including part orientation and tape sizes, please refer to our Tape and Reel Packaging Specifications Brochure, BRD8011/D.

# NCS2551

## PACKAGE DIMENSIONS

### TSOP-5 CASE 483-02 ISSUE F

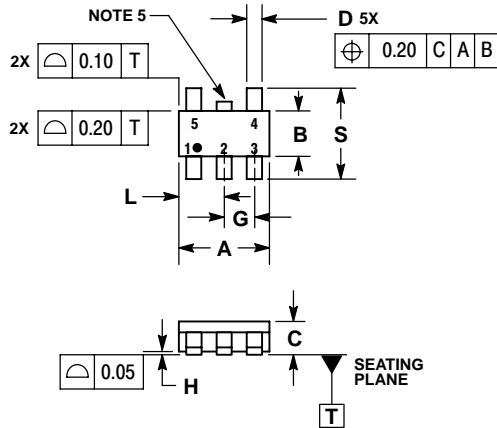

NOTES:

1. DIMENSIONING AND TOLERANCING PER ASME Y14.5M, 1994.
2. CONTROLLING DIMENSION: MILLIMETERS.
3. MAXIMUM LEAD THICKNESS INCLUDES LEAD FINISH THICKNESS. MINIMUM LEAD THICKNESS IS THE MINIMUM THICKNESS OF BASE MATERIAL.
4. DIMENSIONS A AND B DO NOT INCLUDE MOLD FLASH, PROTRUSIONS, OR GATE BURRS.
5. OPTIONAL CONSTRUCTION: AN ADDITIONAL TRIMMED LEAD IS ALLOWED IN THIS LOCATION. TRIMMED LEAD NOT TO EXTEND MORE THAN 0.2 FROM BODY.

DIM	MILLIMETERS	
	MIN	MAX
A	3.00	BSC
B	1.50	BSC
C	0.90	1.10
D	0.25	0.50
G	0.95	BSC
H	0.01	0.10
J	0.10	0.26
K	0.20	0.60
L	1.25	1.55
M	0°	10°
S	2.50	3.00

### SOLDERING FOOTPRINT\*

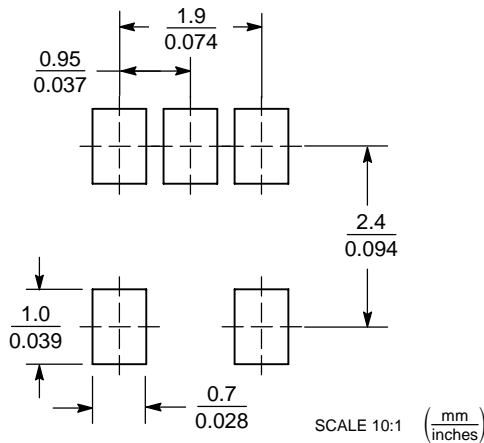

\*For additional information on our Pb-Free strategy and soldering details, please download the ON Semiconductor Soldering and Mounting Techniques Reference Manual, SOLDERRM/D.

ON Semiconductor and are registered trademarks of Semiconductor Components Industries, LLC (SCILLC). SCILLC reserves the right to make changes without further notice to any products herein. SCILLC makes no warranty, representation or guarantee regarding the suitability of its products for any particular purpose, nor does SCILLC assume any liability arising out of the application or use of any product or circuit, and specifically disclaims any and all liability, including without limitation special, consequential or incidental damages. "Typical" parameters which may be provided in SCILLC data sheets and/or specifications can and do vary in different applications and actual performance may vary over time. All operating parameters, including "Typicals" must be validated for each customer application by customer's technical experts. SCILLC does not convey any license under its patent rights nor the rights of others. SCILLC products are not designed, intended, or authorized for use as components in systems intended for surgical implant into the body, or other applications intended to support or sustain life, or for any other application in which the failure of the SCILLC product could create a situation where personal injury or death may occur. Should Buyer purchase or use SCILLC products for any such unintended or unauthorized application, Buyer shall indemnify and hold SCILLC and its officers, employees, subsidiaries, affiliates, and distributors harmless against all claims, costs, damages, and expenses, and reasonable attorney fees arising out of, directly or indirectly, any claim of personal injury or death associated with such unintended or unauthorized use, even if such claim alleges that SCILLC was negligent regarding the design or manufacture of the part. SCILLC is an Equal Opportunity/Affirmative Action Employer. This literature is subject to all applicable copyright laws and is not for resale in any manner.

### PUBLICATION ORDERING INFORMATION

**LITERATURE FULFILLMENT:**  
Literature Distribution Center for ON Semiconductor  
P.O. Box 5163, Denver, Colorado 80217 USA  
**Phone:** 303-675-2175 or 800-344-3860 Toll Free USA/Canada  
**Fax:** 303-675-2176 or 800-344-3867 Toll Free USA/Canada  
**Email:** orderlit@onsemi.com

**N. American Technical Support:** 800-282-9855 Toll Free  
USA/Canada  
**Europe, Middle East and Africa Technical Support:**  
Phone: 421 33 790 2910  
**Japan Customer Focus Center**  
Phone: 81-3-5773-3850

**ON Semiconductor Website:** [www.onsemi.com](http://www.onsemi.com)  
**Order Literature:** <http://www.onsemi.com/orderlit>

For additional information, please contact your local Sales Representative