



Product Description

Sirenza Microdevices' SBB-2089 is a high performance InGaP HBT MMIC amplifier utilizing a Darlington configuration with an active bias network. The active bias network provides stable current over temperature and process Beta variations. Designed to run directly from a 5V supply, the SBB-2089 does not require a dropping resistor as compared to typical Darlington amplifiers. The SBB-2089 product is designed for high linearity 5V gain block applications that require small size and minimal external components. It is internally matched to 50 ohms.

The matte tin finish on Sirenza's lead-free package utilizes a post annealing process to mitigate tin whisker formation and is RoHS compliant per EU Directive 2002/95. This package is also manufactured with green molding compounds that contain no antimony trioxide nor halogenated fire retardants.

Gain & Return Loss vs. Frequency (w/ App. Ckt.)

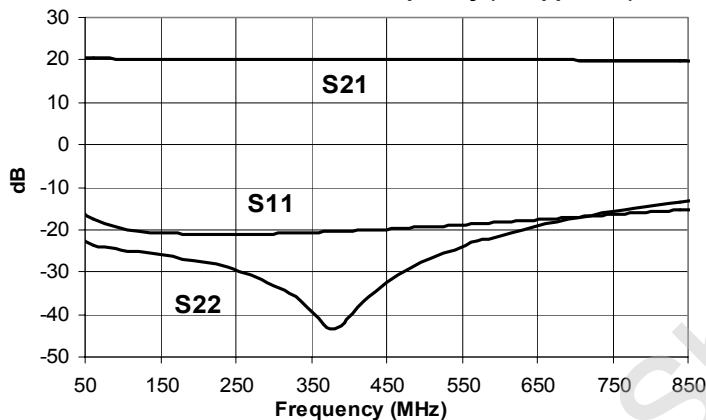

SBB-2089

SBB-2089Z



**50 - 850 MHz, Cascadable
Active Bias InGaP/GaAs HBT MMIC Amplifier**

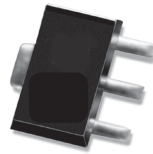

Product Features

- Available in Lead Free, RoHS compliant, & Green packaging
- IP3 = 42.8 dBm @ 240MHz
- P1dB = 20.8 dBm @ 500MHz
- Single Fixed 5V Supply
- Robust 1000V ESD, Class 1C
- Patented Thermal Design & Patent Pending Bias Circuit
- Low Thermal Resistance
- MSL 1 moisture rating

Applications

- Receiver IF Amplifier
- Cellular, PCS, GSM, UMTS
- Wireless Data, Satellite Terminals

Symbol	Parameters	Units	Frequency	Min.	Typ.	Max.
S ₂₁	Small Signal Gain	dB	70 MHz 240 MHz 400 MHz	18.5	20	21.5
P _{1dB}	Output Power at 1dB Compression	dBm	70 MHz 240 MHz 400 MHz	18.5	20 21	
IP ₃	Third Order Intercept Point	dBm	70 MHz 240 MHz 400 MHz	39	41 43 41	
Bandwidth	S ₁₁ , S ₂₂ : Minimum 10dB Return Loss (typ.)	MHz			50 - 850	
IRL	Input Return Loss	dB	70 -500MHz	15	20	
ORL	Output Return Loss	dB	70 -500MHz	11	14	
S ₁₂	Reverse Isolation	dB	70 -500MHz		22	
NF	Noise Figure	dB	500 MHz		2.7	3.7
V _D	Device Operating Voltage	V			5	5.3
I _D	Device Operating Current	mA		82	90	98
R _{TH, j-l}	Thermal Resistance (junction - lead)	°C/W			48.8	

Test Conditions: V_D = 5V I_D = 90mA Typ. OIP₃ Tone Spacing = 1MHz, Pout per tone = 0 dBm
T_L = 25°C Z_S = Z_L = 50 Ohms Tested with Bias Tees

The information provided herein is believed to be reliable at press time. Sirenza Microdevices assumes no responsibility for inaccuracies or omissions. Sirenza Microdevices assumes no responsibility for the use of this information, and all such information shall be entirely at the user's own risk. Prices and specifications are subject to change without notice. No patent rights or licenses to any of the circuits described herein are implied or granted to any third party. Sirenza Microdevices does not authorize or warrant any Sirenza Microdevices product for use in life-support devices and/or systems. Copyright 2001 Sirenza Microdevices, Inc.. All worldwide rights reserved.

Typical RF Performance at Key Operating Frequencies (With Application Circuit)

Symbol	Parameter	Unit	Frequency (MHz)						
			50	70	100	240	400	500	850
S ₂₁	Small Signal Gain	dB	20	20	20	20	20	20	20
OIP ₃	Output Third Order Intercept Point	dBm	40	40	41	42	41	40	35
P _{1dB}	Output Power at 1dB Compression	dBm	20	20	20	20	20	20	19
IRL	Input Return Loss	dB	15	18	19	20	20	19	16
ORL	Output Return Loss	dB	21	23	24	27	34	30	14
S ₁₂	Reverse Isolation	dB	22	22	22	22	22	22	22
NF	Noise Figure	dB	3.1	2.9	2.7	2.6	2.7	2.8	2.9

Test Conditions: VCC = 5V I₀ = 90mA Typ. OIP₃ Tone Spacing = 1MHz, P_{out} per tone = 0 dBm
T_L = 25°C Z_s = Z_L = 50 Ohms

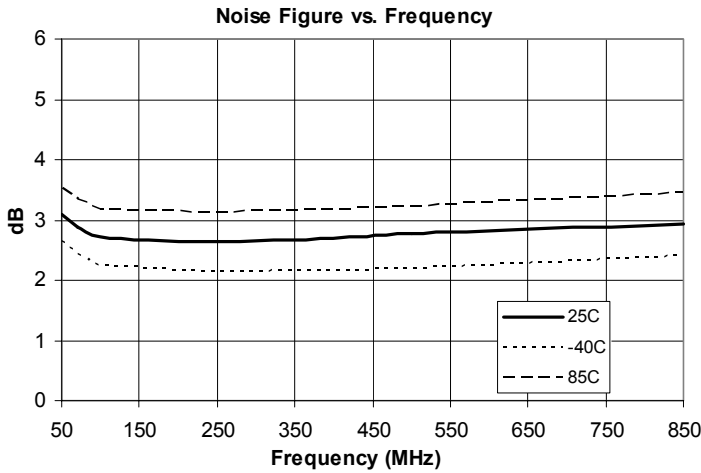

Data on Charts taken with App. Ckt.

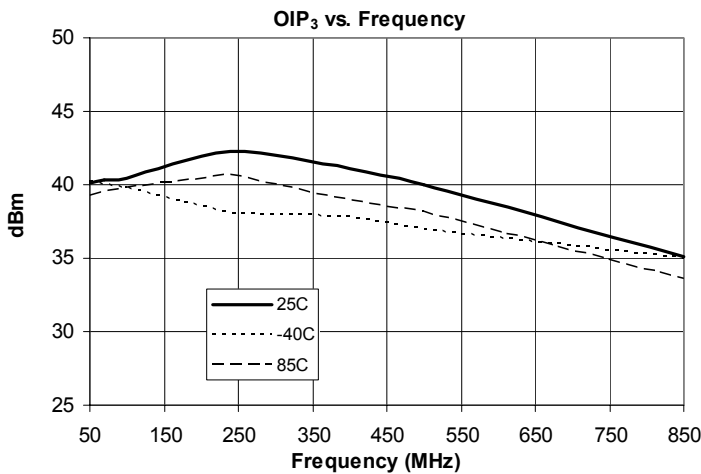
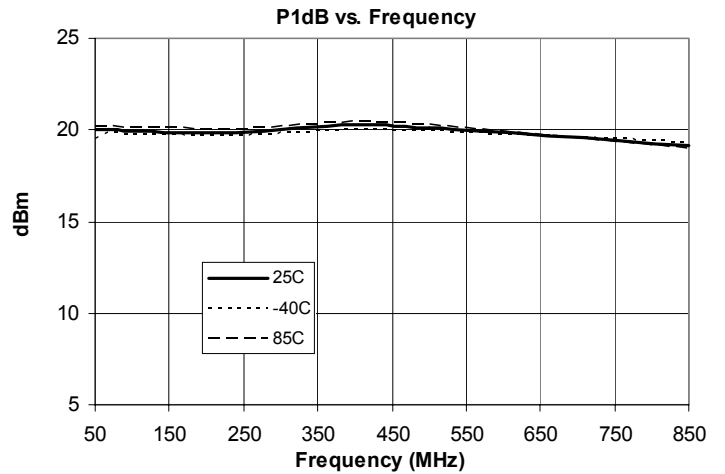

S-Parameters taken with Bias Tee over Temperature

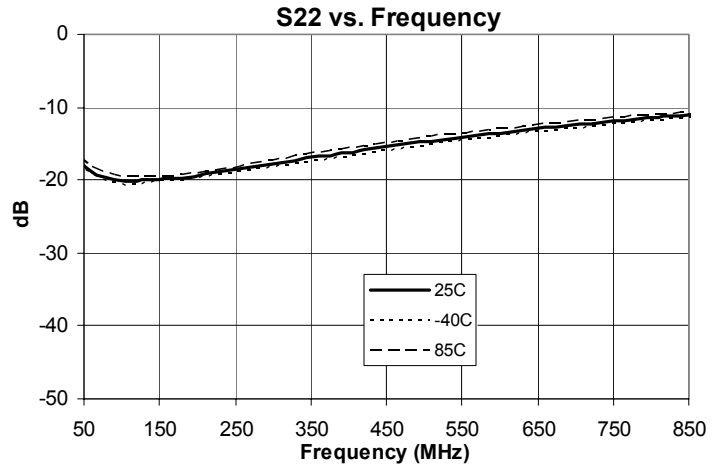
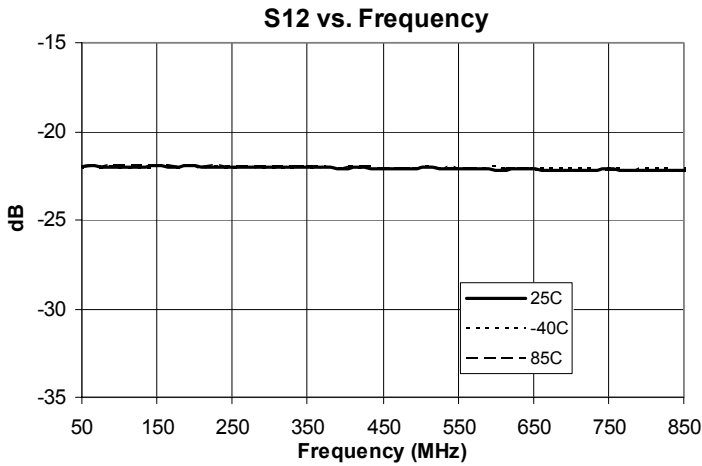
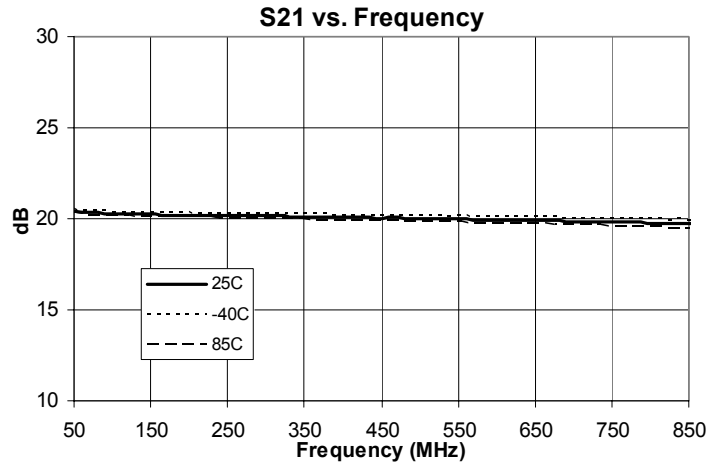
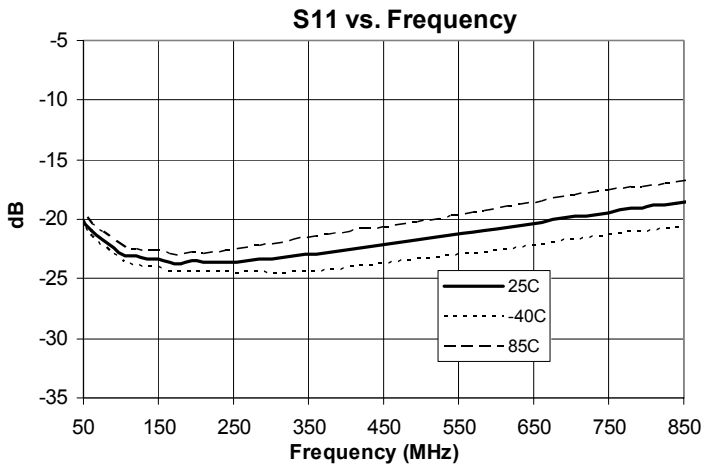

Device Current over Temperature (w/Bias Tee)

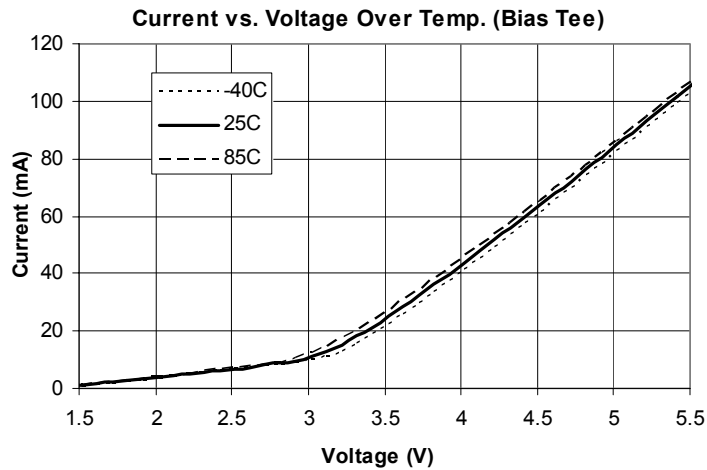

Application Circuit S-Parameters over Temperature

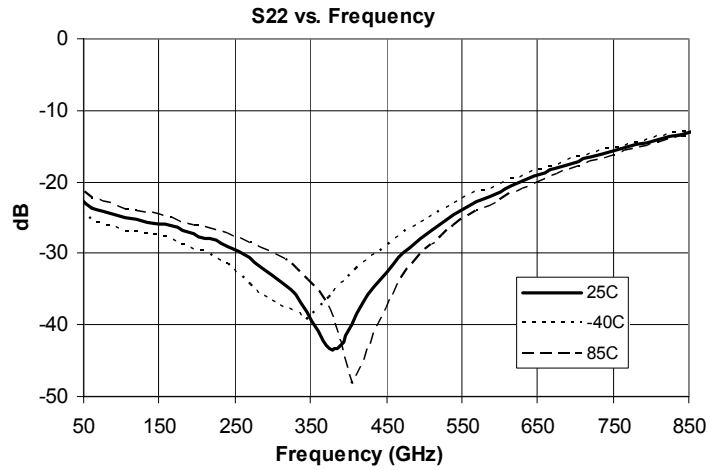
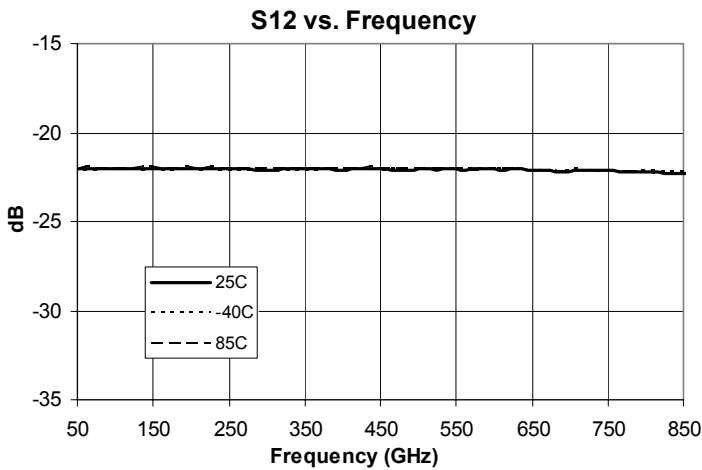
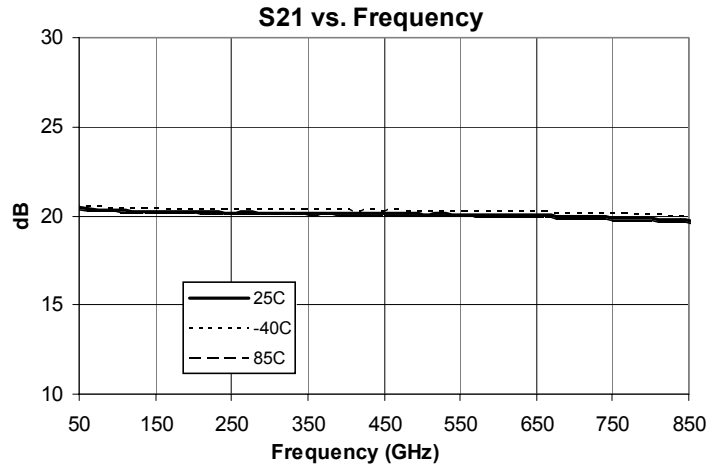
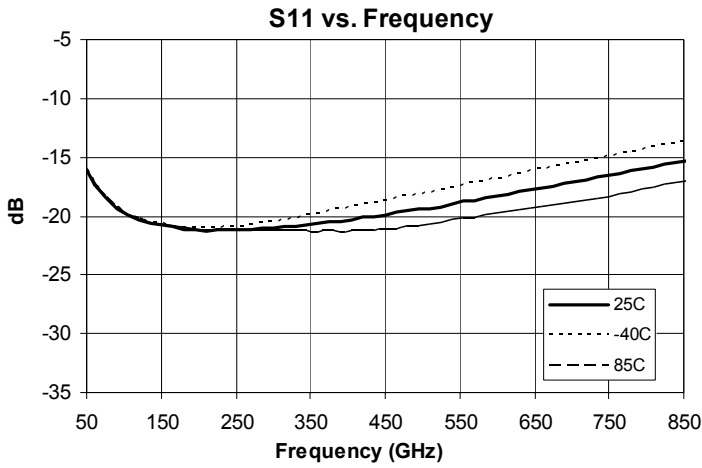

Device Current over Temperature (w/App. Ckt.)

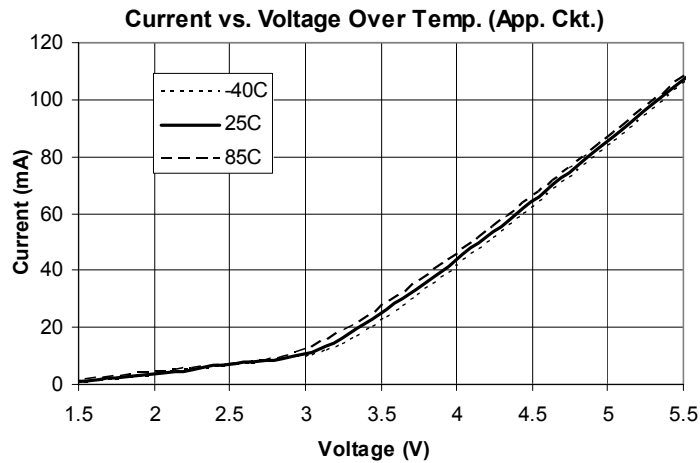

Application Schematic

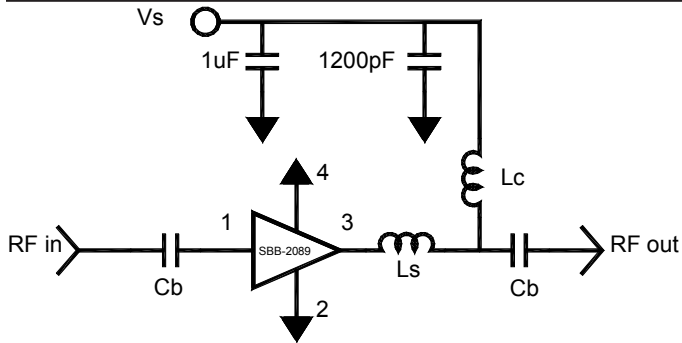

Application Circuit Element Values

Reference Designator	Frequency (MHz) 50 to 850
C _B	8200pF
L _C	1200nH LS Coilcraft
L _S	2.7nH Toko

Evaluation Board Layout

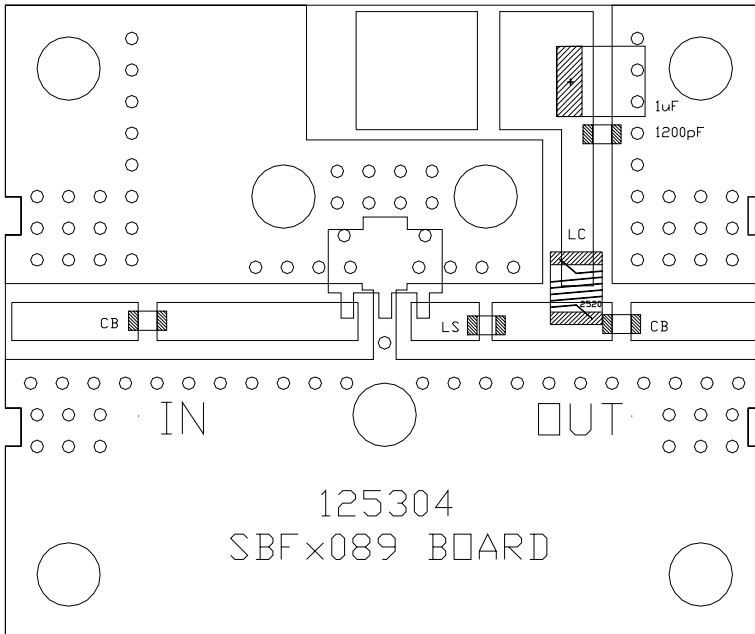

Absolute Maximum Ratings

Parameter	Absolute Limit
Ma. Dvice Current (I _D)	110 mA
Max Device Voltage (V _D)	5.5 V
Max. RF Input Power	+12 dBm
Max. Operating Dissipated Power	0.61 W
Max. Junction Temp. (T _J)	+150°C
Operating Temp. Range (T _L)	-40°C to +85°C
Max. Storage Temp.	+150°C

Operation of this device beyond any one of these limits may cause permanent damage. For reliable continuous operation, the device voltage and current must not exceed the maximum operating values specified in the table on page one.
 Bias Conditions should also satisfy the following expression:
 $I_D V_D < (T_J - T_L) / R_{TH, j-l} \quad T_L = T_{LEAD}$

Mounting Instructions

1. Solder the copper pad on the backside of the device package to the ground plane.
2. Use a large ground pad area with many plated through-holes as shown.
3. We recommend 1 or 2 ounce copper. Measurement for this datasheet were made on a 31 mil thick FR-4 board with 1 ounce copper on both sides.



ESD Class 1C

Appropriate precautions in handling, packaging and testing devices must be observed.

MSL (Moisture Sensitivity Level) Rating: Level 1

Suggested PCB Pad Layout

Dimensions in inches [millimeters]

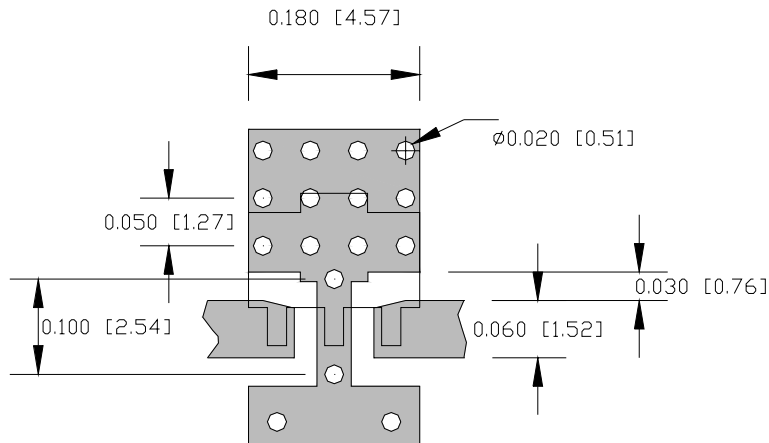

Nominal Package Dimensions

Dimensions in inches (millimeters)

Refer to package drawing posted at www.sirenza.com for tolerances

Bottom View

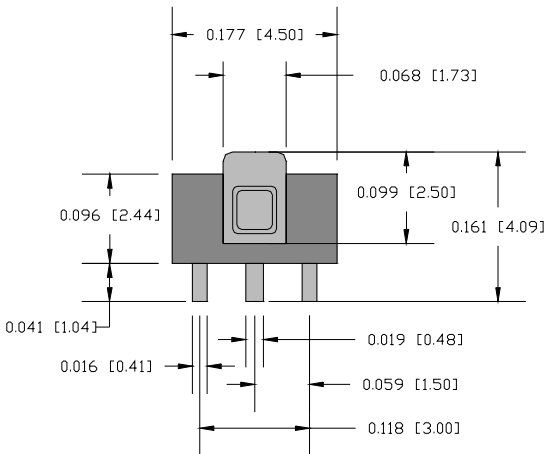

Side View

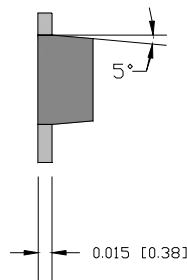

Package Marking

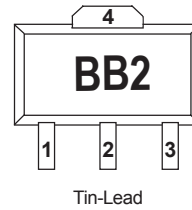

Part Number Ordering Information

Part Number	Reel Size	Devices / Reel
SBB-2089	7"	1000
SBB-2089Z	7"	1000

Pin #	Function	Description
1	RF IN	RF input pin. This pin requires the use of an external DC blocking capacitor chosen for the frequency of operation.
2, 4	GND	Connection to ground. Use via holes for best performance to reduce lead inductance as close to ground leads as possible
3	RF OUT/ BIAS	RF output and bias pin. DC voltage is present on this pin, therefore a DC blocking capacitor is necessary for proper operation.