

**1.5A ULTRA LOW DROPOUT LINEAR REGULATOR****AZ39151****General Description**

The AZ39151 is a 1.5A, high accuracy linear voltage regulator. It features 375mV dropout voltage at 1.5A output current and low ground current over all operating conditions .

The AZ39151 is specifically designed for low voltage, high current output systems, such as PC add-in cards where their tiny dropout voltage and ground current values are important attributes.

The AZ39151 has 5.0V version only.

The AZ39151 is available in TO-252-4 (PPAK) package.

Features

- Minimum Guaranteed Output Current: 1.5A
- Low Dropout Voltage: 375mV at $I_{OUT}=1.5A$
- Output Accuracy: $\pm 1\%$
- Low Ground Current
- Internal Current and Thermal Limit
- Reversed-battery and Reversed-lead Insertion Protection
- Fast Transient Response
- TTL/CMOS Compatible Enable Pin

Applications

- Set-top Box
- Hi-end DVD Player/Recorder
- LCD TV/PDP
- LDO Linear Regulator for PC Add-in Cards
- High Efficiency Linear Power Supplies
- SMPS Post Regulator

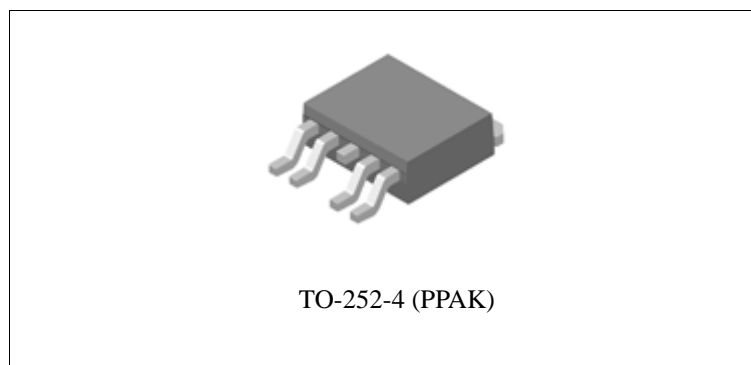

Figure 1. Package Type of AZ39151

**1.5A ULTRA LOW DROPOUT LINEAR REGULATOR****AZ39151****Pin Configuration**D4 Package
TO-252-4 (PPAK)

Figure 2. Pin Configuration of AZ39151 (Top View)

Pin Description

| Pin Number | Pin Name | Function |
|------------|------------------|--|
| 1 | EN | Enable: TTL/CMOS compatible input. Logic high=enable; Logic low or open=shutdown |
| 2 | V _{IN} | Unregulated input |
| 3 | GND | Ground pin. This pin and TAB are internally connected |
| 4 | V _{OUT} | Regulated output |
| 5 | NC | No connection |

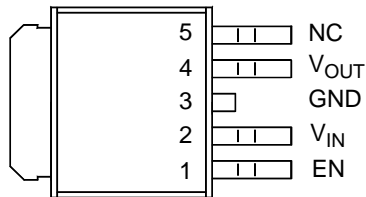

1.5A ULTRA LOW DROPOUT LINEAR REGULATOR **AZ39151**

Functional Block Diagram

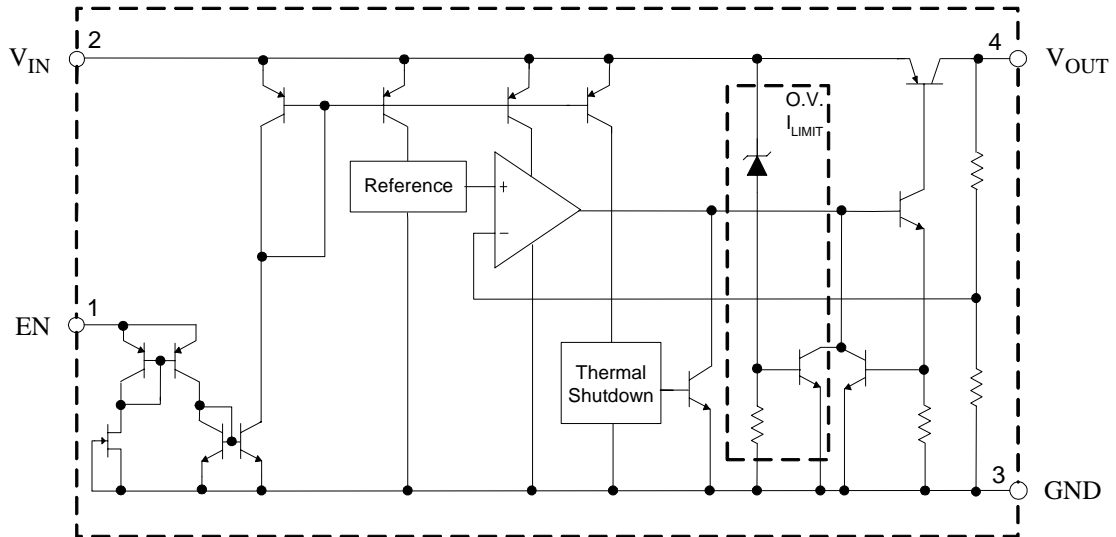
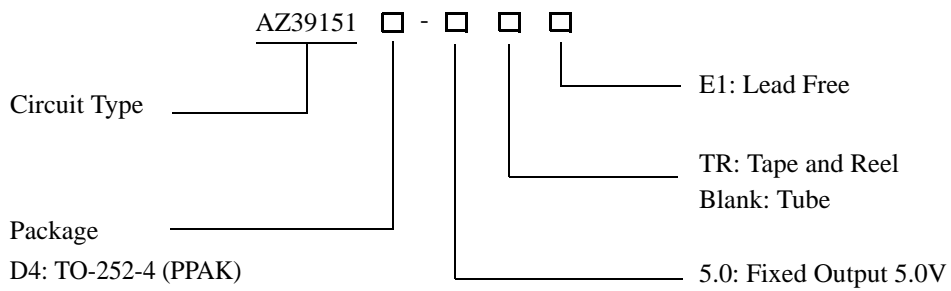

Figure 3. Functional Block Diagram of AZ39151

Ordering Information



**1.5A ULTRA LOW DROPOUT LINEAR REGULATOR****AZ39151****Ordering Information (Continued)**

| Package | Temperature Range | Part Number | Marking ID | Packing Type |
|--------------------|-------------------|-------------------|-----------------|--------------|
| TO-252-4 (PPAK) | -40 to 125°C | AZ39151D4-5.0E1 | AZ39151D4-5.0E1 | Tube |
| | | AZ39151D4-5.0TRE1 | AZ39151D4-5.0E1 | Tape & Reel |

BCD Semiconductor's Pb-free products, as designated with "E1" suffix in the part number, are RoHS compliant.

Absolute Maximum Ratings (Note 1)

| Parameter | Symbol | Value | | Unit |
|-------------------------------------|---------------|-----------------|-----|------|
| Input Voltage | V_{IN} | 15 | | V |
| Enable Voltage | V_{EN} | 15 | | V |
| Operating Junction Temperature | T_J | 150 | | °C |
| Storage Temperature Range | T_{STG} | -65 to 150 | | °C |
| Lead Temperature (Soldering, 10sec) | T_{LEAD} | 260 | | °C |
| ESD (Human Body Model) | ESD | 5000 | | V |
| ESD (Machine Model) | ESD | 450 | | V |
| Thermal Resistance | θ_{JA} | TO-252-4 (PPAK) | 100 | °C/W |

Note 1: Stresses greater than those listed under "Absolute Maximum Ratings" may cause permanent damage to the device. These are stress ratings only, and functional operation of the device at these or any other conditions beyond those indicated under "Recommended Operating Conditions" is not implied. Exposure to "Absolute Maximum Ratings" for extended periods may affect device reliability.

Recommended Operating Conditions

| Parameter | Symbol | Min | Max | Unit |
|--------------------------------|----------|-----|------|------|
| Input Voltage | V_{IN} | | 13.5 | V |
| Enable Voltage | V_{EN} | | 13.5 | V |
| Operating Junction Temperature | T_J | -40 | 125 | °C |



1.5A ULTRA LOW DROPOUT LINEAR REGULATOR

AZ39151

Electrical Characteristics

Operating Conditions: $V_{IN}=6V$, $I_{OUT}=10mA$, $C_{IN}=10\mu F$, $C_{OUT}=10\mu F$, $T_J=25^\circ C$, unless otherwise specified. The **Boldface** applies over $-40^\circ C \leq T_J \leq 125^\circ C$.

| Parameter | Symbol | Conditions | Min | Ma | Unit | | |
|---|-------------------------------------|---|-----------------|------------|------------|------------------|----|
| Output Voltage | V_{OUT} | | -1 | 1 | % | | |
| | | $10mA \leq I_{OUT} \leq 1.5A$, $6V \leq V_{IN} \leq 13.5V$ | -2 | 2 | | | |
| Line Regulation | V_{RLINE} | $6V \leq V_{IN} \leq 13.5V$ | | 3 | 25 | mV | |
| Load Regulation | V_{RLOAD} | $10mA \leq I_{OUT} \leq 1.5A$ | | 10 | 50 | mV | |
| Output Voltage Temperature Coefficient (Note 2) | $\Delta V_{OUT}/\Delta T$ | | | 100 | 500 | $\mu V/^\circ C$ | |
| | $(\Delta V_{OUT}/V_{OUT})/\Delta T$ | | | 20 | 100 | ppm/ $^\circ C$ | |
| Dropout Voltage (Note 3) | V_{DROP} | $\Delta V_{OUT}=1\%$ | $I_{OUT}=100mA$ | | 80 | 200 | mV |
| | | | $I_{OUT}=750mA$ | | 260 | | mV |
| | | | $I_{OUT}=1.5A$ | | 375 | 700 | mV |
| Ground Current | I_{GND} | $I_{OUT}=750mA$ | | 5 | 10 | mA | |
| | | $I_{OUT}=1.5A$ | | 17 | 34 | mA | |
| Standby Current | I_{STD} | $V_{IN}=13.5V$, $V_{EN}=0V$ | | 130 | 220 | μA | |
| Dropout Ground Pin Current | $I_{GND(DO)}$ | $V_{IN} \leq V_{OUT(NOMINAL)} - 0.5V$ | | 5 | | mA | |
| Short Circuit Current | I_{SHORT} | $V_{OUT}=0V$ | | 2.8 | | A | |
| Output Noise Voltage (rms) | | 10Hz to 100kHz, $I_{OUT}=100mA$ | | 200 | | μV | |
| Minimum Load Current | $I_{LOAD(MIN)}$ | | | | 5 | mA | |
| Power Supply Ripple Rejection | PSRR | $f=120Hz$, $I_{OUT}=750mA$ | 49 | 65 | | dB | |
| Enable Input | | | | | | | |
| Enable Voltage | V_{EN} | Logic low (off) | | | 0.8 | V | |
| | | Logic high (on) | 2.25 | | | | |
| Enable Current | I_{EN} | $V_{EN}=V_{IN}$ | | 15 | 35 | μA | |
| | | $V_{EN}=0.8V$ | | | 4 | | |
| Shutdown Output Current | $I_{OUT(SHDN)}$ | $V_{EN} \leq 0.8V$, $V_{IN} \leq 8V$, $V_{OUT}=0V$ | | 5 | 10 | μA | |

Note 2: Output voltage temperature coefficient is defined as the worst case voltage change divided by the total temperature range.

Note 3: Dropout voltage is defined as the input-to-output differential when the output voltage drops to 99% of its nominal value which is measured at $V_{OUT}+1V$ applied to V_{IN} .



1.5A ULTRA LOW DROPOUT LINEAR REGULATOR

AZ39151

Typical Performance Characteristics

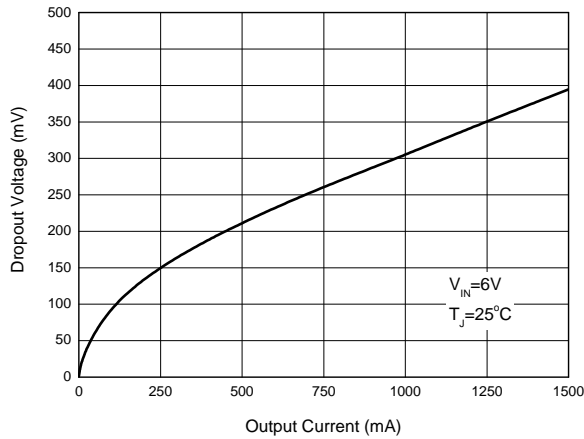

Figure 4. Dropout Voltage vs. Output Current

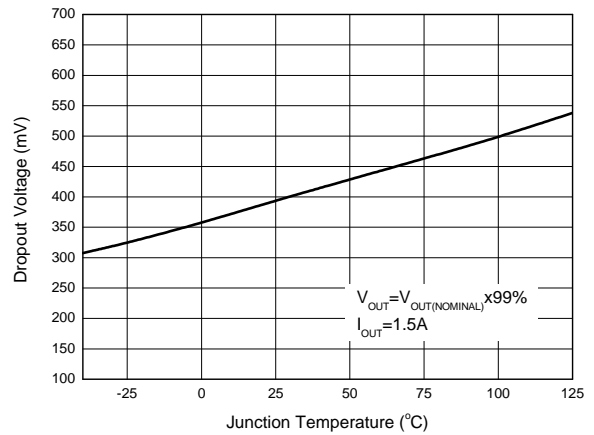

Figure 5. Dropout Voltage vs. Junction Temperature

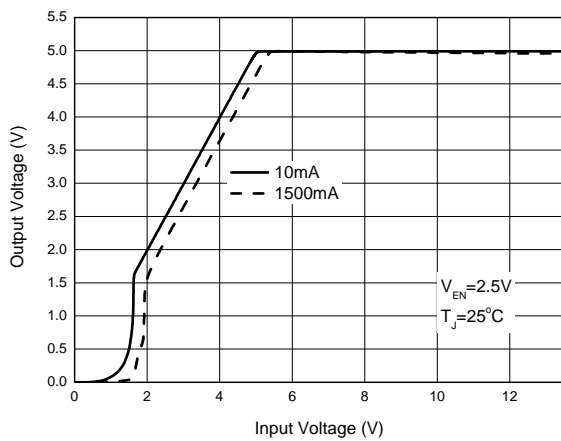

Figure 6. Output Voltage vs. Input Voltage

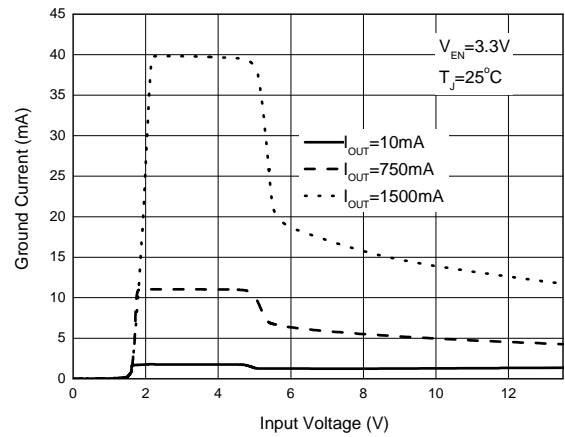

Figure 7. Ground Current vs. Input Voltage



1.5A ULTRA LOW DROPOUT LINEAR REGULATOR

AZ39151

Typical Performance Characteristics (Continued)

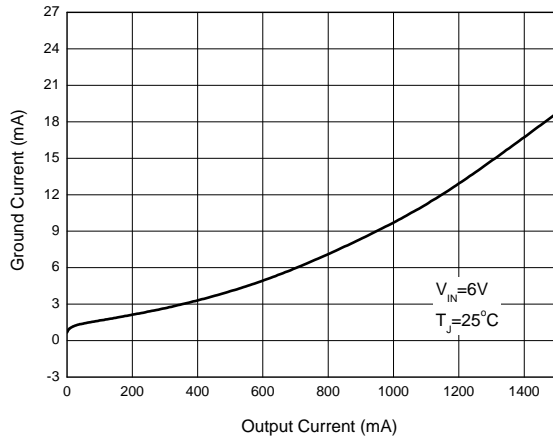

Figure 8. Ground Current vs. Output Current

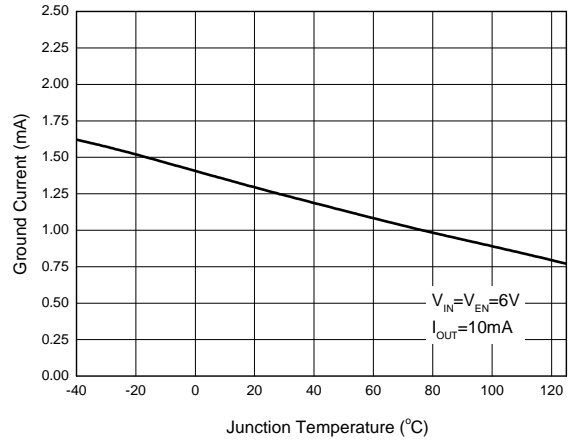

Figure 9. Ground Current vs. Junction Temperature

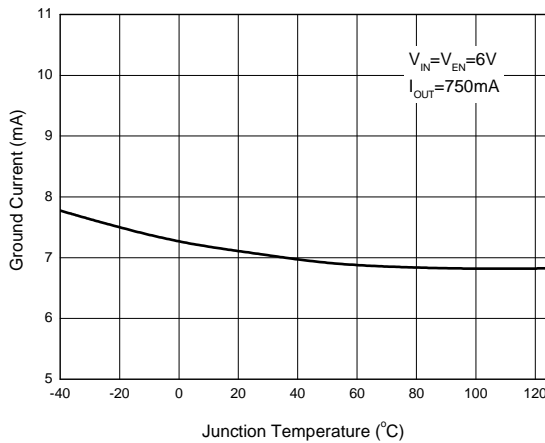

Figure 10. Ground Current vs. Junction Temperature

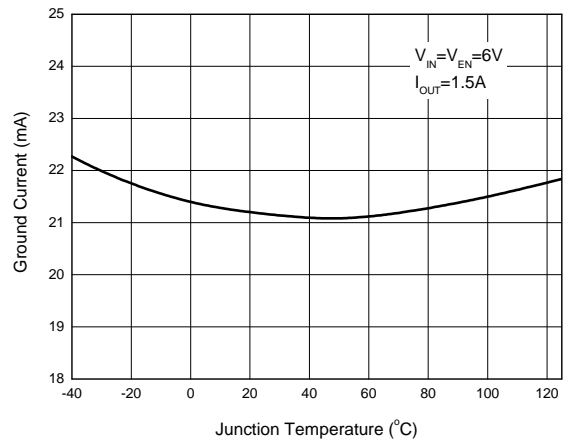

Figure 11. Ground Current vs. Junction Temperature



1.5A ULTRA LOW DROPOUT LINEAR REGULATOR

AZ39151

Typical Performance Characteristics (Continued)

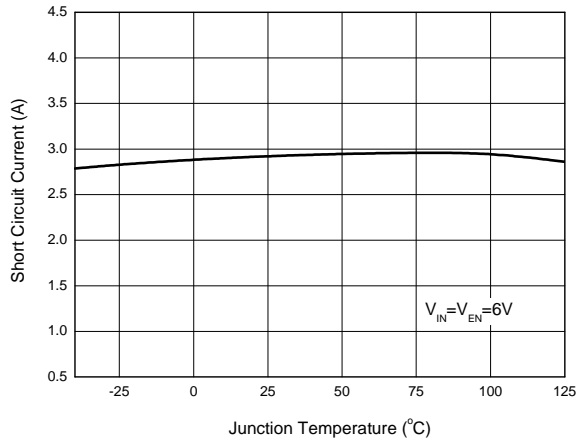

Figure 12. Short Circuit Current vs. Junction Temperature

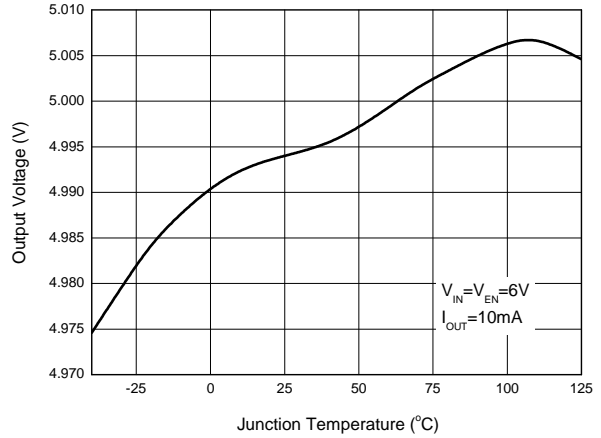

Figure 13. Output Voltage vs. Junction Temperature

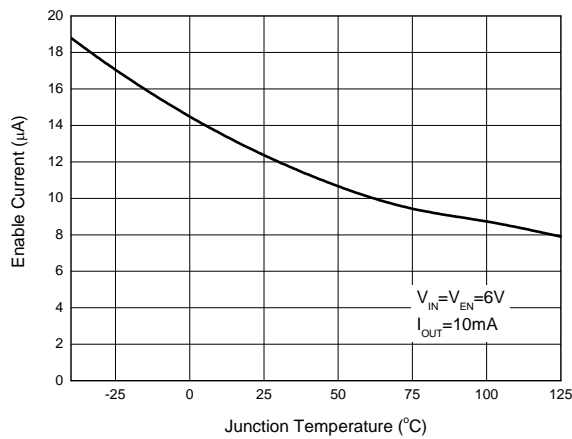

Figure 14. Enable Current vs. Junction Temperature

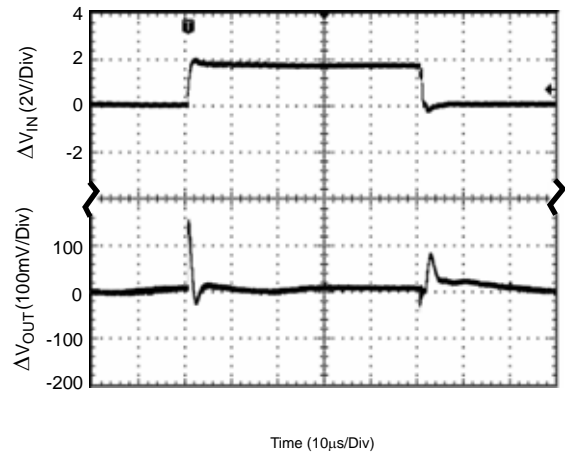

Figure 15. Line Transient
(Conditions: $V_{IN}=5$ to $7V$, $I_{OUT}=1.5A$, $C_{OUT}=10µF$)



1.5A ULTRA LOW DROPOUT LINEAR REGULATOR

AZ39151

Typical Performance Characteristics (Continued)

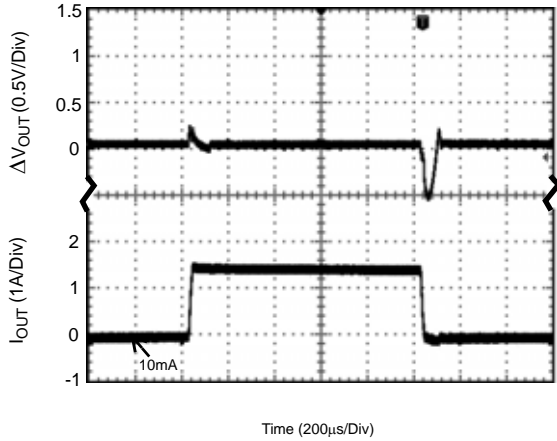

Figure 16. Load Transient

(Conditions: $V_{IN}=6V$, $I_{OUT}=10mA$ to $1.5A$, $C_{IN}=C_{OUT}=10\mu F$)

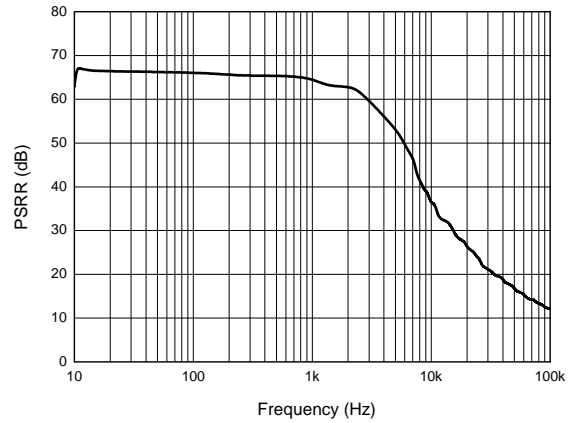

Figure 17. PSRR vs. Frequency

(Conditions: $V_{IN}=6V$, $I_{OUT}=10mA$, $C_{IN}=C_{OUT}=10\mu F$)

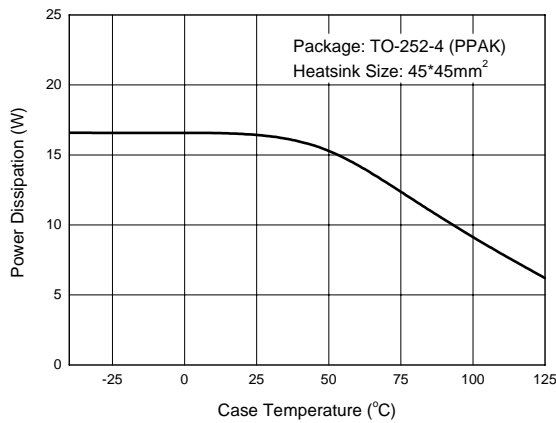

Figure 18. Power Dissipation vs. Case Temperature



1.5A ULTRA LOW DROPOUT LINEAR REGULATOR

AZ39151

Typical Application

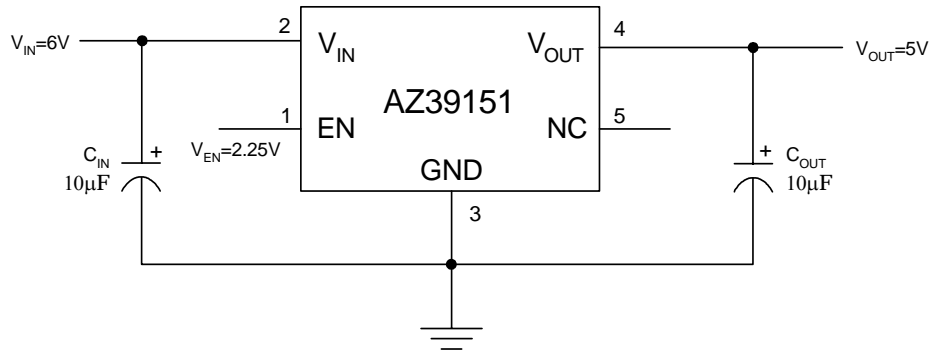

Figure 19. Typical Application of AZ39151



1.5A ULTRA LOW DROPOUT LINEAR REGULATOR

AZ39151

Mechanical Dimensions

TO-252-4 (PPAK)

Unit: mm(inch)

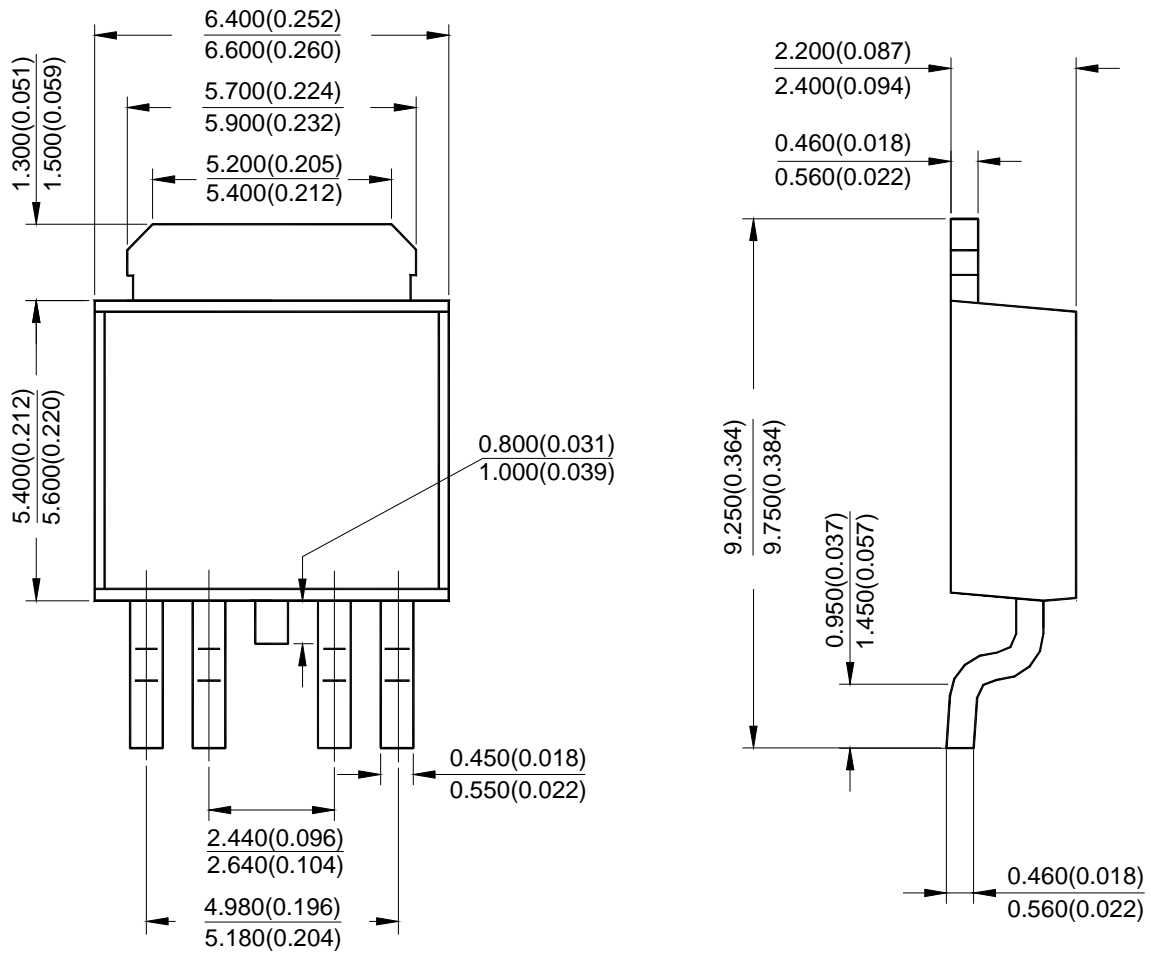



BCD Semiconductor Manufacturing Limited

<http://www.bcdsemi.com>

IMPORTANT NOTICE

BCD Semiconductor Manufacturing Limited reserves the right to make changes without further notice to any products or specifications herein. BCD Semiconductor Manufacturing Limited does not assume any responsibility for use of any its products for any particular purpose, nor does BCD Semiconductor Manufacturing Limited assume any liability arising out of the application or use of any its products or circuits. BCD Semiconductor Manufacturing Limited does not convey any license under its patent rights or other rights nor the rights of others.

MAIN SITE

BCD Semiconductor Manufacturing Limited
- Wafer Fab
Shanghai SIM-BCD Semiconductor Manufacturing Limited
800, Yi Shan Road, Shanghai 200233, China
Tel: +86-21-6485 1491, Fax: +86-21-5450 0008

BCD Semiconductor Manufacturing Limited
- IC Design Group
Advanced Analog Circuits (Shanghai) Corporation
8F, Zone B, 900, Yi Shan Road, Shanghai 200233, China
Tel: +86-21-6495 9539, Fax: +86-21-6485 9673

REGIONAL SALES OFFICE

Shenzhen Office
Shanghai SIM-BCD Semiconductor Manufacturing Co., Ltd. Shenzhen Office
Advanced Analog Circuits (Shanghai) Corporation Shenzhen Office
Room E, 5F, Noble Center, No.1006, 3rd Fuzhong Road, Futian District, Shenzhen 518026, China
Tel: +86-755-8826 7951
Fax: +86-755-8826 7865

Taiwan Office
BCD Semiconductor (Taiwan) Company Limited
4F, 298-1, Rui Guang Road, Nei-Hu District, Taipei,
Taiwan
Tel: +886-2-2656 2808
Fax: +886-2-2656 2806

USA Office
BCD Semiconductor Corporation
30920 Huntwood Ave. Hayward,
CA 94544, U.S.A
Tel : +1-510-324-2988
Fax: +1-510-324-2788