



Low-Power Precision Voltage Detector

FEATURES

- Ultra Low Current Consumption 2.4μA
- Accurate Voltage Detection Threshold
- Fine Voltage Detection Threshold Resolution
- Active Low Open Drain Output
- Available in 5-pin TSOT- 23 and 3-pin SOT- 89 RoHS compliant packages
- Industrial temperature range -40°C to +85°C

APPLICATIONS

- Battery-Powered Systems
- Power Supply Monitoring
- Handheld and Portable Equipment
- Processor Supervisor Reset

DESCRIPTION

The CAT808 is a high-precision voltage detector designed for monitoring single cell and multi-cell batteries. Voltage detection thresholds between 2.0V and 3.2V are provided with 0.1V resolution and ±3.0% accuracy.

The CAT808 open-drain output is active low until the V_{DD} voltage exceeds the detection threshold. A low hysteresis is built into the device to minimize output “chatter”, while V_{DD} passes through the detection threshold, and the output transitions high.

After the CAT808 asserts the output high condition, it continues to monitor V_{DD} until it drops below the detection threshold, when the output goes low until V_{DD} once again exceeds the detection threshold.

For Ordering Information details, see page 7.

PIN CONFIGURATION

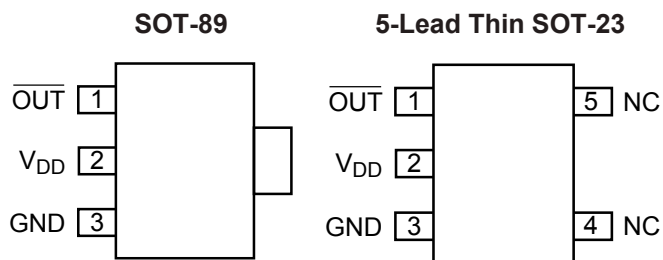

TYPICAL APPLICATION

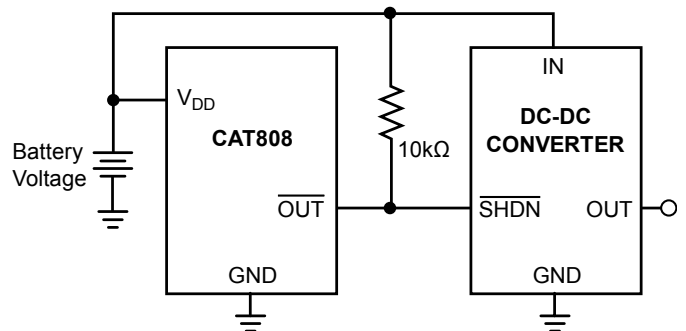

Note: The value of the pull-up resistor is not critical

CAT808
ABSOLUTE MAXIMUM RATINGS⁽¹⁾

Parameters		Ratings	Units
Temperature under Bias		-55 to +125	°C
Storage Temperature		-65 to +150	°C
Voltage on any Pin with Respect to GND ⁽²⁾⁽³⁾		-2.0 to V _{DD} + 2.0	V
V _{DD} with Respect to GND		-2.0 to 7.0	V
Lead Soldering temperature (10 seconds)		+300	°C
Power Dissipation	TSOT-23-5	250	mW
	SOT-89	500	mW

RECOMMENDED OPERATING CONDITIONS

Parameters		Ratings	Units
V _{DD}		+1.2 to +6.0	V
Operating Temperature Range		-40 to +85	°C

DC ELECTRICAL CHARACTERISTICS

 T_A = -40°C to +85°C, V_{DD} = 1.2V to 6.0V

Symbol	Parameter	Conditions	Min	Typ.	Max	Units	
V _{DET}	Detection Voltage, 27	T _A = -40°C to +85°C	2.62	2.7	2.78	V	
V _{DET}	Detection Voltage, 32	T _A = -40°C to +85°C	3.12	3.2	3.28		
I _{DD}	Current Consumption	V _{DD} = 4.0V	-	2.4	5	μA	
		V _{DD} = 5.0V	-	3.5	7		
		V _{DD} = 6.0V	-	5	10		
I _{OUT}	Output Sink Current	V _{DS} = 0.5V	V _{DD} =1.2V	0.6	1.4	-	mA
			V _{DD} =2.4V	2.9	5	-	
I _{LEAK}	Output Leakage Current	V _{DS} = 5.0V, V _{DD} = 5.0V	-	-	1	μA	
T _{PHL/LH}	Response Time	-	-	-	60	μs	
$\frac{\Delta - V_{DET}}{\Delta T_A \bullet -V_{DET}}$	Detection Voltage Temperature Coefficient ⁽⁴⁾	T _A = -40°C to +85°C	-	±10	±100	ppm/°C	

Notes:

- Stresses above those listed under "Absolute Maximum Ratings" may cause permanent damage to the device. These are stress ratings only and functional operation of the devices at these or any other conditions outside of those listed in the operational sections of this specification is not implied. Exposure to any absolute maximum rating for extended periods may affect device performance and reliability.
- The Minimum DC input voltage is -0.5V. During transitions, inputs may undershoot to -2.0V for periods of less than 20ns. Maximum DC voltage on output pins is V_{CC} +0.5V, which may overshoot to V_{CC} +2.0V for periods of less than 20ns.
- Latch-up protection is provided for stresses up to 100mA on all pins from -1V to V_{CC} +1V.
- The temperature change ratio in the detection voltage [ppm/°C] is calculated by using the following equation:

$$\frac{\Delta - V_{DET}}{\Delta T_A \bullet -V_{DET}} \times 1,000,000 [\text{ppm}/^\circ\text{C}]$$

OPERATION – VOLTAGE DETECTOR

The CAT808 has an active low output that asserts (pulls low) when the supply voltage drops below the detection threshold voltage (V_{DET}). The open-drain output requires an external pull-up resistor between the output pin and the supply voltage (as shown in the typical application diagram). On power-up, \overline{OUT} is held active low until the supply voltage (V_{DD}) rises above V_{DET} . While V_{DD} is above V_{DET} , \overline{OUT} stays high until V_{DD} drops below V_{DET} , then \overline{OUT} once again goes low.

TIMING DIAGRAM

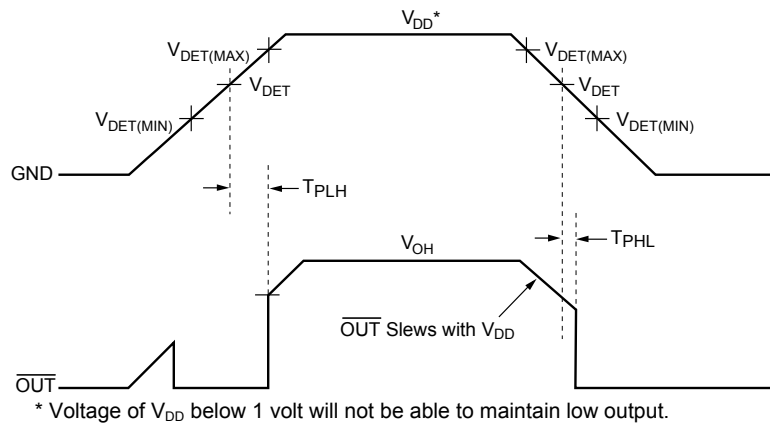

BLOCK DIAGRAM

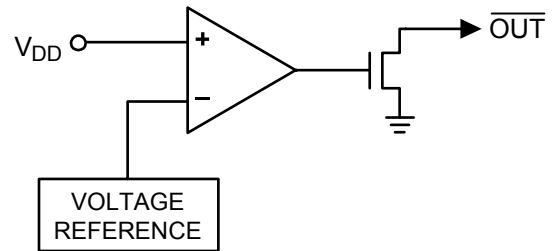

PIN FUNCTIONS

Pin	Function
V_{DD}	Voltage Input and Power Supply
GND	Ground Pin
\overline{OUT}	Active Low Open Drain output
NC	No Connect, the pin is electrically open

TYPICAL ELECTRICAL OPERATING CHARACTERISTICS

Typical values at $T_A = 25^\circ\text{C}$.

V_{DD} Supply Current vs. V_{DD} Supply Voltage

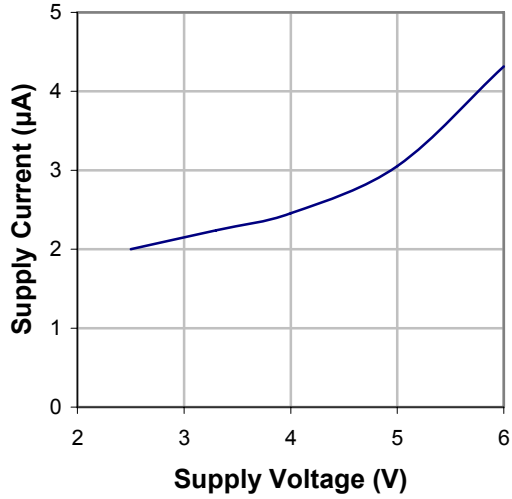

V_{DET} Detection Voltage vs. Temperature

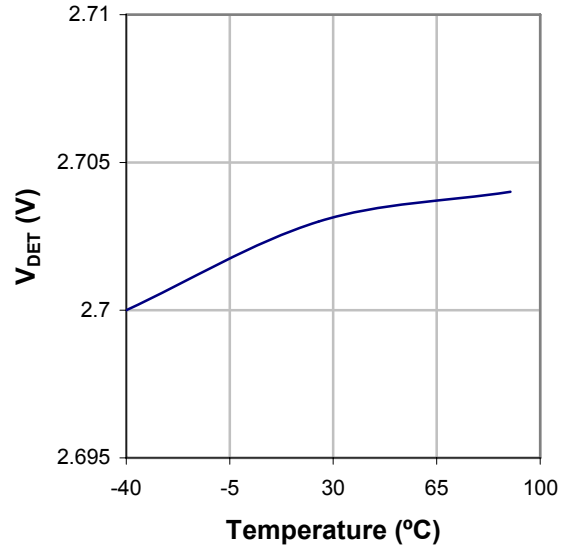

Response time vs. Load Capacitance

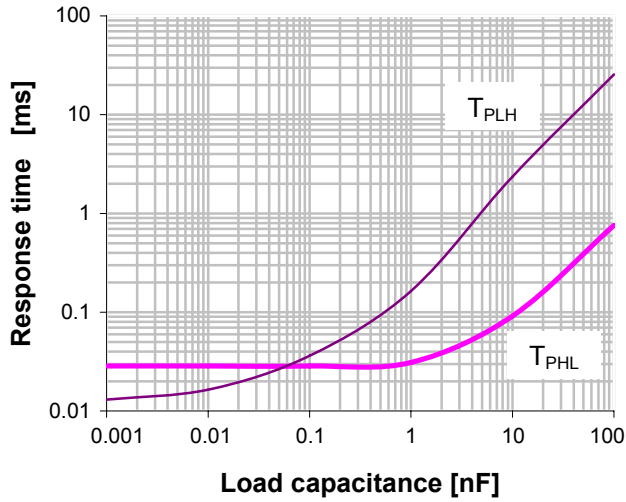

I_{OUT} Transistor Output Current vs. V_{DD} Supply Voltage

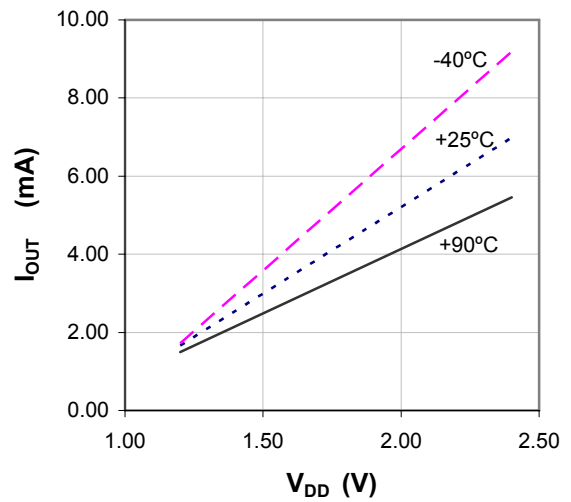

PACKAGE INFORMATION

5-LEAD TSOT-23 PACKAGE

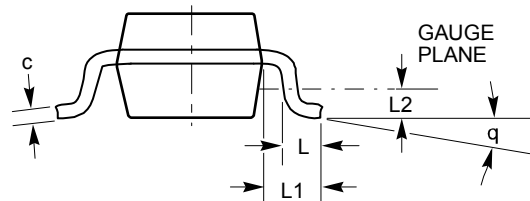
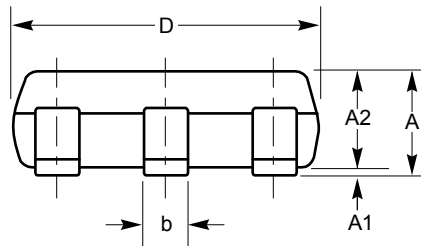
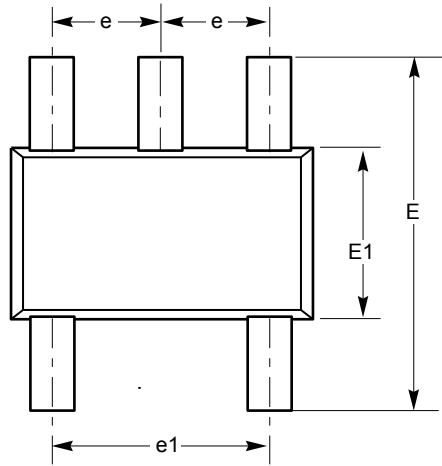

SYMBOL	MIN	NOM	MAX
A	—	—	1.00
A1	0.01	0.05	0.10
A2	0.80	0.87	0.90
b	0.30	—	0.45
c	0.12	0.15	0.20
D	2.90BSC		
E	2.80BSC		
E1	1.60BSC		
e	0.95BSC		
e1	1.90BSC		
L	0.30	0.40	0.50
L1	0.60REF		
L2	0.25BSC		
q	0°		8°

Notes:

- (1) All dimensions are in millimeters.
- (2) Complies with JEDEC specification MO-193.

3-LEAD SOT-89 PACKAGE

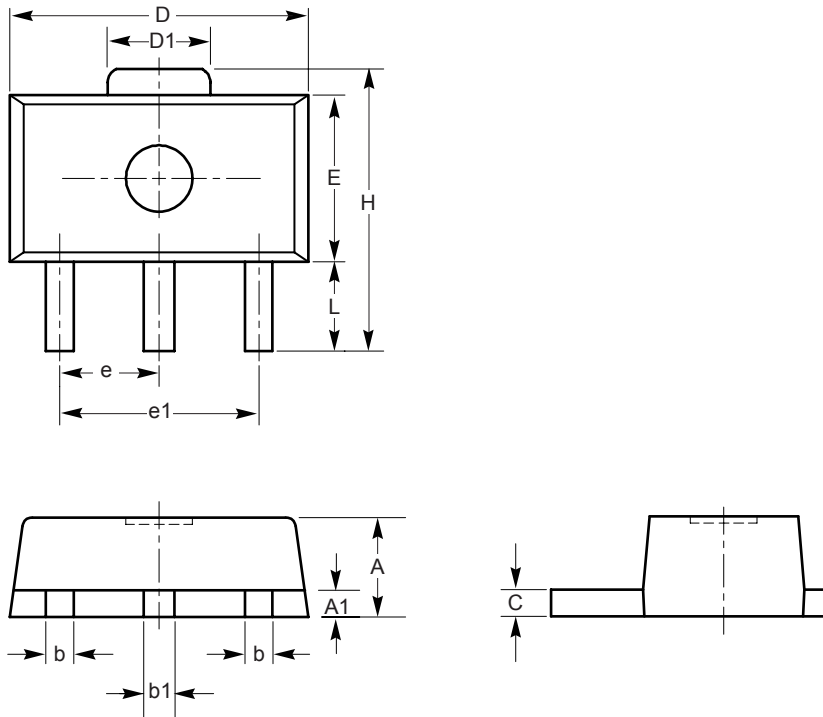

SYMBOL	MIN	NOM	MAX
A	1.40	1.50	1.60
A1	0.30	0.40	0.50
L	0.80	–	1.20
b	0.36	0.42	0.48
b1	0.41	0.47	0.53
C	0.38	0.40	0.43
D	4.40	4.50	4.60
D1	1.40	1.60	1.75
H	3.94	–	4.25
E	2.40	2.50	2.60
e1	2.90	3.00	3.10
e	1.45	1.50	1.55

Notes:

- (1) All dimensions are in millimeters.
- (2) Lead frame material: copper.

EXAMPLE OF ORDERING INFORMATION

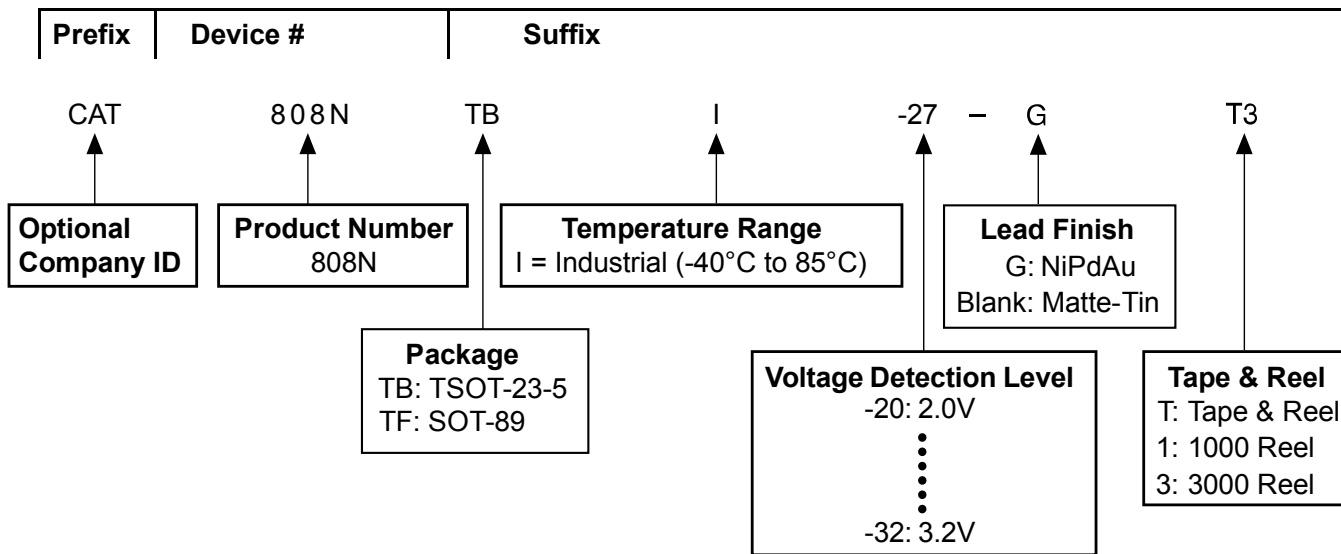

Notes:

- (1) All packages are RoHS-compliant (Lead-free, Halogen-free).
- (2) The standard finish is NiPdAu.
- (3) The device used in the above example is a CAT808NTBI-27-GT3 (TSOT-23-5, Industrial Temperature, 2.7V Detection Level, NiPdAu, Tape & Reel).
- (4) For additional detection voltage, package and temperature options, please contact your nearest Catalyst Semiconductor Sales office.

TOP MARKING

Part Number	Package	Detection Voltage	Top Marking
CAT808NTBI-27-G	TSOT-23-5	2.70	MVym
CAT808NTBI-32-G	TSOT-23-5	3.20	MVym
CAT808NTFI-27	SOT-89	2.70	AAxxx
CAT808NTFI-32	SOT-89	3.20	AAxxx

Notes:

- (1) ym – Year and Month Code.
- (2) xxx – Assembly location code and last 2 digits of assembly lot code.
- (3) SOT-89 is offered in Matte-Tin only.

REVISION HISTORY

Date	Rev.	Reason
11/07/06	A	Initial Issue

Copyrights, Trademarks and Patents

Trademarks and registered trademarks of Catalyst Semiconductor include each of the following:

Beyond Memory™, DPP™, EZDim™, MiniPot™, and Quad-Mode™

Catalyst Semiconductor has been issued U.S. and foreign patents and has patent applications pending that protect its products.

CATALYST SEMICONDUCTOR MAKES NO WARRANTY, REPRESENTATION OR GUARANTEE, EXPRESS OR IMPLIED, REGARDING THE SUITABILITY OF ITS PRODUCTS FOR ANY PARTICULAR PURPOSE, NOR THAT THE USE OF ITS PRODUCTS WILL NOT INFRINGE ITS INTELLECTUAL PROPERTY RIGHTS OR THE RIGHTS OF THIRD PARTIES WITH RESPECT TO ANY PARTICULAR USE OR APPLICATION AND SPECIFICALLY DISCLAIMS ANY AND ALL LIABILITY ARISING OUT OF ANY SUCH USE OR APPLICATION, INCLUDING BUT NOT LIMITED TO, CONSEQUENTIAL OR INCIDENTAL DAMAGES.

Catalyst Semiconductor products are not designed, intended, or authorized for use as components in systems intended for surgical implant into the body, or other applications intended to support or sustain life, or for any other application in which the failure of the Catalyst Semiconductor product could create a situation where personal injury or death may occur.

Catalyst Semiconductor reserves the right to make changes to or discontinue any product or service described herein without notice. Products with data sheets labeled "Advance Information" or "Preliminary" and other products described herein may not be in production or offered for sale.

Catalyst Semiconductor advises customers to obtain the current version of the relevant product information before placing orders. Circuit diagrams illustrate typical semiconductor applications and may not be complete.



Catalyst Semiconductor, Inc.
Corporate Headquarters
2975 Stender Way
Santa Clara, CA 95054
Phone: 408.542.1000
Fax: 408.542.1200
www.catsemi.com

Document No: 3024
Revision: A
Issue date: 11/07/06