

#### Description

- AM Ceramic filters are connected in a ladder structure and are available as either 4/6 element devices
- Bandwidths from 6 to 30 kHz

#### Features

- 450, 455 kHz, (460kHz and 486kHz by special request)
- High selectivity
- Compact package
- Version with group delay variations specified also available
- Lead-free terminations

#### Applications

- AM radio cassettes, AM stereo sets
- Cordless telephones, pagers
- Two-way radios

#### Dimensions

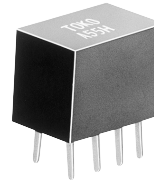

LFY

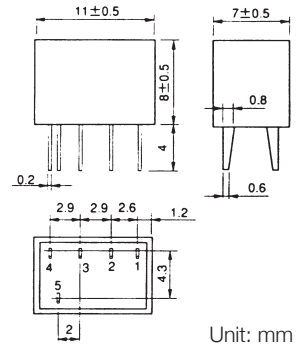

Unit: mm

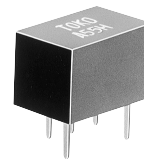

LFYM

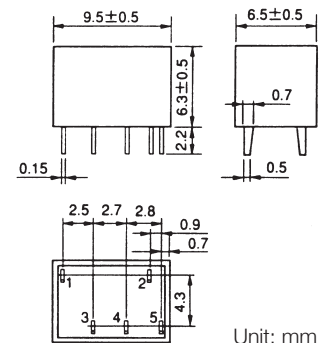

Unit: mm

### STANDARD FILTERS SELECTION GUIDE

#### TYPE LFY/LFYM

TOKO Part Number	Center * Frequency (kHz)	Bandwidth at 6 dB (kHz)	Bandwidth at 50 dB (kHz)	Attenuation fo ± 100 KHz (dB)	Insertion Loss (dB)	Input/Output Impedance (kΩ)
<b>LFY</b>						
ALFY455H	455±1.0	±3.0 min.	±9.0 min.	35.0 max.	6.0 max.	2.0
ALFY455G	455±1.0	±4.5 min.	±10.0 min.	35.0 max.	6.0 max.	2.0
ALFY455F	455±1.0	±6.0 min.	±12.5 min.	35.0 max.	6.0 max.	2.0
ALFY455E	455±1.0	±7.5 min.	±15.0 min.	35.0 max.	6.0 max.	1.5
BLFY455D	455±2.0	±10.0 min.	±20.0 min.	35.0 max.	4.0 max.	1.5
BLFY455C	455±2.0	±12.5 min.	±24.0 min.	35.0 max.	4.0 max.	1.5
BLFY455B	455±2.0	±15.0 min.	±30.0 min.	35.0 max.	4.0 max.	1.5
<b>LFYM</b>						
ALFYM455H	455±1.0	±3.0 min.	±9.0 min.	35.0 max	6.0 max.	2.0
ALFYM455G	455±1.0	±4.5 min.	±10.0 min.	35.0 max	6.0 max.	2.0
ALFYM455F	455±1.0	±6.0 min.	±12.5 min.	35.0 max	6.0 max.	2.0
ALFYM455E	455±1.0	±7.5 min.	±15.0 min.	35.0 max	6.0 max.	1.5
BLFYM455D	455±2.0	±10.0 min.	±20.0 min.	35.0 max	4.0 max.	1.5
BLFYM455C	455±2.0	±12.5 min.	±24.0 min.	35.0 max	4.0 max.	1.5
BLFYM455B	455±2.0	±15.0 min.	±30.0 min.	35.0 max	4.0 max.	1.5

\* For 450kHz, substitute 450 for 455 in part number.

### Frequency Response

LFY / LFYM (6 element)

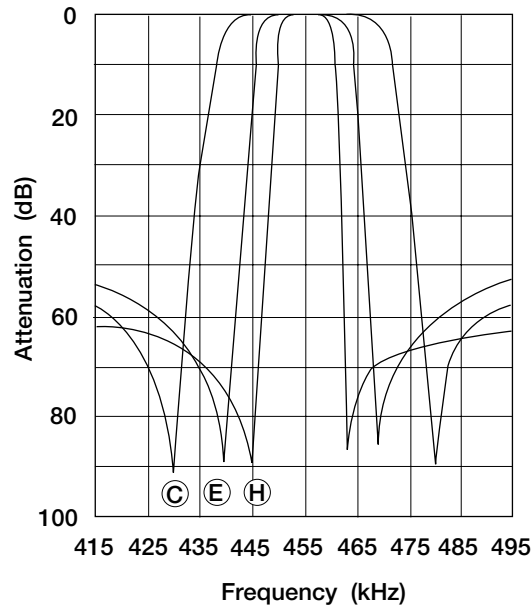

Bandwidth  
Rank:  
C = ±12.5kHz  
E = ±7.5kHz  
H = ±3kHz

### Test Circuit

#### Test Conditions

1. C includes test circuit capacitance.
2. R<sub>1</sub>, R<sub>2</sub>: Input-output impedance  
C<sub>s</sub>: Stray capacitance  
(less than 50pF, including EV)

#### LFY Test circuit

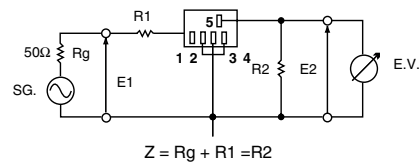

#### LFYM Test circuit

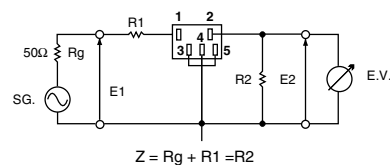

The information furnished by TOKO, Inc. is believed to be accurate and reliable. However, TOKO reserves the right to make changes or improvements in the design, specification or manufacture of its products without further notice. TOKO does not assume any liability arising from the application or use of any product or circuit described herein, nor for any infringements of patents or other rights of third parties which may result from the use of its products. No license is granted by implication or otherwise under any patent or patent rights of TOKO, Inc.