

# Dual octal latched transceivers with dual enable (3-State)

## MB2543

### FEATURES

- Two 8-bit octal transceivers with D-type latch
- Live insertion/extraction permitted
- Power-up 3-State
- Power-up reset
- Multiple V<sub>CC</sub> and GND pins minimize switching noise
- Back-to-back registers for storage
- Separate controls for data flow in each direction

- Output capability: +64mA/−32mA
- Latch-up protection exceeds 500mA per Jedec JC40.2 Std 17
- ESD protection exceeds 2000V per MIL STD 883 Method 3015 and 200V per Machine Model

### DESCRIPTION

The MB2543 high-performance BiCMOS device combines low static and dynamic

power dissipation with high speed and high output drive.

The MB2543 dual octal registered transceiver contains two sets of D-type latches for temporary storage of data flowing in either direction. Separate Latch Enable (nLEAB, nLEBA) and Output Enable (nOEAB, nOEBA) inputs are provided for each register to permit independent control of data transfer in either direction. The outputs are guaranteed to sink 64mA.

### QUICK REFERENCE DATA

SYMBOL	PARAMETER	CONDITIONS T <sub>amb</sub> = 25°C; GND = 0V	TYPICAL	UNIT
t <sub>PLH</sub> t <sub>PHL</sub>	Propagation delay nAx to nBx	C <sub>L</sub> = 50pF; V <sub>CC</sub> = 5V	3.3	ns
C <sub>IN</sub>	Input capacitance	V <sub>I</sub> = 0V or V <sub>CC</sub>	4	pF
C <sub>I/O</sub>	I/O capacitance	V <sub>O</sub> = 0V or V <sub>CC</sub> ; 3-State	7	pF
I <sub>CCZ</sub>	Total supply current	Outputs disabled; V <sub>CC</sub> = 5.5V	120	μA

### ORDERING INFORMATION

PACKAGES	TEMPERATURE RANGE	ORDER CODE	DRAWING NUMBER
52-pin plastic Quad Flat Pack	−40°C to +85°C	MB2543BB	1418B

### PIN CONFIGURATION

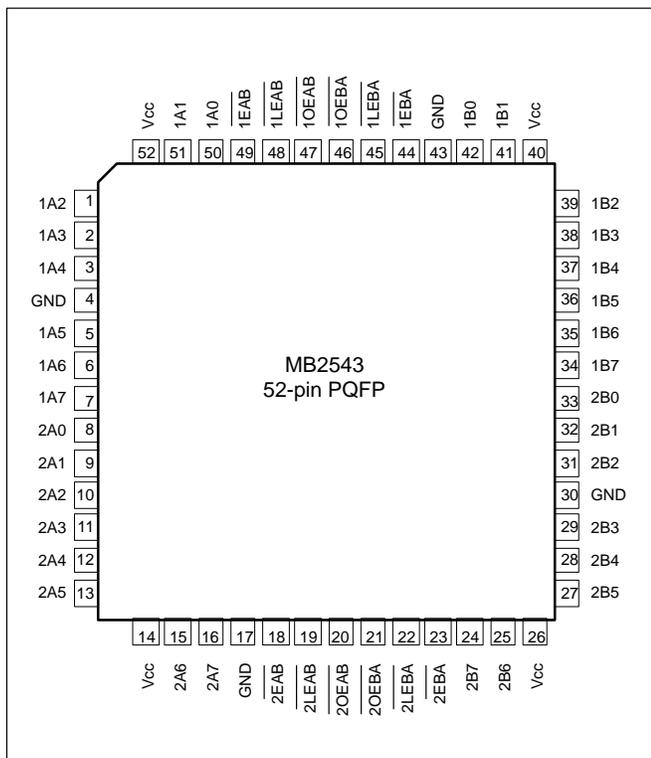

### LOGIC SYMBOL

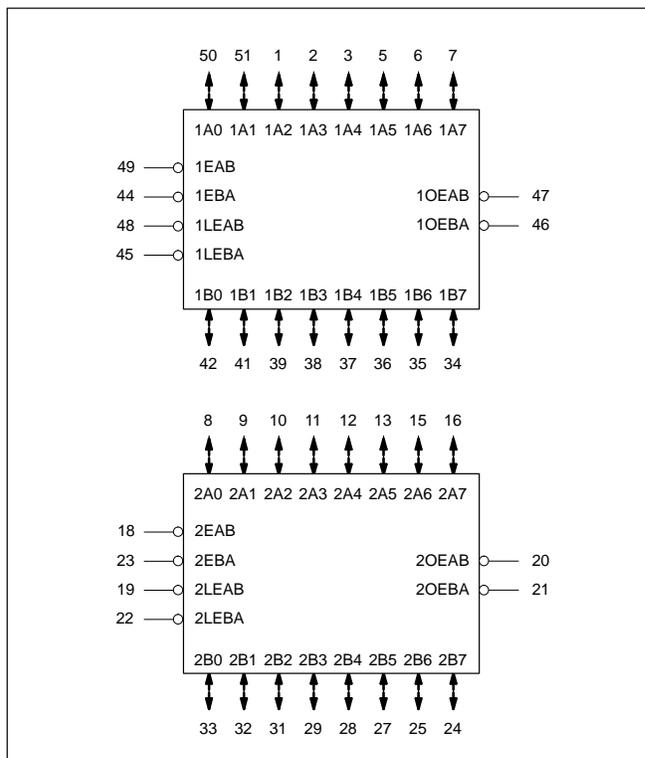

# Dual octal latched transceivers with dual enable (3-State)

MB2543

## LOGIC DIAGRAM

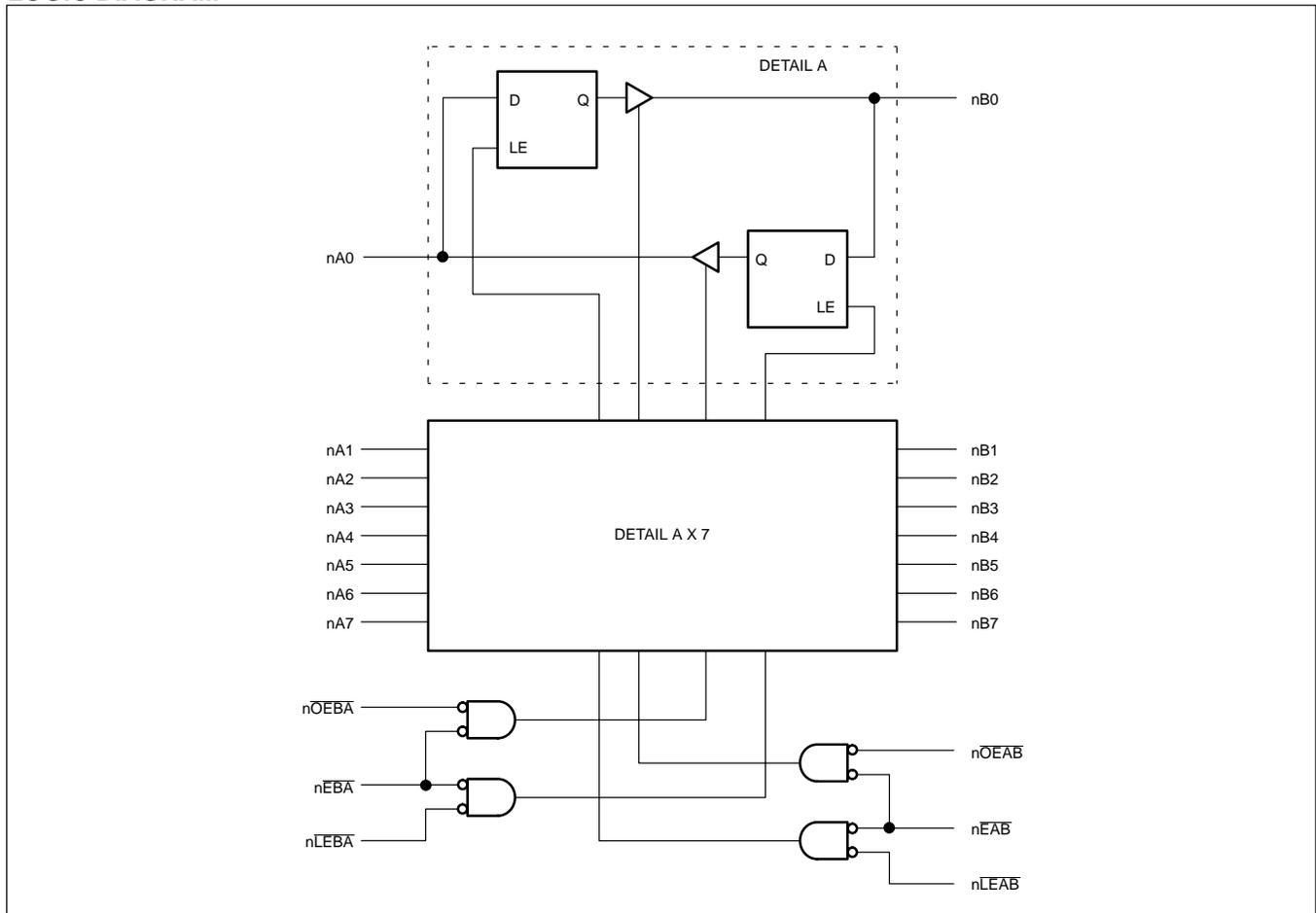

## LOGIC SYMBOL (IEEE/IEC)

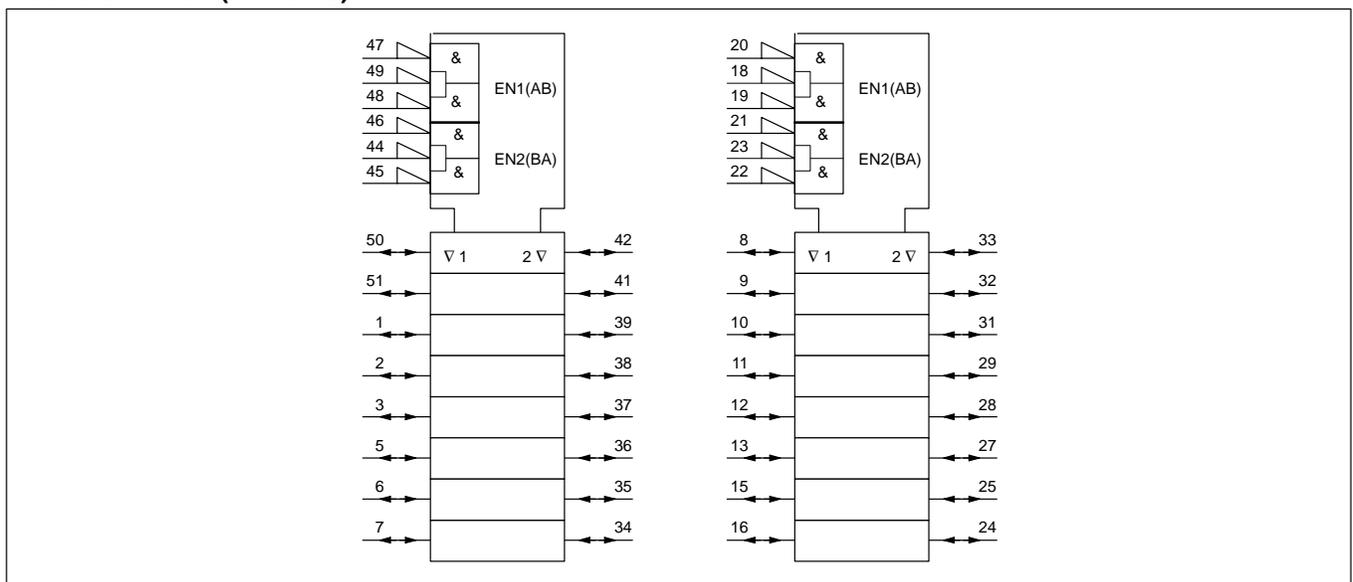

# Dual octal latched transceivers with dual enable (3-State)

MB2543

## FUNCTIONAL DESCRIPTION

The MB2543 contains two sets of eight D-type latches, with separate control pins for each set. Using data flow from A to B as an example, when the A-to-B Enable ( $\overline{nEAB}$ ) input and the A-to-B Latch Enable ( $\overline{nLEAB}$ ) input are Low the A-to-B path is transparent.

A subsequent Low-to-High transition of the  $\overline{nLEAB}$  signal puts the A data into the latches where it is stored and the B outputs no longer change with the A inputs. With  $\overline{EAB}$  and  $\overline{nOEAB}$  both Low, the 3-State B output

buffers are active and display the data present at the outputs of the A latches.

Control of data flow from B to A is similar, but using the  $\overline{nEB\overline{A}}$ ,  $\overline{nLEBA}$ , and  $\overline{nOEBA}$  inputs.

## PIN DESCRIPTION

PIN NUMBER	SYMBOL	NAME AND FUNCTION
50, 51, 1, 2, 3, 5, 6, 7, 8, 9, 10, 11, 12, 13, 15, 16	1A0 – 1A7, 2A0 – 2A7	Data inputs/outputs
42, 41, 39, 38, 37, 36, 35, 34, 33, 32, 31, 29, 28, 27, 25, 24	1B0 – 1B7, 2B0 – 2B7	Data inputs/outputs
47, 46, 20, 21	$\overline{1OEAB}$ , $\overline{1OEBA}$ , $\overline{2OEAB}$ , $\overline{2OEBA}$	A to B / B to A Output Enable inputs (active-Low)
49, 44, 18, 23	$\overline{1EAB}$ , $\overline{1EBA}$ , $\overline{2EAB}$ , $\overline{2EBA}$	A to B / B to A Enable inputs (active-Low)
48, 45, 19, 22	$\overline{1LEAB}$ , $\overline{1LEBA}$ , $\overline{2LEAB}$ , $\overline{2LEBA}$	A to B / B to A Latch Enable inputs (active-Low)
4, 17, 30, 43	GND	Ground (0V)
14, 26, 40, 52	V <sub>CC</sub>	Positive supply voltage

## FUNCTION TABLE

INPUTS				OUTPUTS	STATUS
$\overline{nOE\overline{XX}}$	$\overline{nE\overline{XX}}$	$\overline{nLE\overline{XX}}$	$\overline{nA\overline{x}}$ or $\overline{nB\overline{x}}$	$\overline{nB\overline{x}}$ or $\overline{nA\overline{x}}$	
H	X	X	X	Z	Disabled
X	H	X	X	Z	Disabled
L	↑	L	h	Z	Disabled + Latch
L	↑	L	l	Z	
L	L	↑	h	H	Latch + Display
L	L	↑	l	L	
L	L	L	H	H	Transparent
L	L	L	L	L	
L	L	H	X	NC	Hold

- H = High voltage level
- h = High voltage level one set-up time prior to the Low-to-High transition of  $\overline{nLE\overline{XX}}$  or  $\overline{nE\overline{XX}}$  (XX = AB or BA)
- L = Low voltage level
- l = Low voltage level one set-up time prior to the Low-to-High transition of  $\overline{nLE\overline{XX}}$  or  $\overline{nE\overline{XX}}$  (XX = AB or BA)
- X = Don't care
- ↑ = Low-to-High transition of  $\overline{nLE\overline{XX}}$  or  $\overline{nE\overline{XX}}$  (XX = AB or BA)
- NC = No change
- Z = High impedance or "off" state

# Dual octal latched transceivers with dual enable (3-State)

MB2543

## ABSOLUTE MAXIMUM RATINGS<sup>1, 2</sup>

SYMBOL	PARAMETER	CONDITIONS	RATING	UNIT
$V_{CC}$	DC supply voltage		-0.5 to +7.0	V
$I_{IK}$	DC input diode current	$V_I < 0$	-18	mA
$V_I$	DC input voltage <sup>3</sup>		-1.2 to +7.0	V
$I_{OK}$	DC output diode current	$V_O < 0$	-50	mA
$V_{OUT}$	DC output voltage <sup>3</sup>	output in Off or High state	-0.5 to +5.5	V
$I_{OUT}$	DC output current	output in Low state	128	mA
$T_{stg}$	Storage temperature range		-65 to 150	°C

### NOTES:

1. Stresses beyond those listed may cause permanent damage to the device. These are stress ratings only and functional operation of the device at these or any other conditions beyond those indicated under "recommended operating conditions" is not implied. Exposure to absolute-maximum-rated conditions for extended periods may affect device reliability.
2. The performance capability of a high-performance integrated circuit in conjunction with its thermal environment can create junction temperatures which are detrimental to reliability. The maximum junction temperature of this integrated circuit should not exceed 150°C.
3. The input and output voltage ratings may be exceeded if the input and output current ratings are observed.

## RECOMMENDED OPERATING CONDITIONS

SYMBOL	PARAMETER	LIMITS		UNIT
		Min	Max	
$V_{CC}$	DC supply voltage	4.5	5.5	V
$V_I$	Input voltage	0	$V_{CC}$	V
$V_{IH}$	High-level input voltage	2.0		V
$V_{IL}$	Low-level Input voltage		0.8	V
$I_{OH}$	High-level output current		-32	mA
$I_{OL}$	Low-level output current		64	mA
$\Delta t/\Delta v$	Input transition rise or fall rate	0	10	ns/V
$T_{amb}$	Operating free-air temperature range	-40	+85	°C

Dual octal latched transceivers with dual enable  
(3-State)

MB2543

## DC ELECTRICAL CHARACTERISTICS

SYMBOL	PARAMETER	TEST CONDITIONS	LIMITS					UNIT
			T <sub>amb</sub> = +25°C			T <sub>amb</sub> = -40°C to +85°C		
			MIN	TYP	MAX	MIN	MAX	
V <sub>IK</sub>	Input clamp voltage	V <sub>CC</sub> = 4.5V; I <sub>IK</sub> = -18mA		-0.9	-1.2		-1.2	V
V <sub>OH</sub>	High-level output voltage	V <sub>CC</sub> = 4.5V; I <sub>OH</sub> = -3mA; V <sub>I</sub> = V <sub>IL</sub> or V <sub>IH</sub>	2.5	2.9		2.5		V
		V <sub>CC</sub> = 5.0V; I <sub>OH</sub> = -3mA; V <sub>I</sub> = V <sub>IL</sub> or V <sub>IH</sub>	3.0	3.4		3.0		V
		V <sub>CC</sub> = 4.5V; I <sub>OH</sub> = -32mA; V <sub>I</sub> = V <sub>IL</sub> or V <sub>IH</sub>	2.0	2.4		2.0		V
V <sub>OL</sub>	Low-level output voltage	V <sub>CC</sub> = 4.5V; I <sub>OL</sub> = 64mA; V <sub>I</sub> = V <sub>IL</sub> or V <sub>IH</sub>		0.42	0.55		0.55	V
V <sub>RST</sub>	Power-up output voltage <sup>3</sup>	V <sub>CC</sub> = 5.5V; I <sub>O</sub> = 1mA; V <sub>I</sub> = GND or V <sub>CC</sub>		0.13	0.55		0.55	V
I <sub>I</sub>	Input leakage current	Control pins		±0.01	±1.0		±1.0	μA
		Data pins		±5	±100		±100	μA
I <sub>OFF</sub>	Power-off leakage current	V <sub>CC</sub> = 0.0V; V <sub>O</sub> or V <sub>I</sub> ≤ 4.5V		±5.0	±100		±100	μA
I <sub>PU/PD</sub>	Power-up/down 3-State output current <sup>4</sup>	V <sub>CC</sub> = 2.1V; V <sub>O</sub> = 0.5V; V <sub>I</sub> = GND or V <sub>CC</sub> ; V <sub>OE</sub> = Don't care		±5.0	±50		±50	μA
I <sub>IH</sub> + I <sub>OZH</sub>	3-State output High current	V <sub>CC</sub> = 5.5V; V <sub>O</sub> = 2.7V; V <sub>I</sub> = V <sub>IL</sub> or V <sub>IH</sub>		5.0	50		50	μA
I <sub>IL</sub> + I <sub>OZL</sub>	3-State output Low current	V <sub>CC</sub> = 5.5V; V <sub>O</sub> = 0.5V; V <sub>I</sub> = V <sub>IL</sub> or V <sub>IH</sub>		-5.0	-50		-50	μA
I <sub>CEx</sub>	Output High leakage current	V <sub>CC</sub> = 5.5V; V <sub>O</sub> = 5.5V; V <sub>I</sub> = GND or V <sub>CC</sub>		5.0	50		50	μA
I <sub>O</sub>	Output current <sup>1</sup>	V <sub>CC</sub> = 5.5V; V <sub>O</sub> = 2.5V	-50	-100	-180	-50	-180	mA
I <sub>CCH</sub>	Quiescent supply current	V <sub>CC</sub> = 5.5V; Outputs High, V <sub>I</sub> = GND or V <sub>CC</sub>		120	250		250	μA
I <sub>CCL</sub>		V <sub>CC</sub> = 5.5V; Outputs Low, V <sub>I</sub> = GND or V <sub>CC</sub>		38	60		60	mA
I <sub>CCZ</sub>		V <sub>CC</sub> = 5.5V; Outputs 3-State; V <sub>I</sub> = GND or V <sub>CC</sub>		120	250		250	μA
ΔI <sub>CC</sub>	Additional supply current per input pin <sup>2</sup>	V <sub>CC</sub> = 5.5V; one input at 3.4V, other inputs at V <sub>CC</sub> or GND		0.5	1.5		1.5	mA

## NOTES:

- Not more than one output should be tested at a time, and the duration of the test should not exceed one second.
- This is the increase in supply current for each input at 3.4V.
- For valid test results, data must not be loaded into the flip-flops (or latches) after applying the power.
- This parameter is valid for any V<sub>CC</sub> between 0V and 2.1V, with a transition time of up to 10msec. From V<sub>CC</sub> = 2.1V to V<sub>CC</sub> = 5V ± 10% a transition time of up to 100μsec is permitted.

# Dual octal latched transceivers with dual enable (3-State)

MB2543

## AC CHARACTERISTICS

GND = 0V,  $t_R = t_F = 2.5\text{ns}$ ,  $C_L = 50\text{pF}$ ,  $R_L = 500\Omega$ 

SYMBOL	PARAMETER	WAVEFORM	LIMITS					UNIT
			$T_{\text{amb}} = +25^\circ\text{C}$ $V_{\text{CC}} = +5.0\text{V}$			$T_{\text{amb}} = -40$ to $+85^\circ\text{C}$ $V_{\text{CC}} = +5.0\text{V} \pm 0.5\text{V}$		
			MIN	TYP	MAX	MIN	MAX	
$t_{\text{PLH}}$ $t_{\text{PHL}}$	Propagation delay nAx to nBx, nBx to nAx	2	1.5 1.6	3.2 3.3	4.6 4.6	1.5 1.6	5.2 5.2	ns
$t_{\text{PLH}}$ $t_{\text{PHL}}$	Propagation delay $\overline{\text{LEBA}}$ to nAx, $\overline{\text{LEAB}}$ to nBx	1, 2	1.9 2.1	3.9 4.1	5.3 5.5	1.9 2.1	6.1 6.2	ns
$t_{\text{PZH}}$ $t_{\text{PZL}}$	Output enable time $\overline{\text{OEBA}}$ to nAx, $\overline{\text{OEAB}}$ to nBx	4 5	1.6 2.3	3.6 4.5	5.0 5.9	1.6 2.3	5.8 6.6	ns
$t_{\text{PHZ}}$ $t_{\text{PLZ}}$	Output disable time $\overline{\text{OEBA}}$ to nAx, $\overline{\text{OEAB}}$ to nBx	4 5	1.0 1.4	3.6 3.2	5.0 4.6	1.0 1.4	5.7 5.2	ns
$t_{\text{PZH}}$ $t_{\text{PZL}}$	Output enable time $\overline{\text{EBA}}$ to nAx, $\overline{\text{EAB}}$ to nBx	4 5	1.6 2.3	3.6 4.5	5.0 5.9	1.6 2.3	5.8 6.6	ns
$t_{\text{PHZ}}$ $t_{\text{PLZ}}$	Output disable time $\overline{\text{EBA}}$ to nAx, $\overline{\text{EAB}}$ to nBx	4 5	1.0 1.4	3.6 3.2	5.0 4.6	1.0 1.4	5.7 5.2	ns

## AC SETUP REQUIREMENTS

GND = 0V,  $t_R = t_F = 2.5\text{ns}$ ,  $C_L = 50\text{pF}$ ,  $R_L = 500\Omega$ 

SYMBOL	PARAMETER	WAVEFORM	LIMITS			UNIT
			$T_{\text{amb}} = +25^\circ\text{C}$ $V_{\text{CC}} = +5.0\text{V}$		$T_{\text{amb}} = -40$ to $+85^\circ\text{C}$ $V_{\text{CC}} = +5.0\text{V} \pm 0.5\text{V}$	
			MIN	TYP	MIN	
$t_s(\text{H})$ $t_s(\text{L})$	Setup time nAx to $\overline{\text{LEAB}}$ , nBx to $\overline{\text{LEBA}}$	3	1.0 0.5	0.4 -0.1	1.0 0.5	ns
$t_h(\text{H})$ $t_h(\text{L})$	Hold time nAx to $\overline{\text{LEAB}}$ , nBx to $\overline{\text{LEBA}}$	3	1.0 0.5	0.2 -0.3	1.0 0.5	ns
$t_s(\text{H})$ $t_s(\text{L})$	Setup time nAx to $\overline{\text{EAB}}$ , nBx to $\overline{\text{EBA}}$	3	1.0 0.5	0.2 -0.3	1.0 0.5	ns
$t_h(\text{H})$ $t_h(\text{L})$	Hold time nAx to $\overline{\text{EAB}}$ , nBx to $\overline{\text{EBA}}$	3	1.0 0.5	0.3 -0.2	1.0 0.5	ns
$t_w(\text{L})$	Latch enable pulse width, Low	3	4.0	3.1	4.0	ns

# Dual octal latched transceivers with dual enable (3-State)

MB2543

## AC WAVEFORMS

$V_M = 1.5V$ ,  $V_{IN} = GND$  to  $3.0V$

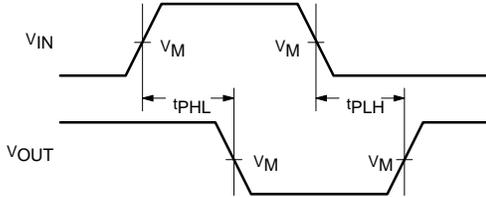

Waveform 1. Propagation Delay For Inverting Output

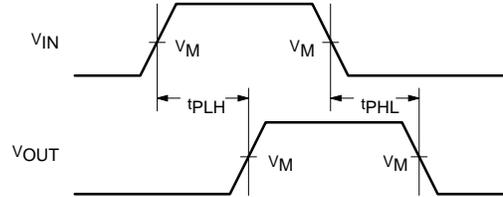

Waveform 2. Propagation Delay For Non-Inverting Output

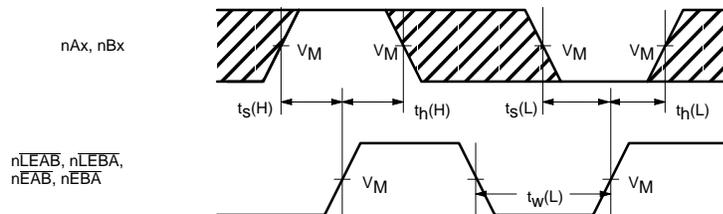

Waveform 3. Data Setup and Hold Times and Latch Enable Pulse Width

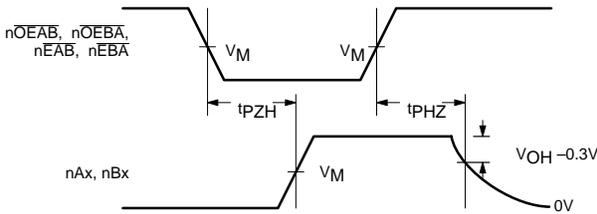

Waveform 4. 3-State Output Enable Time to High Level and Output Disable Time from High Level

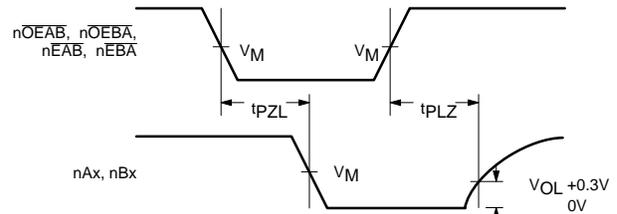

Waveform 5. 3-State Output Enable Time to Low Level and Output Disable Time from Low Level

NOTE: The shaded areas indicate when the input is permitted to change for predictable output performance.

# Dual octal latched transceivers with dual enable (3-State)

MB2543

## TEST CIRCUIT AND WAVEFORMS

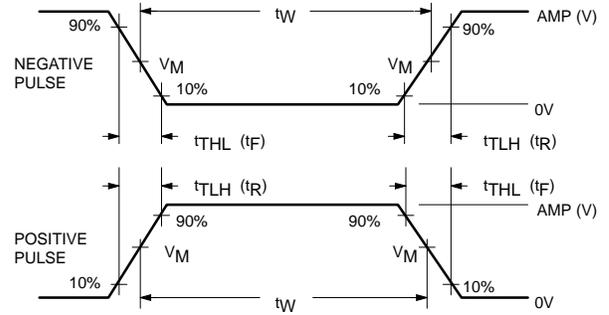
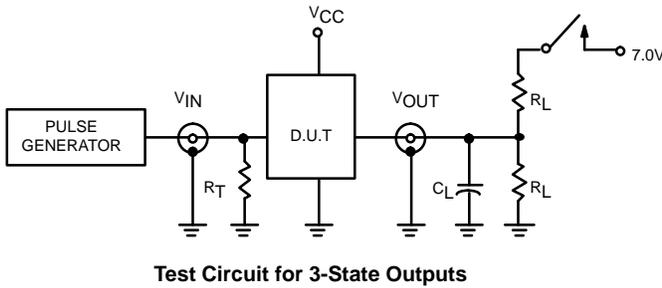

VM = 1.5V  
Input Pulse Definition

### SWITCH POSITION

TEST	SWITCH
tPLZ	closed
tPZL	closed
All other	open

### DEFINITIONS

RL = Load resistor; see AC CHARACTERISTICS for value.

CL = Load capacitance includes jig and probe capacitance; see AC CHARACTERISTICS for value.

RT = Termination resistance should be equal to ZOUT of pulse generators.

FAMILY	INPUT PULSE REQUIREMENTS				
	Amplitude	Rep. Rate	tw	tR	tF
MB	3.0V	1MHz	500ns	2.5ns	2.5ns

# Dual octal latched transceivers with dual enable (3-State)

MB2543

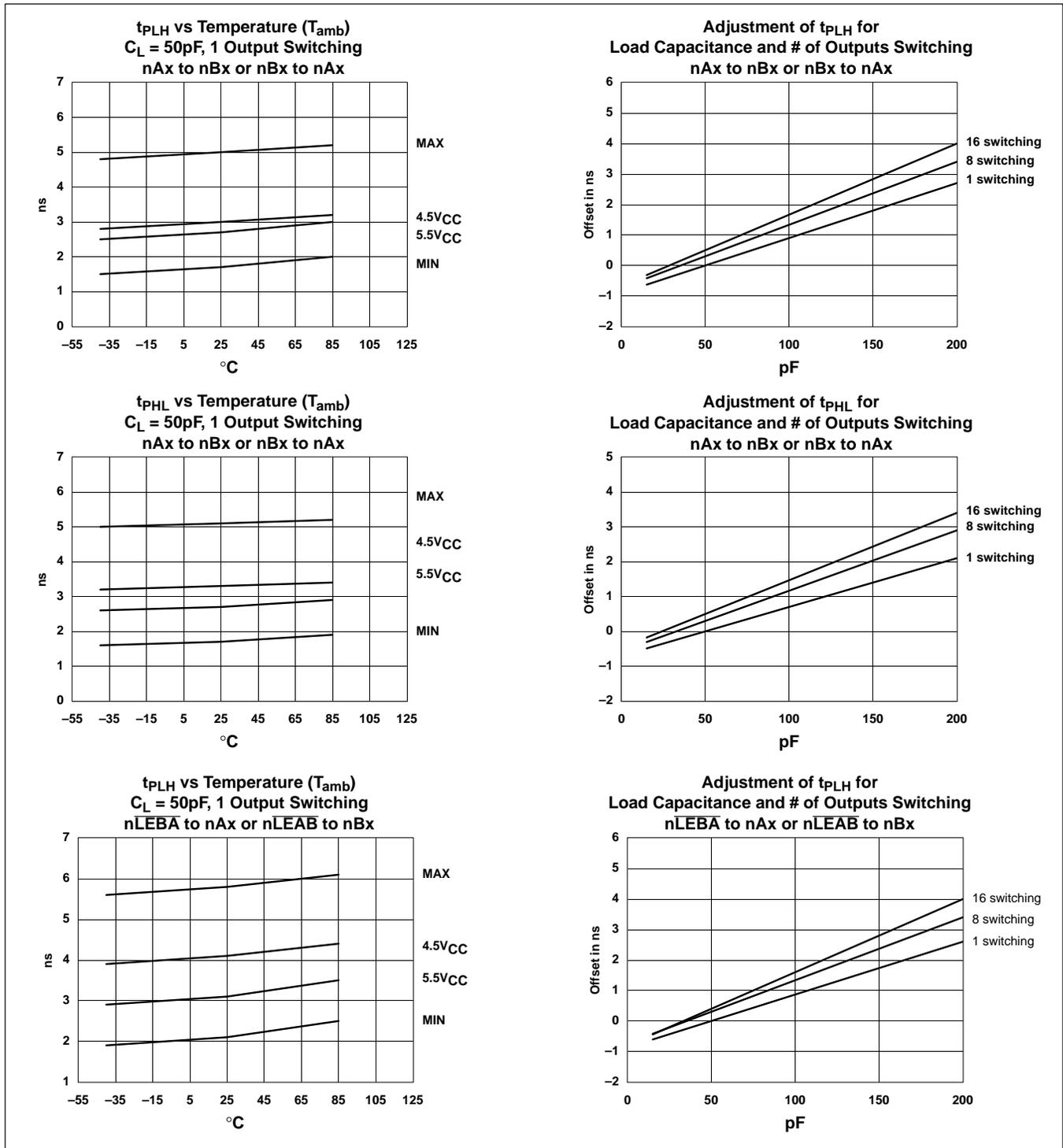

# Dual octal latched transceivers with dual enable (3-State)

MB2543

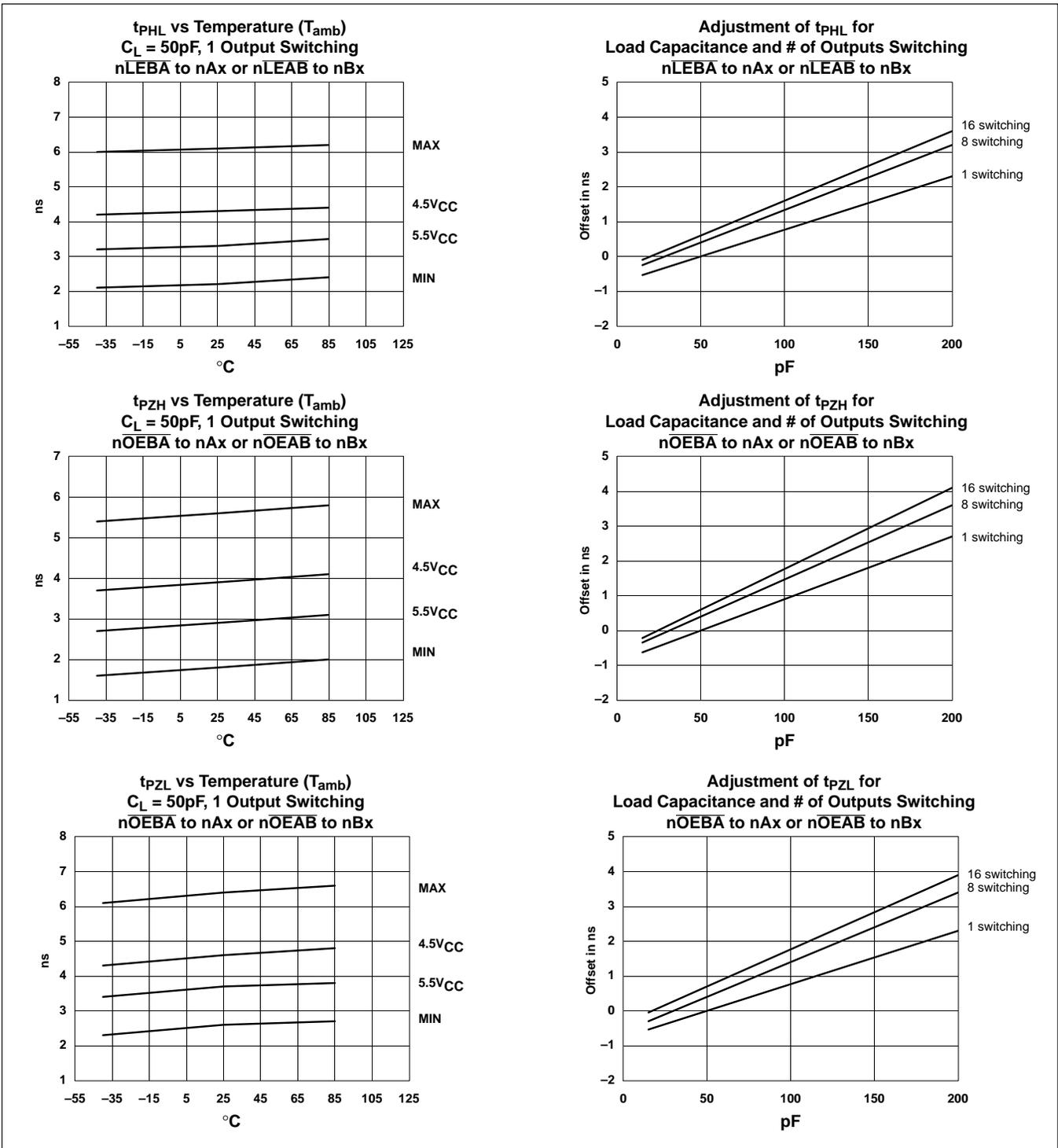

# Dual octal latched transceivers with dual enable (3-State)

MB2543

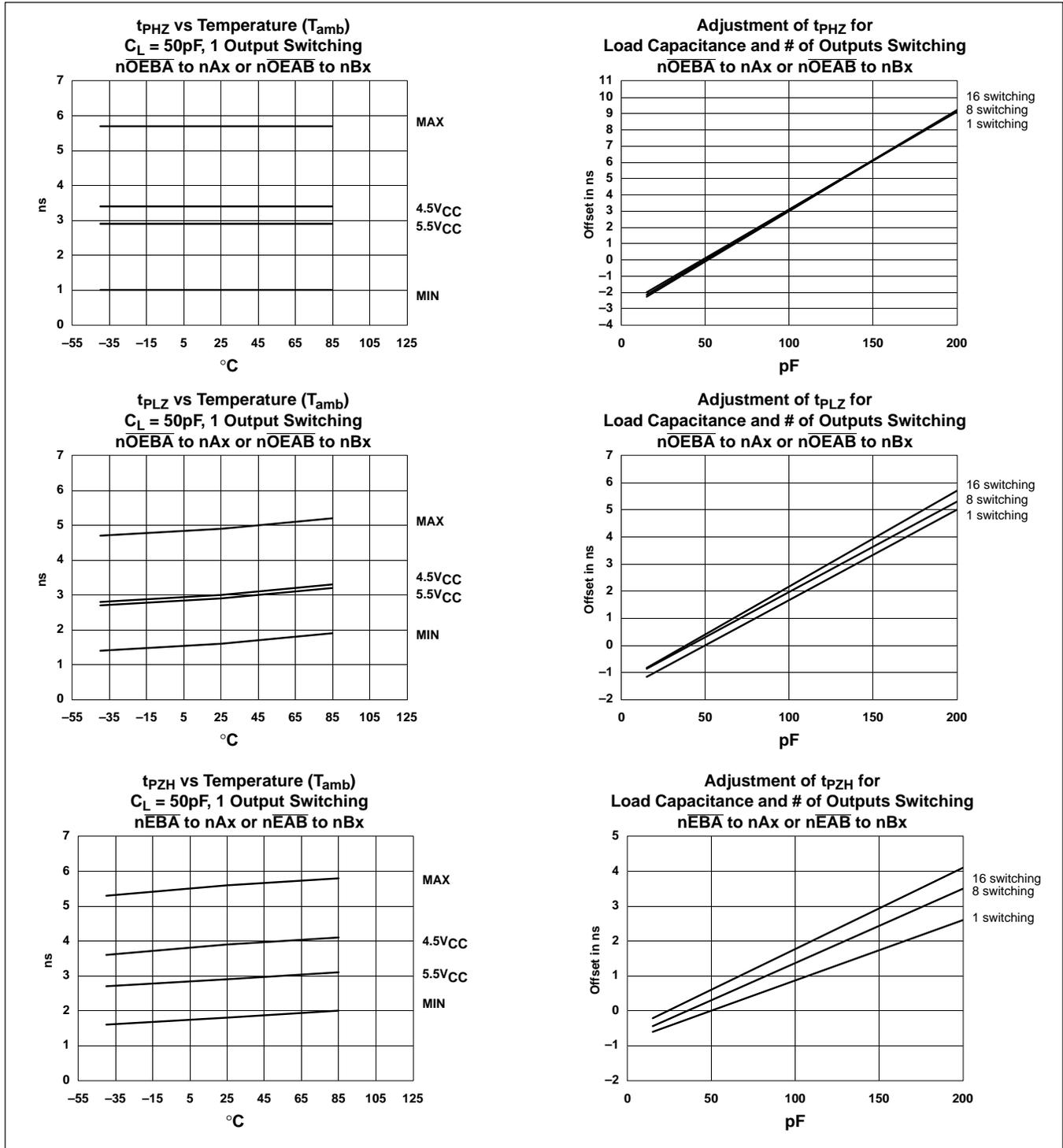

# Dual octal latched transceivers with dual enable (3-State)

MB2543

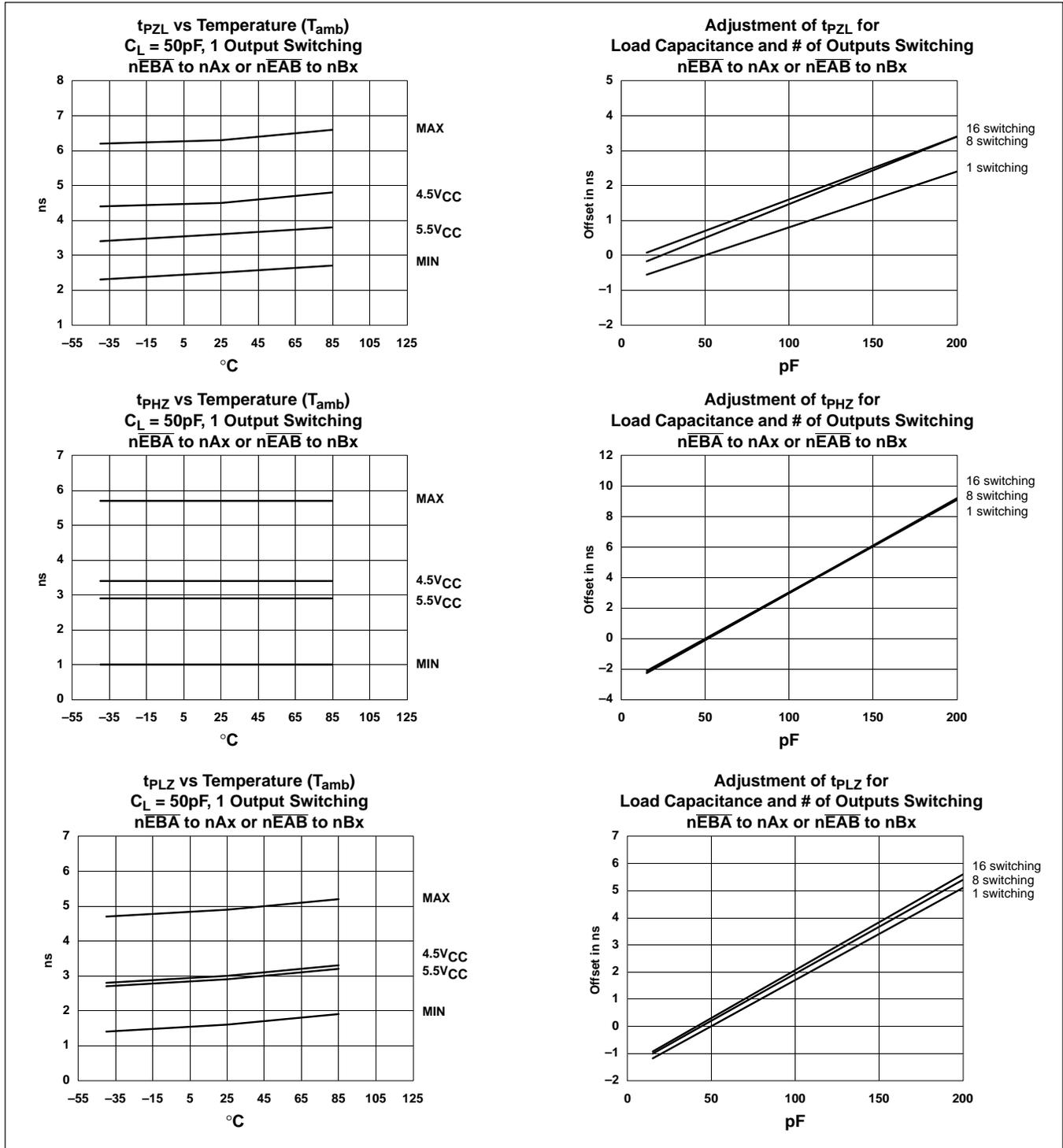

# Dual octal latched transceivers with dual enable (3-State)

MB2543

