

**Features:**

- ✓ Small size, minimal footprint – SMT/SIP package
- ✓ 15A Output Current (all voltages)
- ✓ High Efficiency: up to 96%
- ✓ High reliability
- ✓ RoHS Compliant
- ✓ Cost efficient open frame design
- ✓ Output voltage programmable by an external resistor
- ✓ Monotonic Start with Pre-Bias
- ✓ Over-current and Over-temperature protection

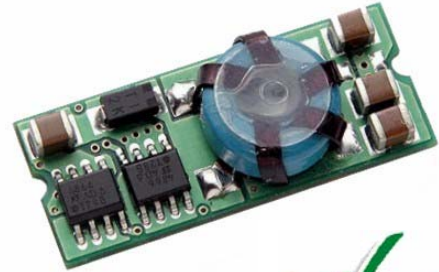

Output				Input			Efficiency		
Vout (V)	Iout (A)	PARD (mVp-p)		Regulation Max		Vin Nom. (V)	Range (V)	Iin Max (A)	Full Load
		Typ.	Max.	Line	Load				
1	15	28	50	+/-0.2%	+/-0.4%	5	3-5.5	5.81	82%
1.2	15	28	50	+/-0.2%	+/-0.4%	5	3-5.5	6.89	84%
1.5	15	28	50	+/-0.2%	+/-0.4%	5	3-5.5	8.42	87%
1.8	15	28	50	+/-0.2%	+/-0.4%	5	3-5.5	9.89	88%
2	15	28	50	+/-0.2%	+/-0.4%	5	3-5.5	10.86	89%
2.5	15	28	50	+/-0.2%	+/-0.4%	5	3-5.5	11.5	92%
3.3	15	28	50	+/-0.2%	+/-0.4%	5	4.5-5.5	11.45	94%

Input Characteristics	Notes & Conditions	Min	Typ.	Max	Units
Input Voltage Operating Range		3.0	5	5.5	Vdc
Input Reflected Ripple Current			100		mA p-p
Inrush Current Transient				0.4	A <sup>2</sup> s
Input Filter Type (external)			100		μF
Input Turn ON Threshold			2.8		V
Input Turn OFF Threshold			2.7		V
ON Control	Open or 0 to +0.4V				
OFF Control	+2.8V to Vin (<3mA)				

Output Characteristics	Notes & Conditions	Min	Typ.	Max	Units
Vout Accuracy	50% load	-1.5		+1.5	%
Output Loading		0		15	A
Output Ripple & Noise @ 20Mhz Bandwidth.				30	mV
Maximum Capacitive Load	Low ESR			8000	μF
Vout Trim Range (Nom)		0.9		3.3	V
Total Accuracy	Over line/load temperature		<3%		
Current Limit		19.5	23	27	A
Output Line Regulation		-0.2		+0.2	%
Output Load Regulation		-0.5		+0.5	%
Turn-on Overshoot				1	%
SC Protection Technique	Hiccup with auto recovery				
Pre-bias Start-up at output	Unit starts monotonically with pre-bias				

Dynamic Characteristics	Notes & Conditions	Min	Typ.	Max	Units
Load Transient	50% step, 2.5A/μs			100	mV
	Settling Time			100	μs
Frequency			300khz		
Start-Up Time	Vin to Vout and On/Off to Vout Vout rise to monotonic		<20		ms

General Specifications	Notes & Conditions	Min	Typ.	Max	Units
MTBF	Calculated (MIL-HDBK-217F)	1.4			x10 <sup>6</sup> Hrs
	Demonstrated @ 90% Confidence Level	1			x10 <sup>6</sup> Hrs
Thermal Protection	Hotspot		110	120	°C
Operating Temperature	Without derating	-40		60	°C
Dimensions	2"Lx0.34"Wx0.5"H (50.8x8.64x12.7mm)				
Pin Dimensions	0.03" (0.76mm)				
Pin Material	Round copper with tin-lead plated over nickel underplate				
Weight	0.3 ounces (8.5g)				
Flammability Rating	UL94V-0				

Standards Compliance
CSA C22.2, No.60950/UL 60950, Third Edition (2000), File UL E165113

### Thermal Considerations

The power module operates in a variety of thermal environments; however, sufficient cooling should be provided to help ensure reliable operation of the unit.

The thermal data presented is based on measurements taken at various airflows. Note that airflow is parallel to the long axis of the module as shown in Figure 1 and derating applies accordingly.

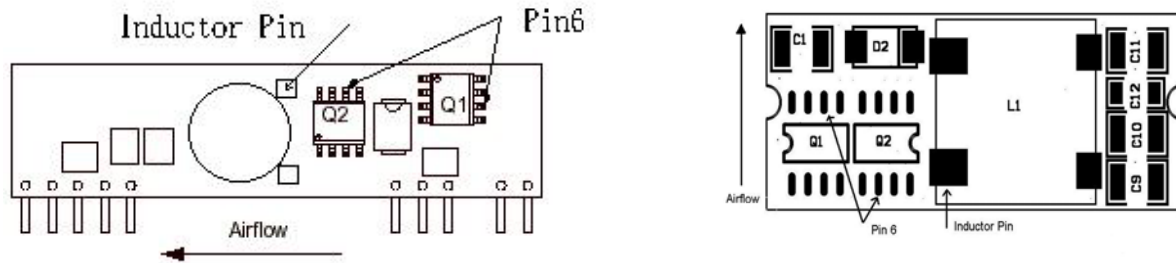

Figure 1. Thermal Tests Set-Up.

The temperature at either location should not exceed 110°C. The output power of the module should not exceed the rated power for the module ( $V_{o,set} \times I_{o,max}$ ).

### Convection Requirements for Cooling

To predict the approximate cooling needed for the module, refer to the Power Derating Curves in Figures 2-15.

These derating curves are approximations of the ambient temperature and airflow required to keep the power module temperature below its maximum rating. Once the module is assembled in the actual system, the module's temperature should be verified.

**TYPICAL DERATING CURVES SIP/SMT VERSION**

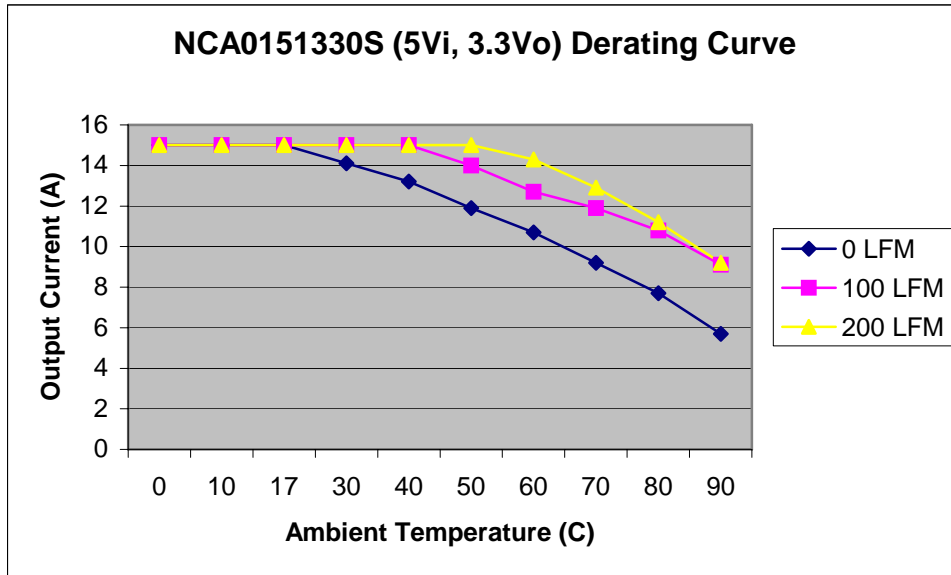

Fig. 2. SMT Power Derating vs Output Current for 5Vin 3.3V Out.

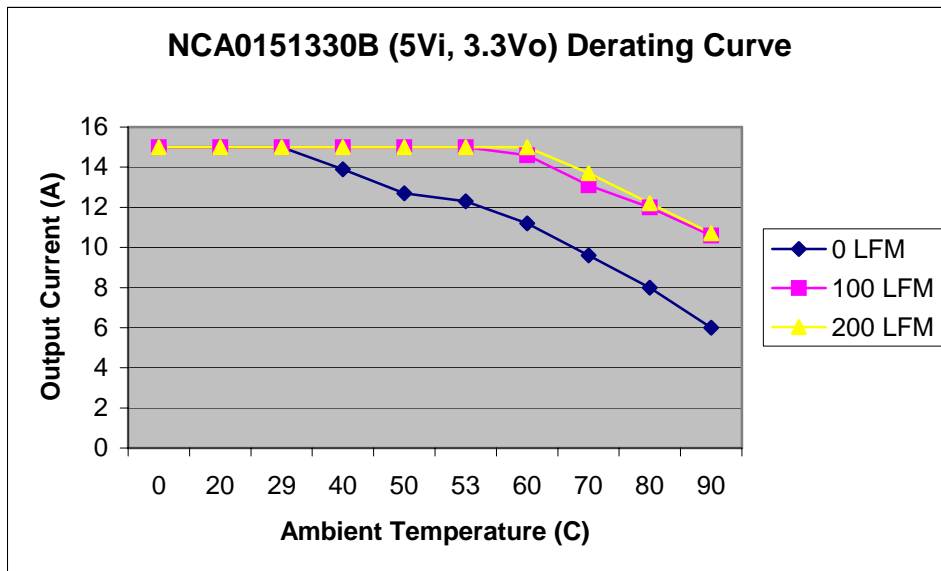

Fig. 3. SIP Power Derating vs Output Current for 5Vin 3.3V Out.

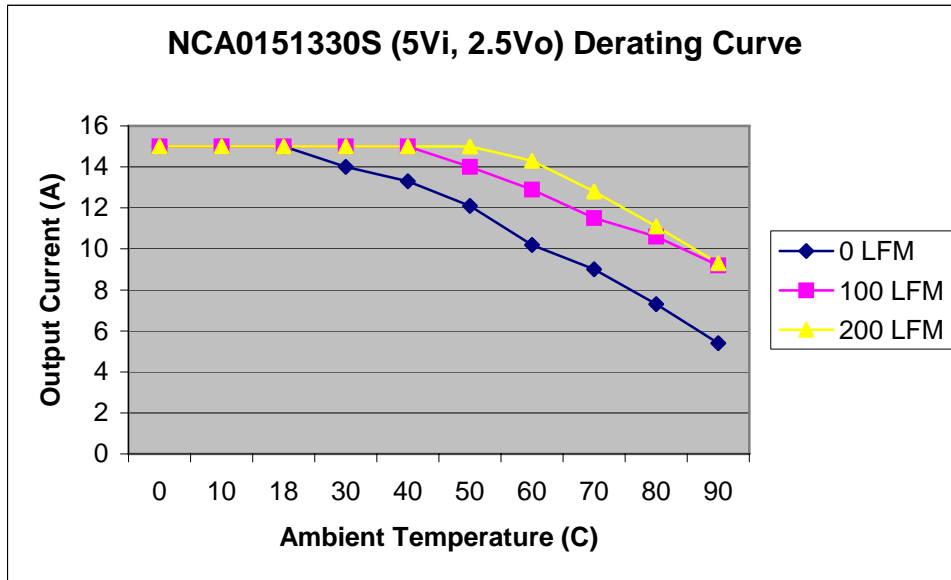

Fig 4. SMT Power Derating vs Output Current for 5Vin 2.5V Out.

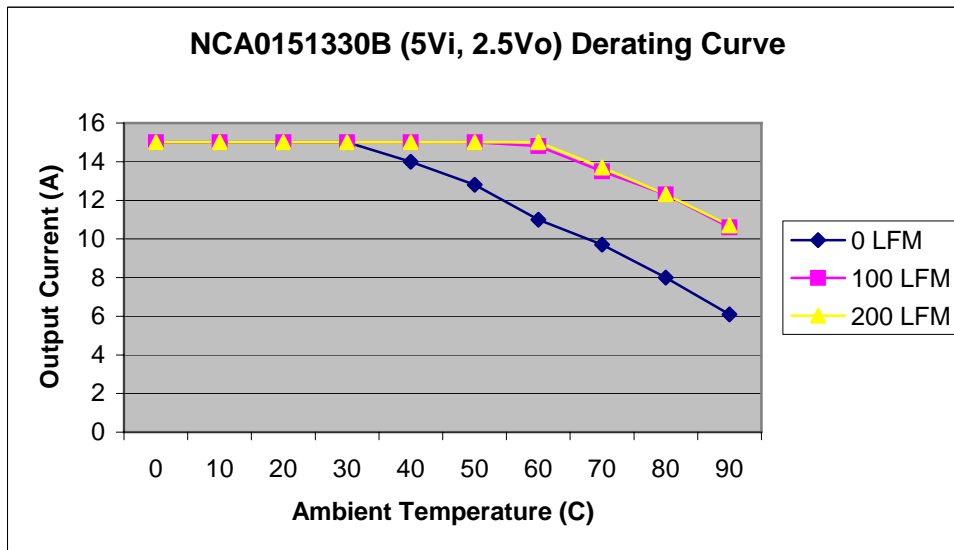

Fig 5. SIP Power Derating vs Output Current for 5Vin 2.5V Out.

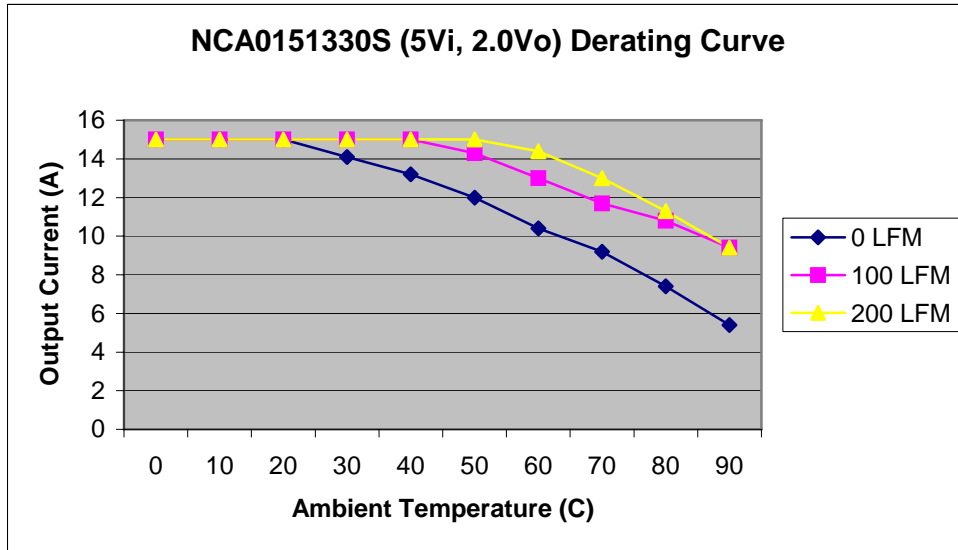

Fig 6. SMT Power Derating vs Output Current for 5Vin 2.0V Out.

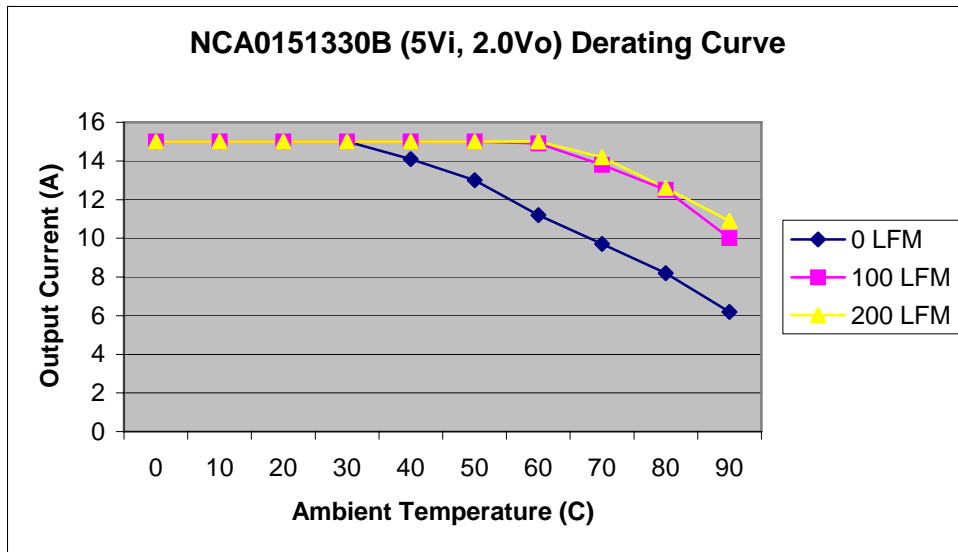

Fig 7. SIP Power Derating vs Output Current for 5Vin 2.0V Out.

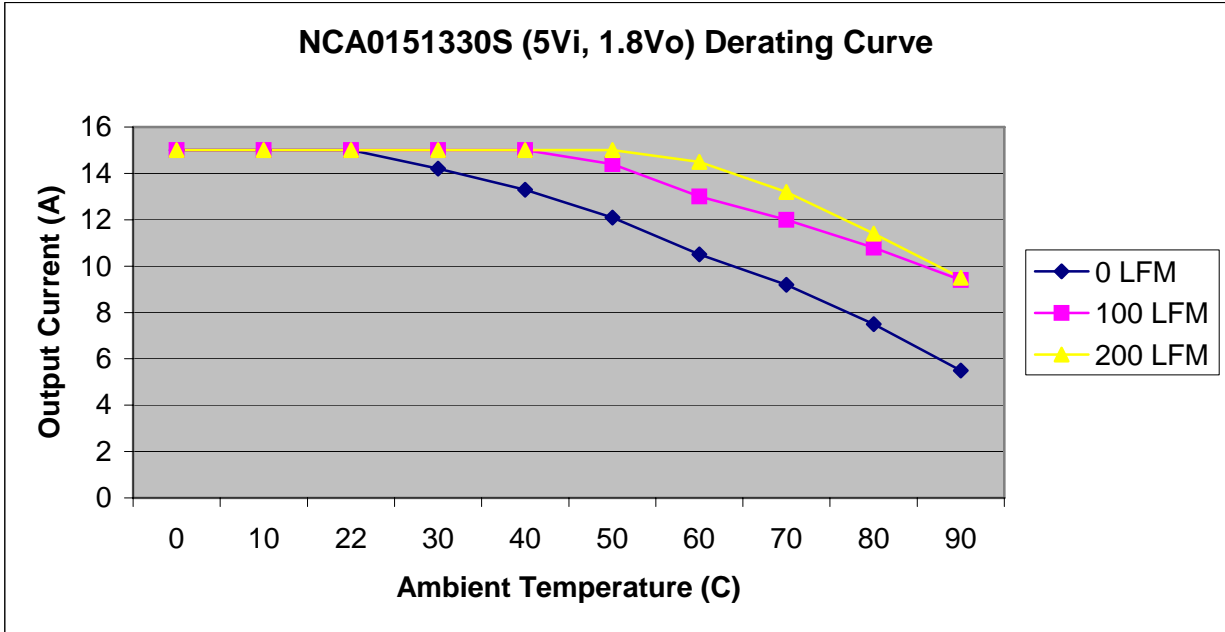

Fig 8. SMT Power Derating vs Output Current for 5Vin 1.8V Out.

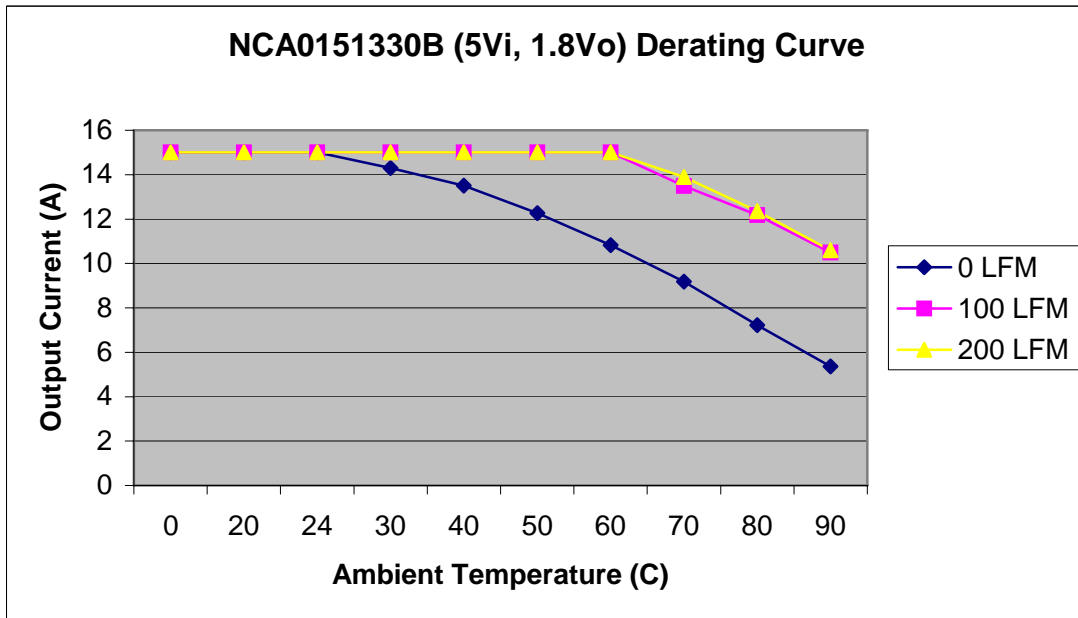

Fig 9. SIP Power Derating vs Output Current for 5Vin 1.8V Out.

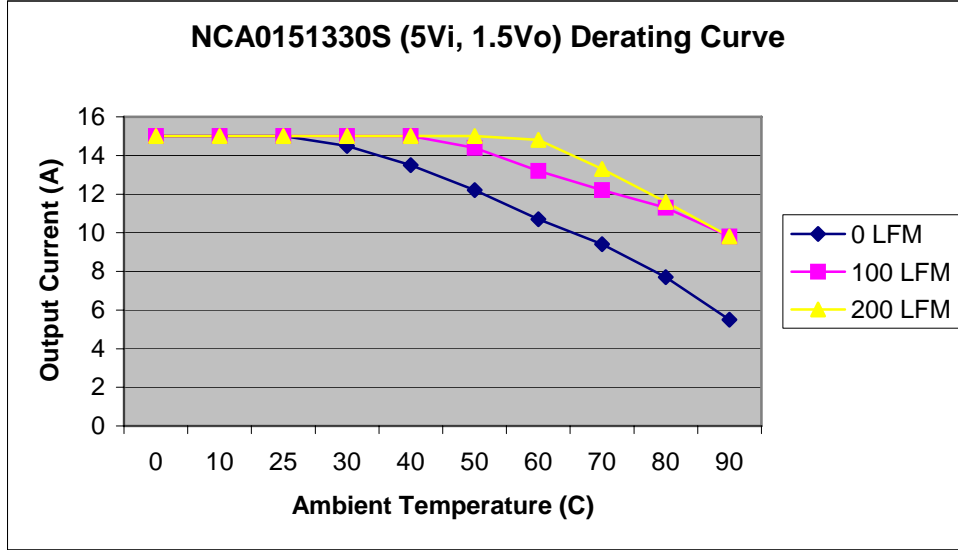

Fig 10. SMT Power Derating vs Output Current for 5V<sub>in</sub> 1.5V Out.

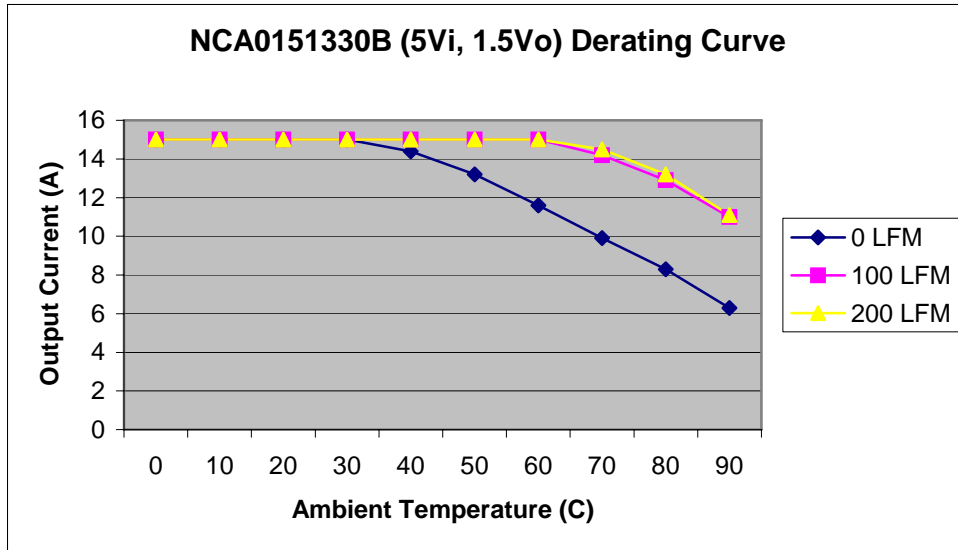

Fig 11. SIP Power Derating vs Output Current for 5V<sub>in</sub> 1.5V Out.



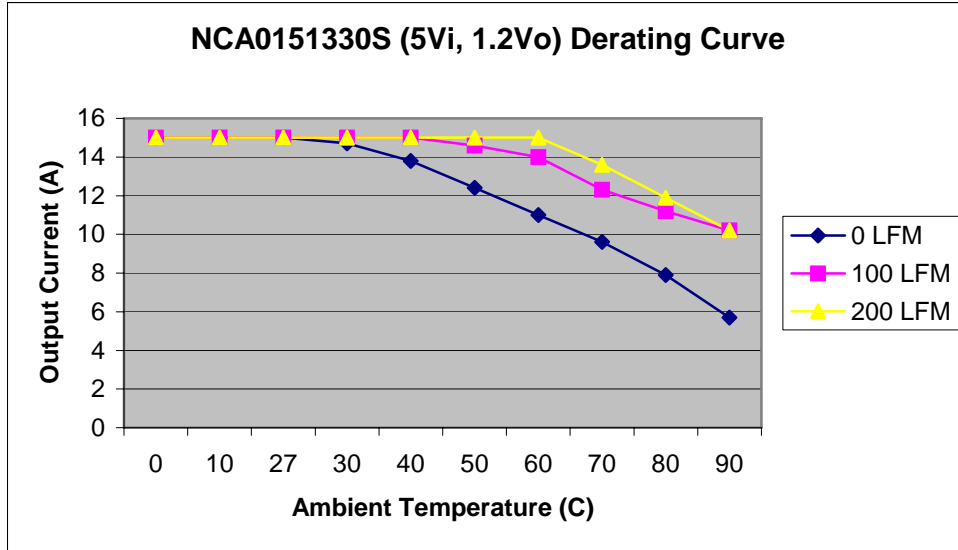

Fig 12. SMT Power Derating vs Output Current for 5Vin 1.2V Out.

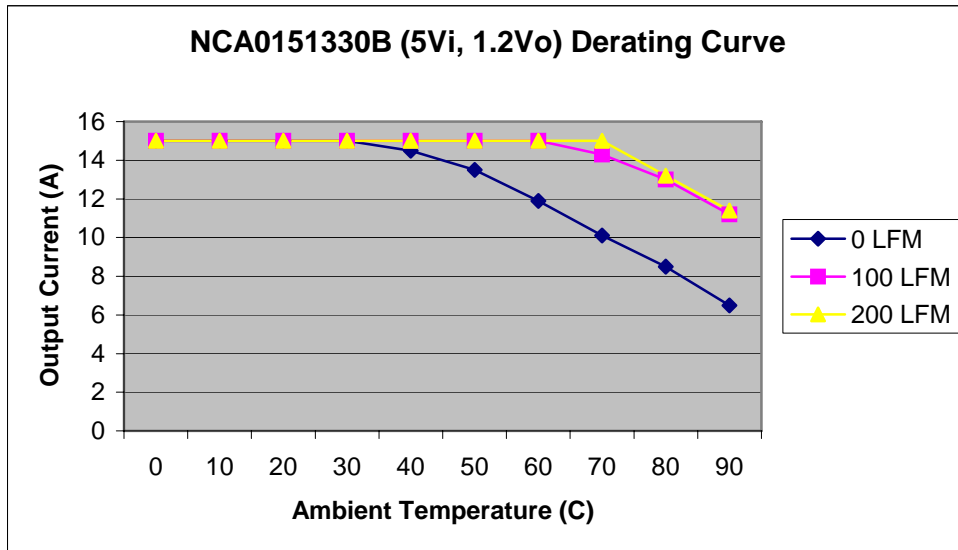

Fig 13. SIP Power Derating vs Output Current for 5Vin 1.2V Out.

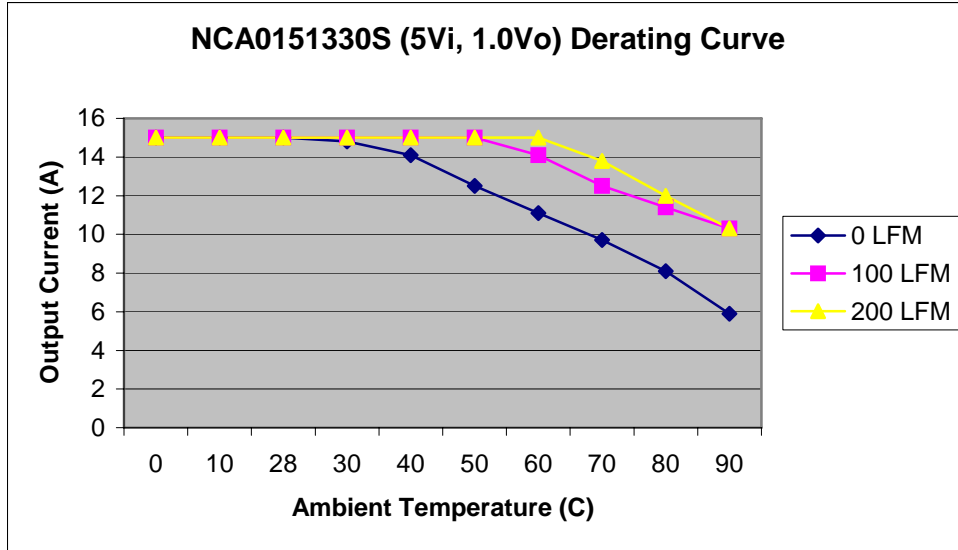

Fig. 14. SMT Power Derating vs Output Current for 5Vin 1.0V Out.

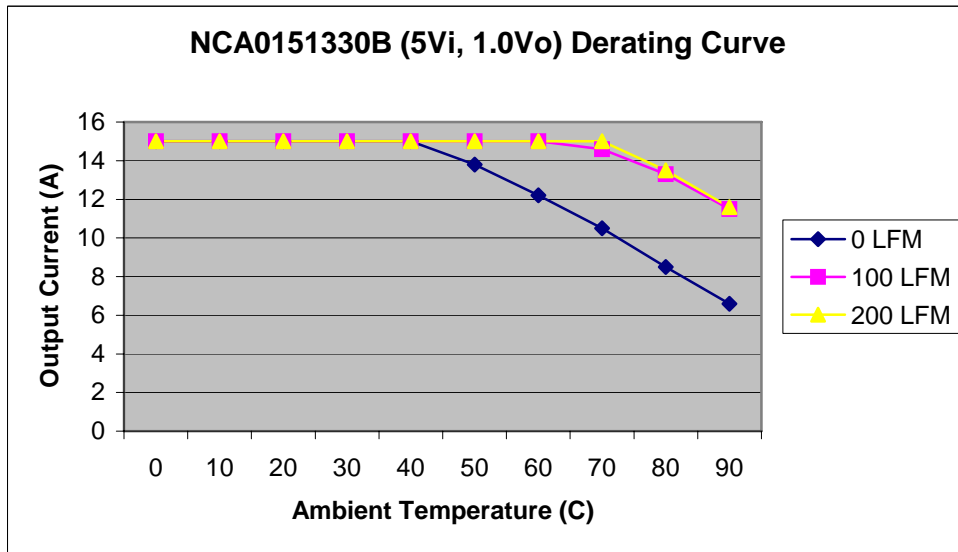

Fig 15. SIP Power Derating vs Output Current for 5Vin 1.0V Out.

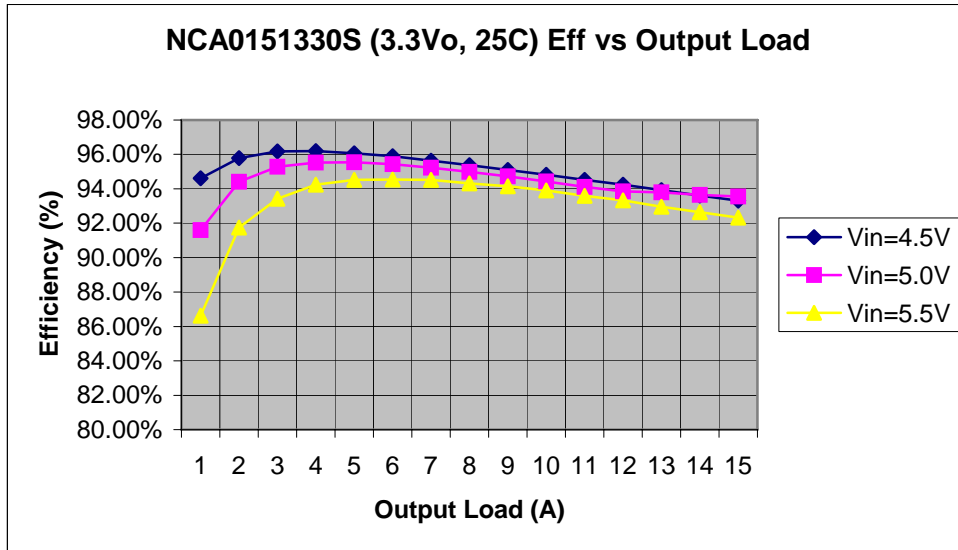

Fig 16. SMT Efficiency Curves for Vout=3.3V (25C)

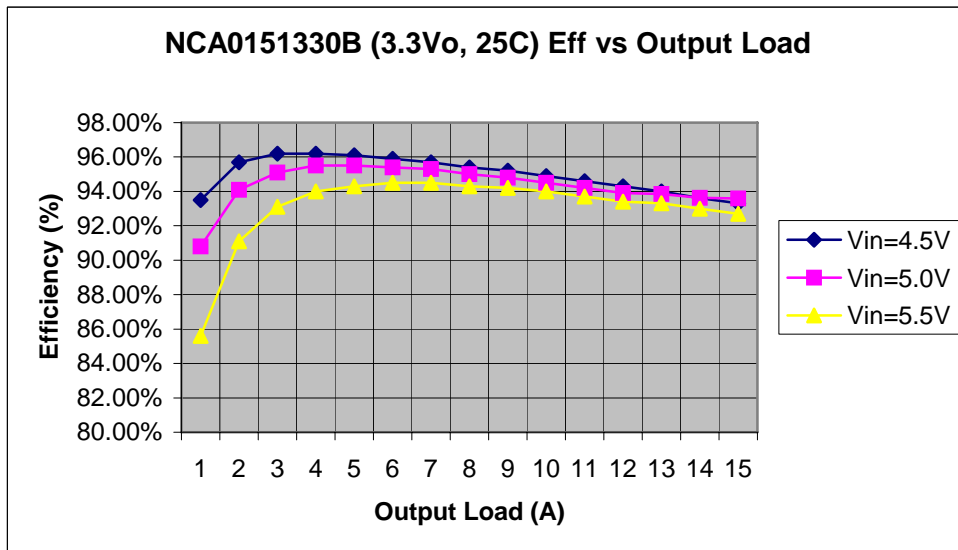

Fig 17. SIP Efficiency Curves for Vout=3.3V (25C)

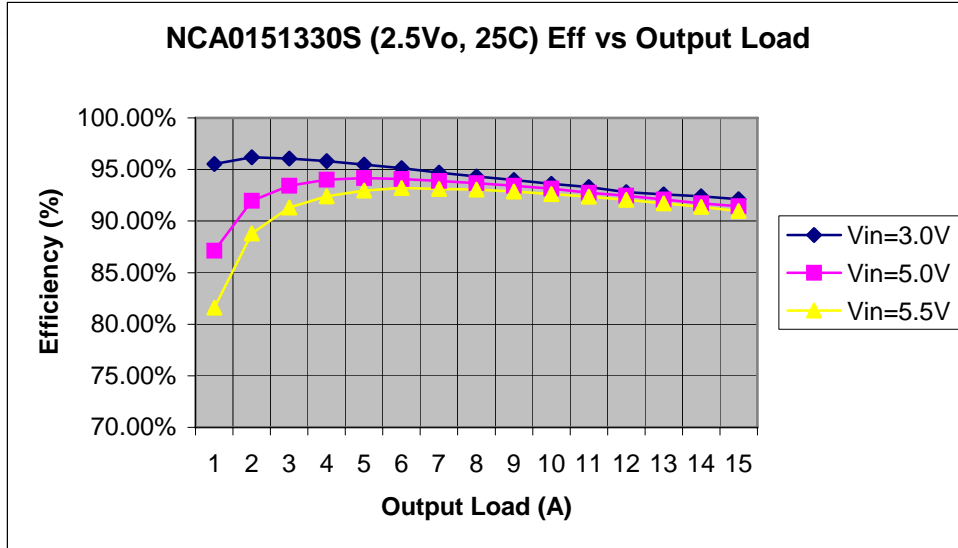

Fig 18. SMT Efficiency Curves for Vout=2.5V (25C)

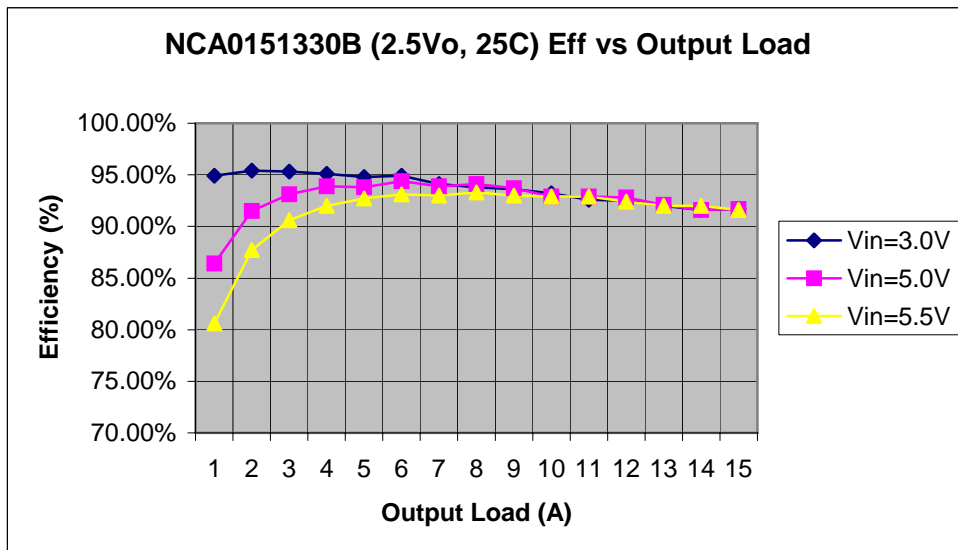

Fig 19. SIP Efficiency Curves for Vout=2.5V (25C)

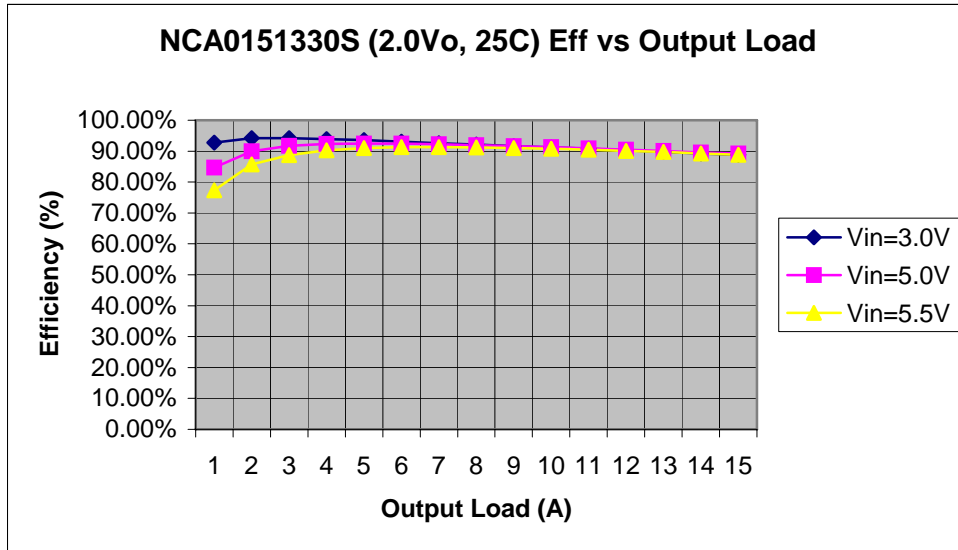

Fig 20. SMT Efficiency Curves for Vout=2.0V (25C)

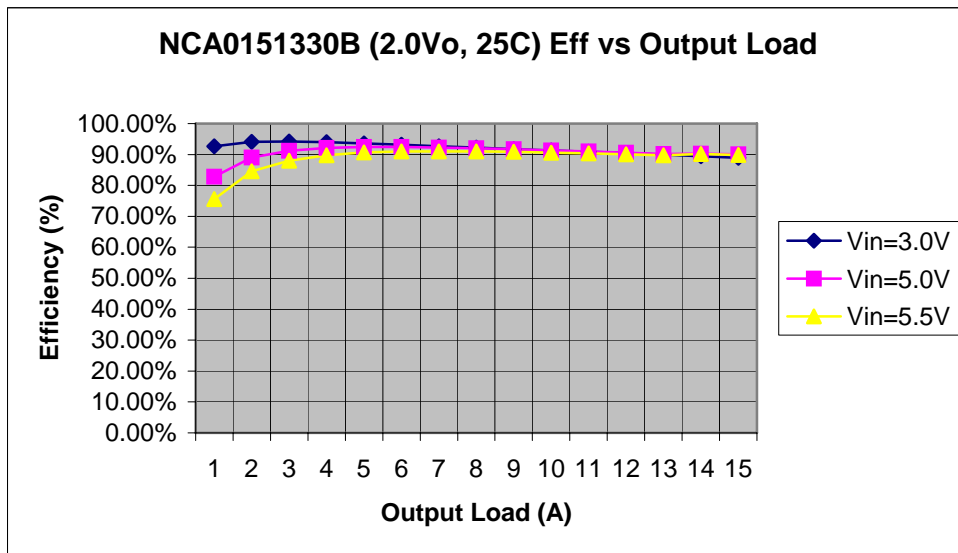

Fig 21. SIP Efficiency Curves for Vout=2.0V (25C)

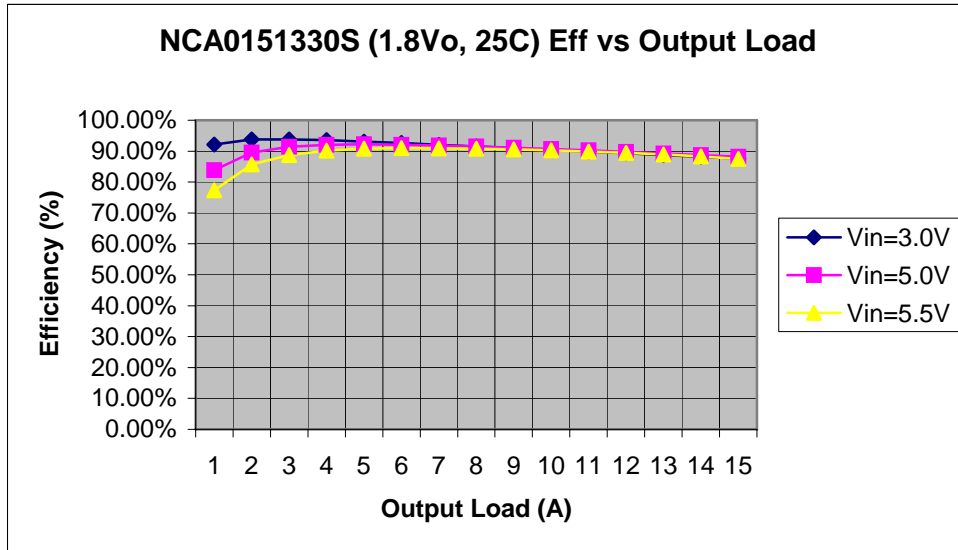

Fig 22. SMT Efficiency Curves for Vout=1.8V (25C)

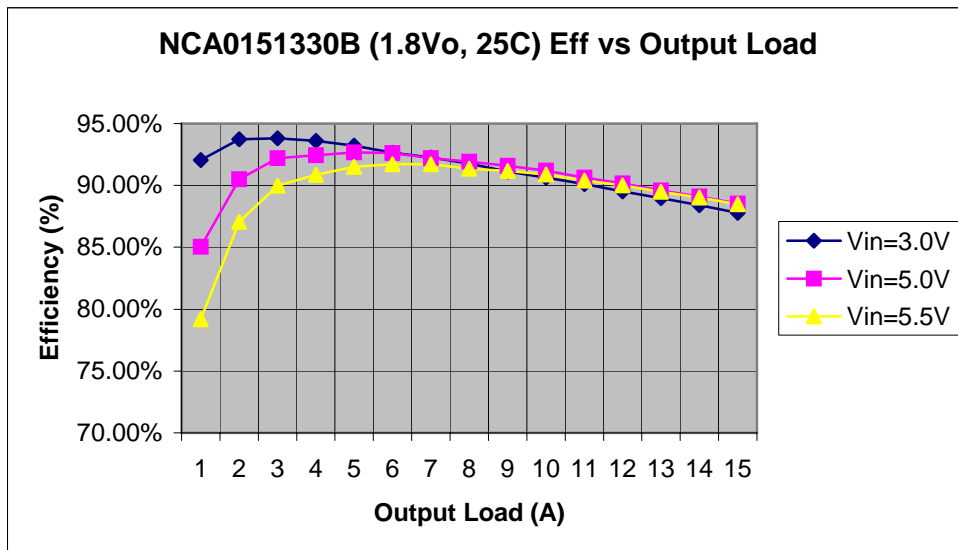

Fig 23. SIP Efficiency Curves for Vout=1.8V (25C)

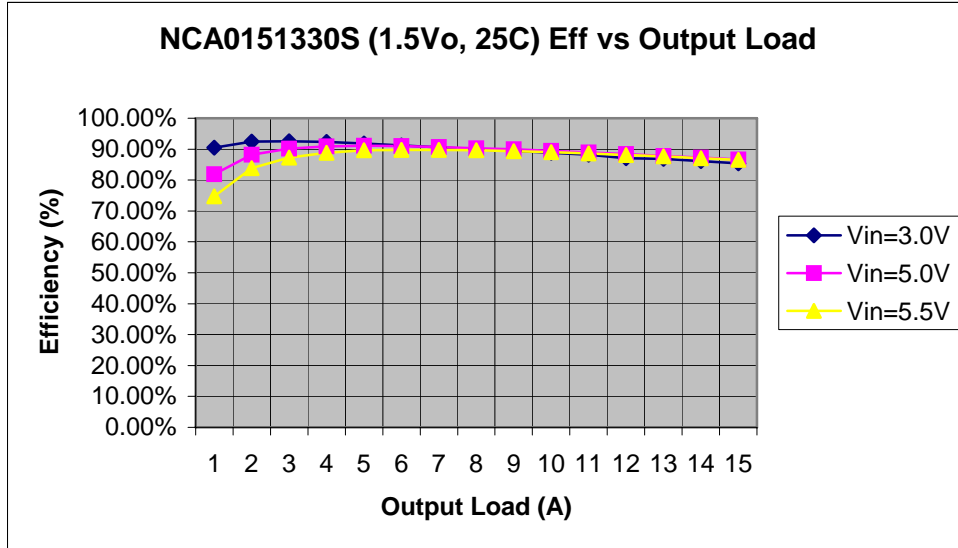

Fig 24. SMT Efficiency Curves for Vout=1.5V (25C)

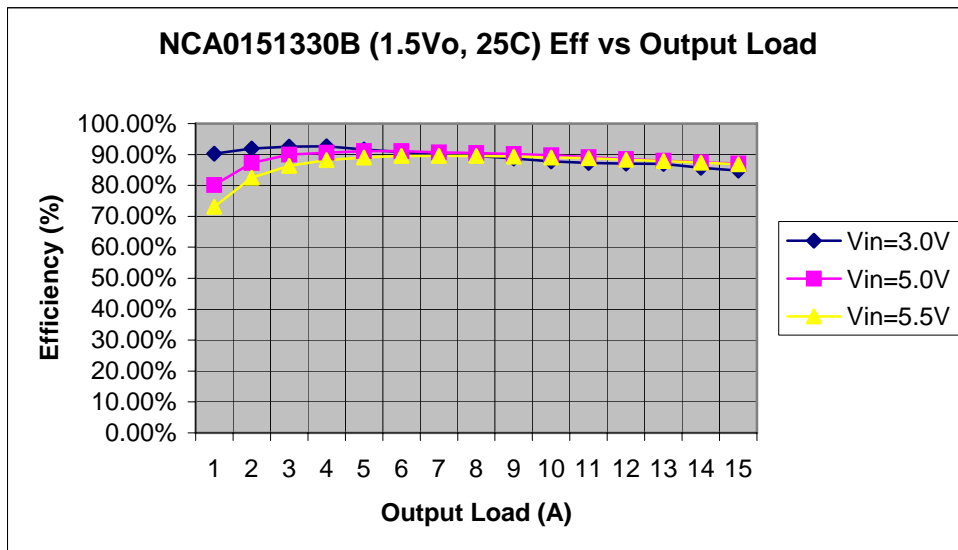

Fig 25. SIP Efficiency Curves for Vout=1.5V (25C)

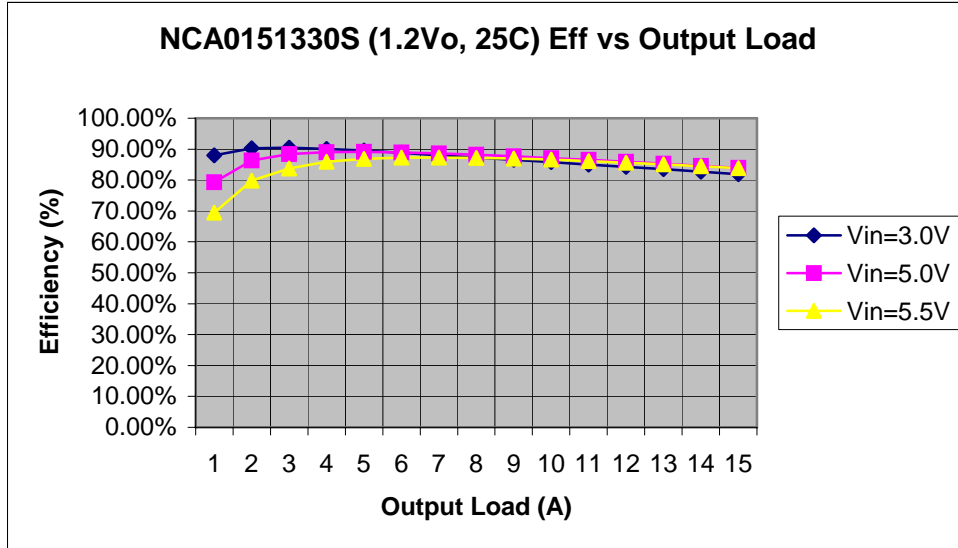

Fig 26. SMT Efficiency Curves for Vout=1.2V (25C)

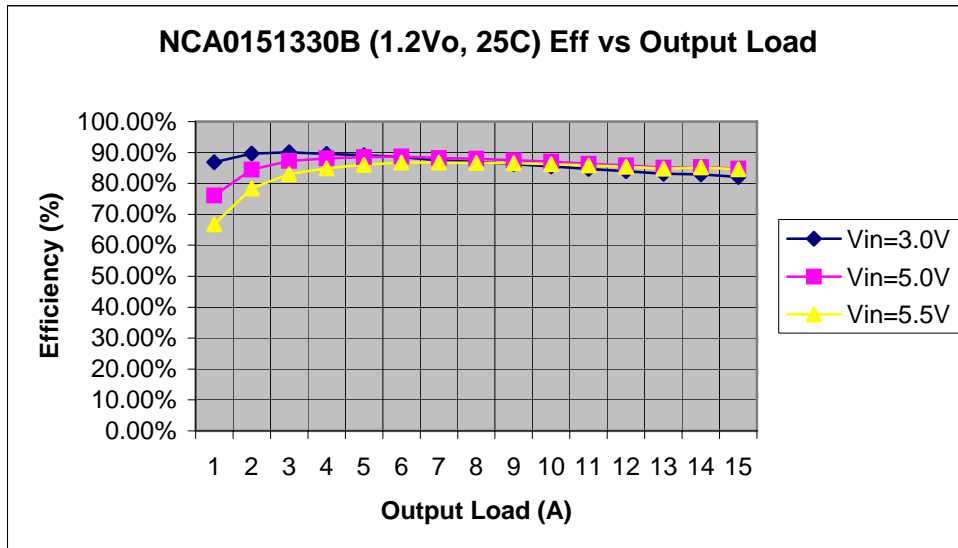

Fig 27. SIP Efficiency Curves for Vout=1.2V (25C)



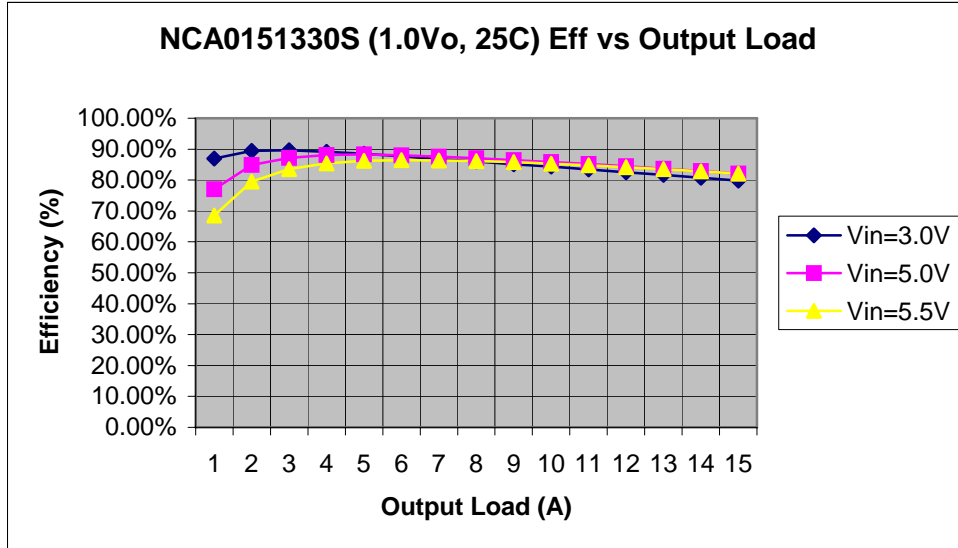

Fig 28. SMT Efficiency Curves for Vout=1.0V (25C)

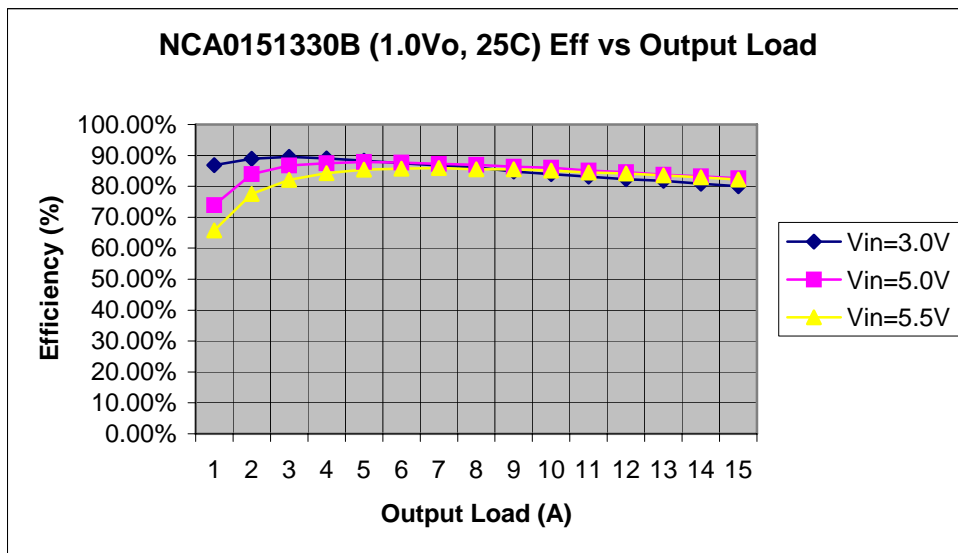
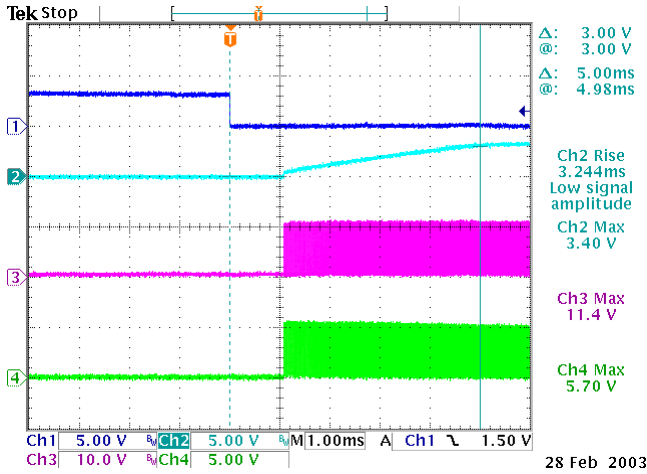

Fig 29. SIP Efficiency Curves for Vout=1.0V (25C)

**Typical Start Up**

- Ch 1. Enable
- Ch2. Vout, Full load.
- Ch3. Q1-Vgs
- Ch4. Q2-Vgs



**Typical Start Up with pre-bias**

- Ch1 : Enable
- Ch2 : Vout
- Ch3 : Output current at No Load.

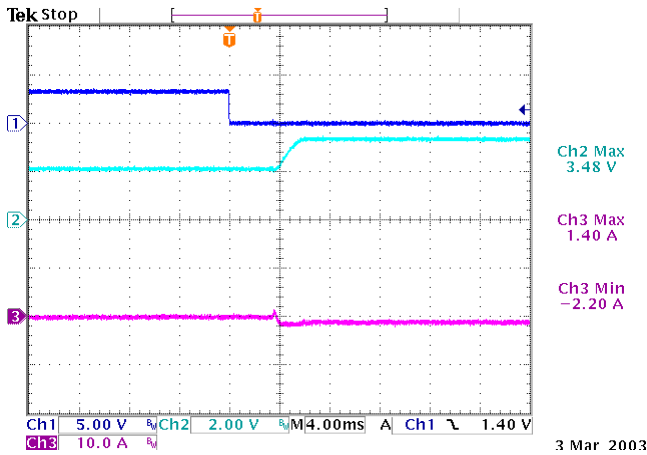

**Typical Output Noise and Ripple**

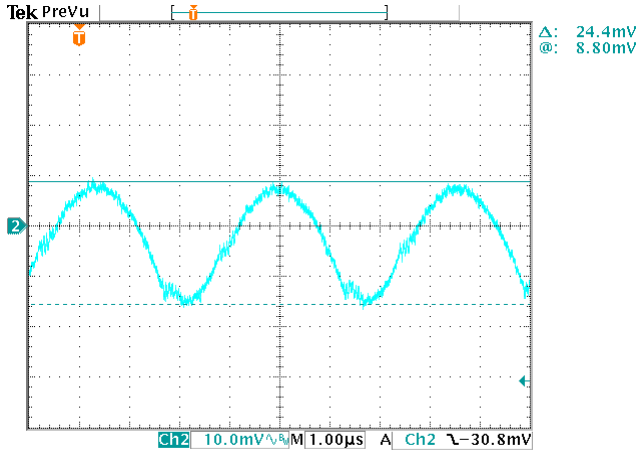

25 Feb 2003

**Output Voltage Set point adjustment.**

The following relationship establish the calculation of external resistors:

$$R_{adj} = \frac{21070}{V_o - 0.7525} - 5110$$

For Vout setting an external resistor is connected between the TRIM and Ground Pin.

Resistor values for different output voltages are calculated as given in the table:

Vo, set (Volts)	RAdj (KΩ)
3.3	3.160
2.5	6.947
2.0	11.780
1.8	15.004
1.5	23.077
1.2	41.973
1.0	80.02
0.9	137.74
0.75	Open

**Remote Sense:**

All C&D SMT/SIP power modules offer an option for remote sense. The remote sense compensates for any distribution drops to accurately control voltage at the point of load. The voltage between the sense pin to Vout pin should not exceed 0.5V.

**SMT Lead free Reflow profile**

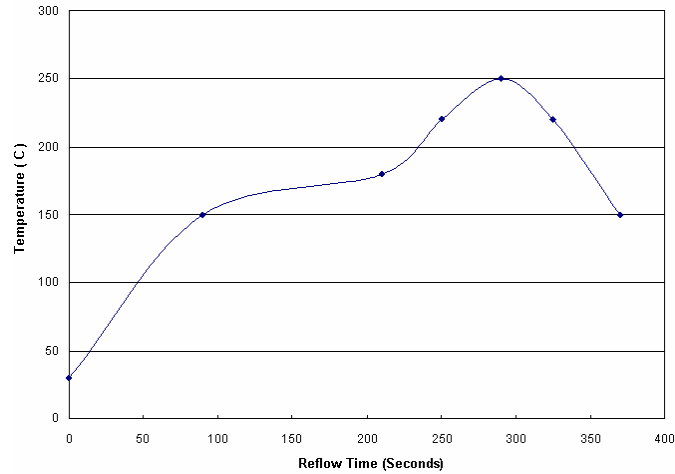

1. Ramp up rate during preheat : 1.33 °C/Sec ( From 30°C to 150°C )
2. Soaking temperature : 0.29 °C/Sec ( From 150°C to 180°C )
3. Ramp up rate during reflow : 0.8 °C/Sec ( From 220°C to 250°C )
4. Peak temperature : 250°C, above 220°C 40 to 70 Seconds
5. Ramp up rate during cooling : -1.56 °C/Sec ( From 220°C to 150°C )

**Mechanical and pinning Information.**

Given below is the outline drawing showing physical dimensions of the SIP & SMT package.

The external dimensions for SMT package are 33.00mm X 13.46mm X 9.30mm.

**BOTTOM VIEW OF BOARD**

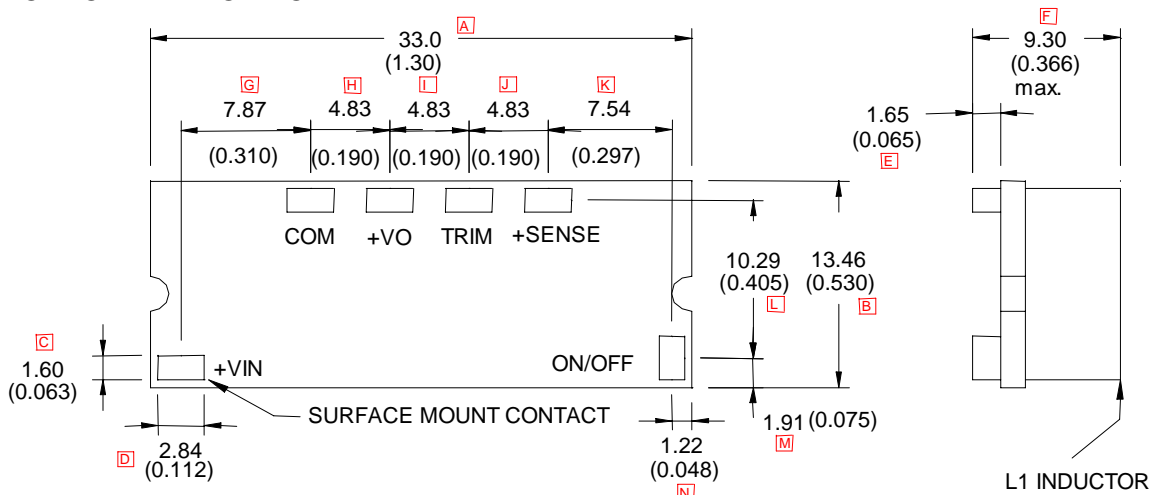

Whereas, the external dimensions of the SIP version are 50.8mm X 12.7mm X 8.3mm.

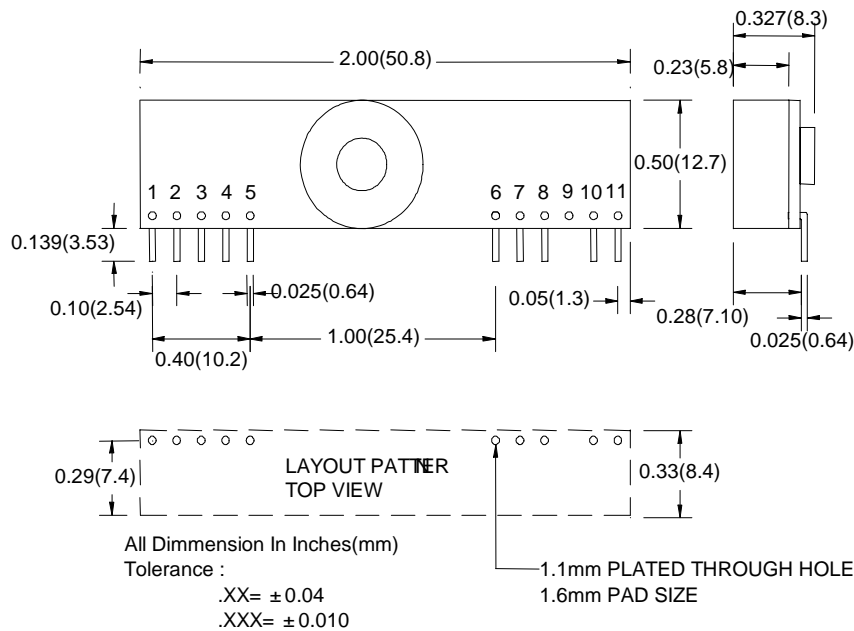

PIN CONNECTION	
Pin	FUNCTION
1	+Output
2	+Output
3	+Sense
4	+Output
5	Common
6	Common
7	+V Input
8	+V Input
9	No Pin
10	Trim
11	On/Off Control

**Safety Considerations**

The NCA series of converters are certified to IEC/EN/CSA/UL 60950. If this product is built into information technology equipment, the installation must comply with the above standard. An external input fuse of less than 50 Amps (5A to 30A recommended), must be used to meet the above requirements. The output of the converter [Vo(+)/Vo(-)] is considered to remain within SELV limits when the input to the converter meets SELV or TNV-2 requirements. The converters and materials meet UL 94V-0 flammability ratings.

**Ordering Information**

Part Number	Vin	Vout	Iout	Enable Logic	Pin Length
NCA0151330B0C	3.0V - 5.5V	1.0V - 3.3V	15A	Negative	0.139"
NCA0151330S0C	3.0V - 5.5V	1.0V - 3.3V	15A	Negative	SMT
NCA0151331B0C	3.0V - 5.5V	1.0V - 3.3V	15A	Positive	0.139"
NCA0151331S0C	3.0V - 5.5V	1.0V - 3.3V	15A	Positive	SMT



**Label Information**

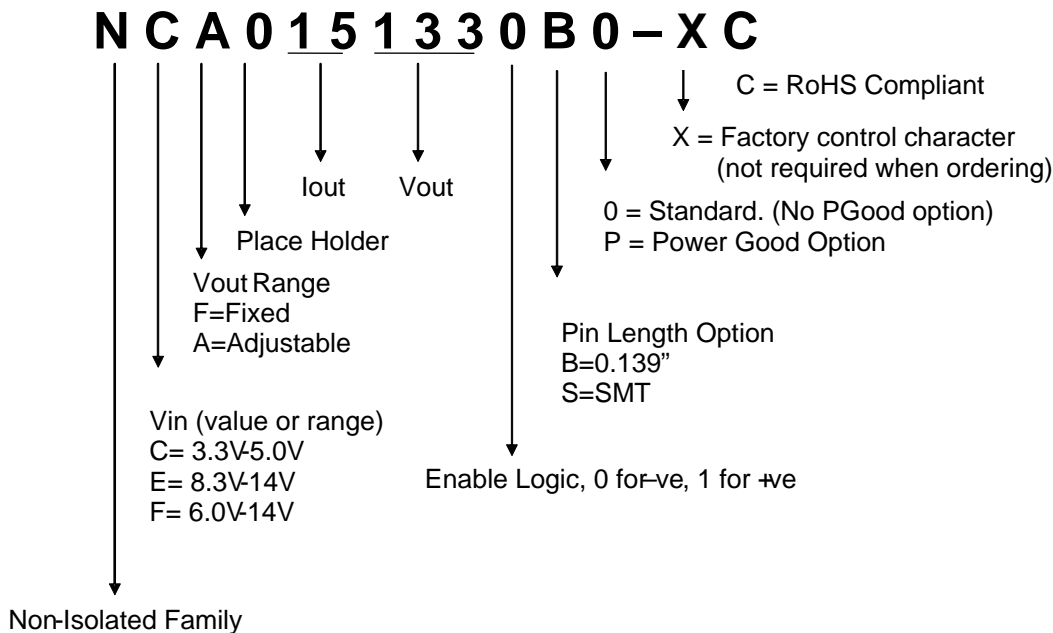

**RoHS Compliant**

The NCA015 series of converters is in compliance with the European Union Directive 2002/95/EC (RoHS) with respect to the following substances: lead (Pb), mercury (Hg), cadmium (Cd), hexavalent chromium, polybrominated biphenyls (PBB) or polybrominated diphenyl ethers (PBDE).

C&D Technologies, Inc. reserves the right to alter or improve the specification, internal design or manufacturing process at any time, without notice. Please check with your supplier or visit our website to ensure that you have the current and complete specification for your product before use.

© C&D Technologies, Inc. 2004

No part of this publication may be copied, transmitted, or stored in a retrieval system or reproduced in any way including, but not limited to, photography, photocopy, magnetic or other recording means, without prior written permission from C&D Technologies, Inc.

Instructions for use are available from: [www.cdtechno-cps.com](http://www.cdtechno-cps.com)