

## DIPLEXER FOR CABLE MODEM / DIGITAL SET-TOP BOX

### DESCRIPTION

The TOKO DIP1A Series of wirewound diplexers contain an integrated coaxial F-connector and are specifically designed for DOCSIS 2.0 broadband communication platforms including cable modems, digital set-top boxes, and residential gateways. Ideal for digital silicon tuner applications, TOKO's RF filter design expertise provides for excellent insertion loss and rejection performance in an economical, fully shielded, and durable structure.



### FEATURES

- TOKO Product Type: **DIP1A**
- Fully Shielded Structure
- Integrated F-connector
- 75Ω Ports
- DOCSIS 1.0/1.1/2.0 Compliant
- Surge Protection Circuit
  - Bellcore 1089, Surge 1 First Level
- Operating Temperature: 0°C to + 70°C
- Storage Temperature: - 40°C to + 70°C
- Humidity: 30 to 85% RH (w/out condensation)
- Detailed specifications available upon request.

### DIMENSIONS

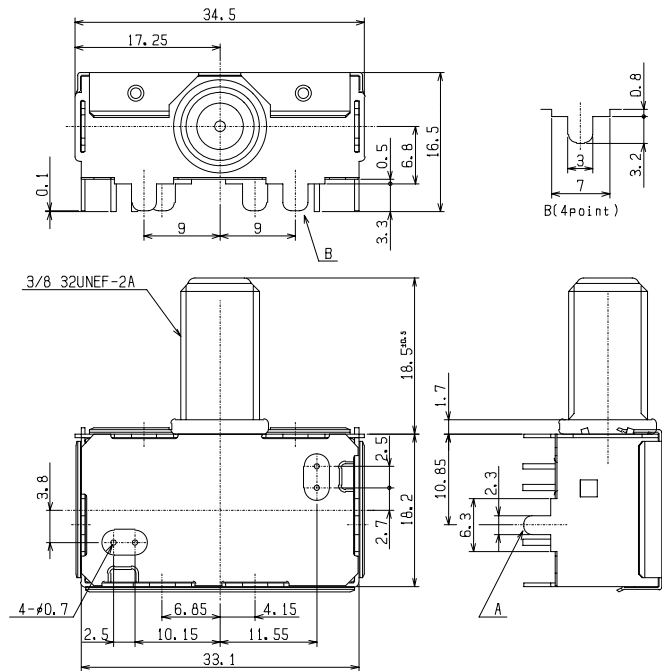

Tolerance: ±0.3mm  
Units: mm

### CONNECTIONS (BOTTOM VIEW)

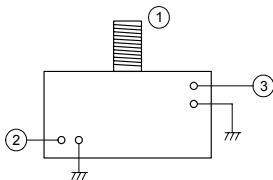

1. F-connector (75Ω)
2. Downstream (HPF) (75Ω)
3. Upstream (LPF) (75Ω)

### ELECTRICAL SPECIFICATIONS

TOKO Part Number	Region of Application	Low Pass Filter Passband (MHz)	High Pass Filter Passband (MHz)	Impedance (Ω)	Detailed Specifications
R975ACITN-1029B	North America	5~42	88~860	75	Note 1
R975ACJVN-1041	Europe, China	5~65	108~860	75	Note 1
R975ACITN-1036B	Japan	10~55	90~770	75	Note 1

**Note 1:** Detailed specifications to qualified customers available upon request. Contact TOKO America for details <http://www.tokoam.com/>.

### TYPICAL CHARACTERISTICS

#### R975ACITN-1029B (North America)

##### Attenuation and Insertion Loss (TX to Cable, 75Ω)

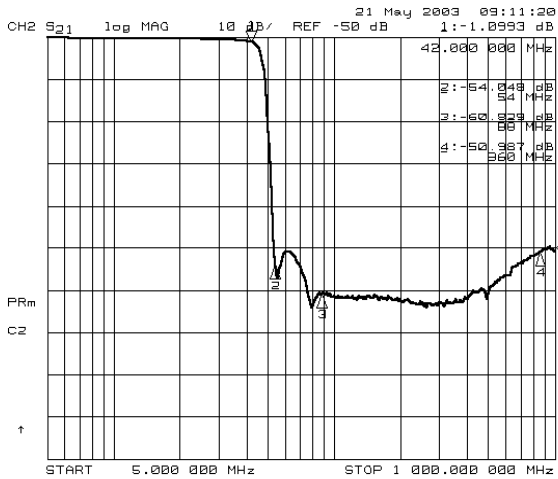

##### Attenuation and Insertion Loss (Cable to RX, 75Ω)

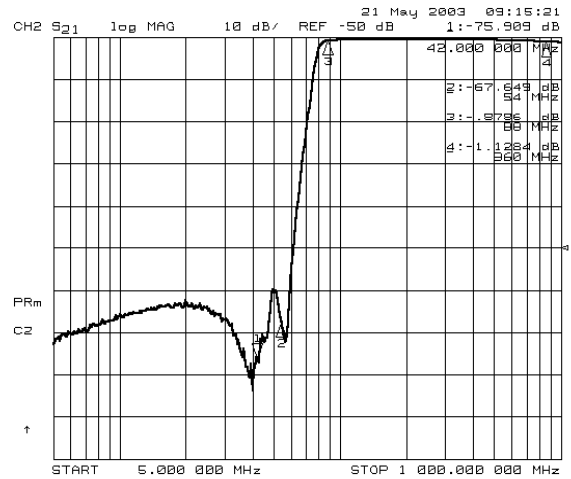

##### Coaxial Port Return Loss

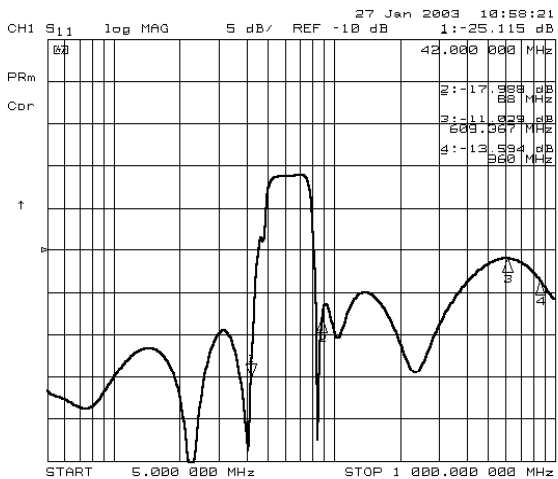

##### RX-TX Isolation

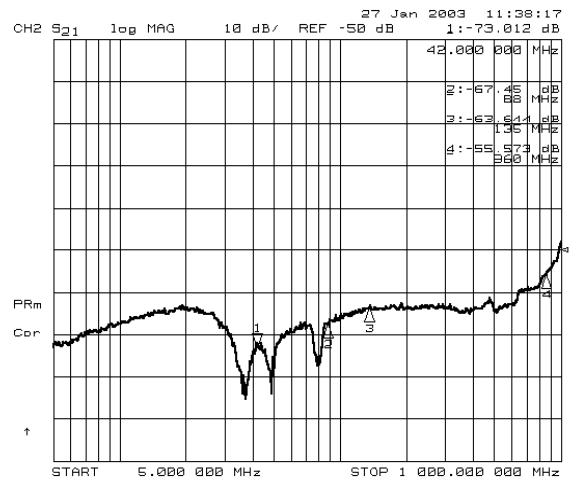

### TYPICAL CHARACTERISTICS

#### R975ACJVN-1041 (Europe, China)

##### Attenuation and Insertion Loss (TX to Cable, 75Ω)

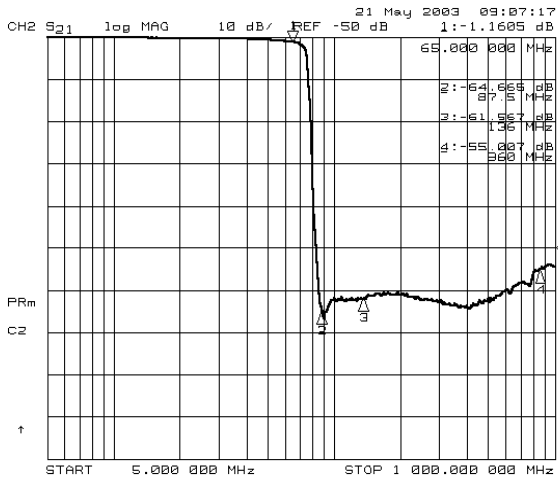

##### Attenuation and Insertion Loss (Cable to RX, 75Ω)

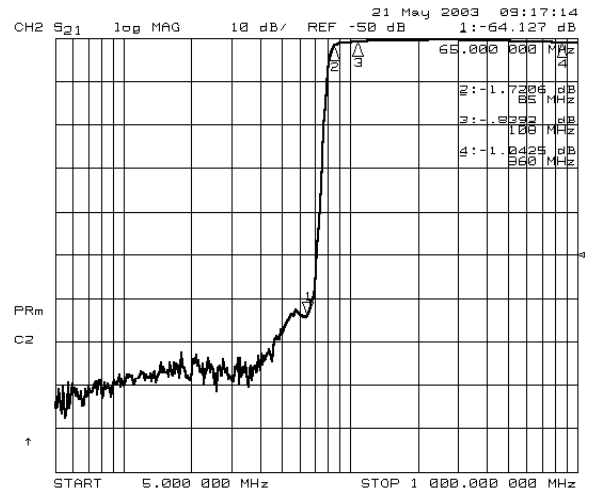

##### Coaxial Port Return Loss

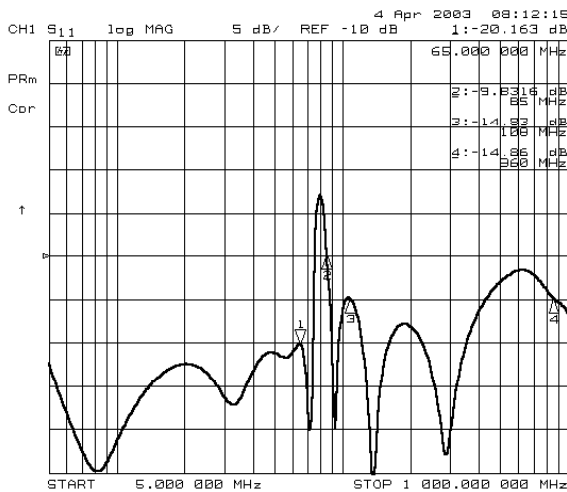

##### RX-TX Isolation

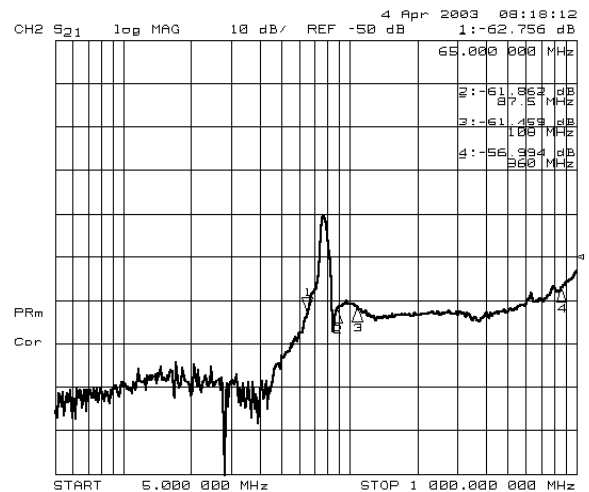

### TYPICAL CHARACTERISTICS

#### R975ACITN-1036B (Japan)

Attenuation and Insertion Loss (TX to Cable, 75Ω)

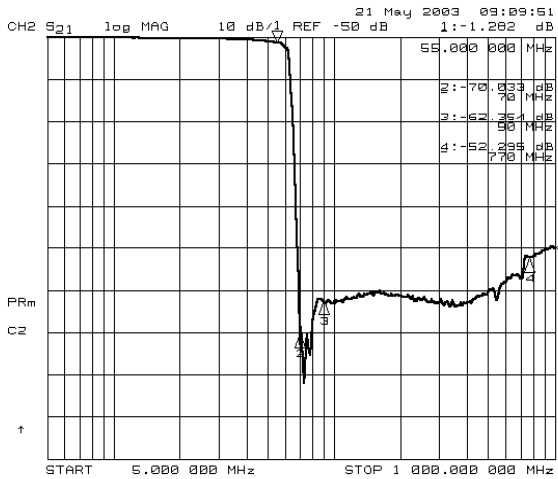

Attenuation and Insertion Loss (Cable to RX, 75Ω)

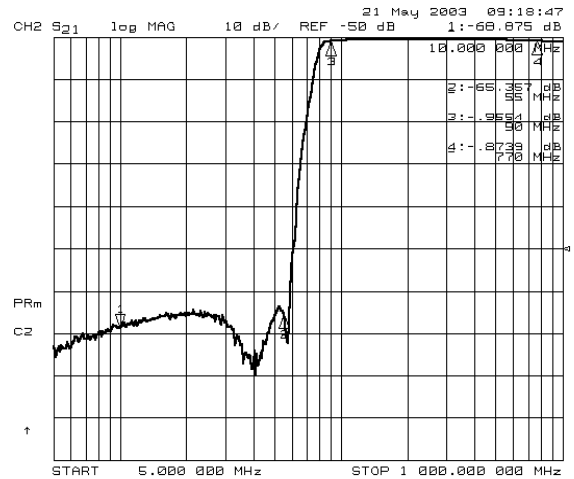

Coaxial Port Return Loss

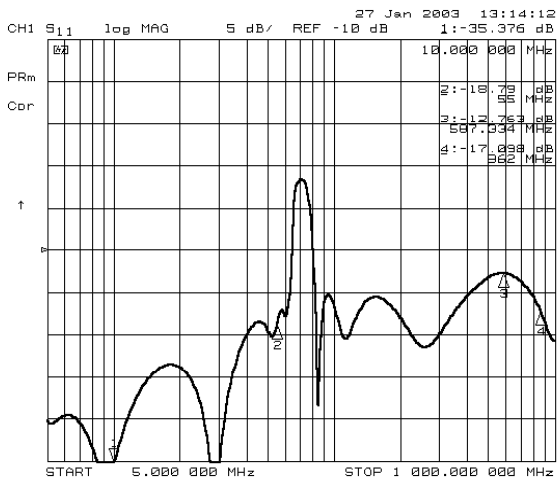

RX-TX Isolation

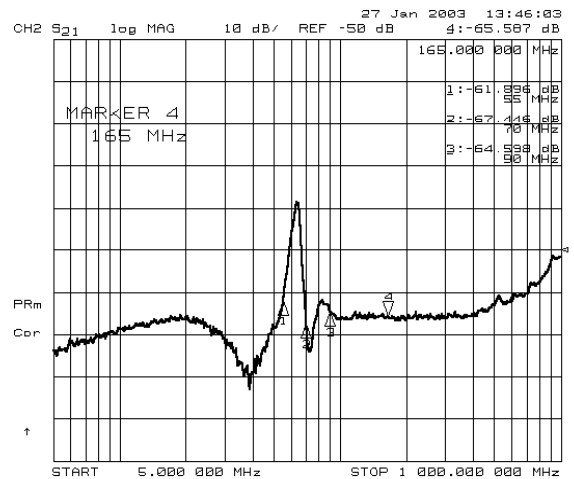

The information furnished by TOKO, Inc., is believed to be accurate and reliable. However, TOKO reserves the right to make changes or improvements in the design, specification, or manufacture of its products without further notice. TOKO does not assume any liability arising from the application or use of any product or circuit described herein, nor for infringements of patents or other rights of third parties which may result from the use of its products. No license is granted by implication or otherwise under any patent or patent rights of TOKO, Inc.