

Turbo 2 ultrafast high voltage rectifier

Main product characteristics

$I_{F(AV)}$	8 A
V_{RRM}	600 V
I_R (max)	200 μ A
T_j	175° C
V_F (typ)	0.85 V
t_{rr} (typ)	75 ns

Features and benefits

- Ultrafast switching
- Low reverse recovery current
- Low thermal resistance
- Reduces switching and conduction losses
- Package insulation voltage:
TO-220AC Ins: 2500 V_{RMS}
TO-220FPAC: 2000 V_{DC}

Description

The STTH8L06, which is using ST Turbo2 600V technology, is specially suited as boost diode in discontinuous or critical mode power factor corrections.

The device is also intended for use as a free wheeling diode in power supplies and other power switching applications.

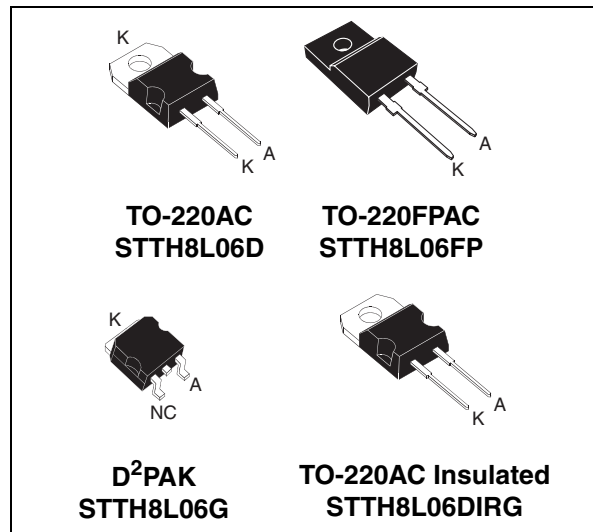

Order codes

Part Number	Marking
STTH8L06D	STTH8L06D
STTH8L06FP	STTH8L06FP
STTH8L06G	STTH8L06G
STTH8L06G-TR	STTH8L06G
STTH8L06DIRG	STTH8L06DI

Table 1. Absolute ratings (limiting values)

Symbol	Parameter		Value	Unit	
V_{RRM}	Repetitive peak reverse voltage		600	V	
$I_{F(RMS)}$	RMS forward current	TO-220AC / TO-220FPAC / D ² PAK	30	A	
		TO-220AC Ins.	24		
$I_{F(AV)}$	Average forward current $\delta = 0.5$	TO-220AC / D ² PAK	8	A	
		TO-220FPAC			$T_c = 150^\circ$ C
		TO-220AC Ins.			$T_c = 125^\circ$ C
I_{FSM}	Surge non repetitive forward current		120	A	
T_{stg}	Storage temperature range		-65 to 175	°C	
T_j	Operating junction temperature range		-40 to 175	°C	

1 Characteristics

Table 2. Thermal resistance

Symbol	Parameter		Value (max)	Unit
$R_{th(j-c)}$	Junction to case	TO-220AC / D ² PAK /	2.5	°C/W
		TO-220FPAC	5	
		TO-220AC Ins.	4	

Table 3. Static electrical characteristics

Symbol	Parameter	Test conditions		Min	Typ	Max	Unit
I_R	Reverse leakage current	$T_j = 25^\circ\text{C}$	$V_R = V_{RRM}$			8	μA
		$T_j = 150^\circ\text{C}$			16	200	
V_F	Forward voltage drop	$T_j = 25^\circ\text{C}$	$I_F = 8\text{ A}$			1.3	V
		$T_j = 150^\circ\text{C}$			0.85	1.05	

To evaluate the conduction losses use the following equation: $P = 0.89 \times I_{F(AV)} + 0.022 I_{F(RMS)}^2$

Table 4. Dynamic characteristics

Symbol	Parameter	Test conditions		Min	Typ	Max	Unit
t_{rr}	Reverse recovery time	$T_j = 25^\circ\text{C}$	$I_F = 1\text{ A}, dI_F/dt = -50\text{ A}/\mu\text{s}, V_R = 30\text{ V}$		75	105	ns
t_{fr}	Forward recovery time	$T_j = 25^\circ\text{C}$	$I_F = 8\text{ A}, dI_F/dt = 100\text{ A}/\mu\text{s}$ $V_{FR} = 1.1 \times V_{Fmax}$			150	ns
V_{FP}	Forward recovery voltage		$I_F = 8\text{ A}, dI_F/dt = 100\text{ A}/\mu\text{s}$			6	V

Figure 1. Conduction losses versus average current

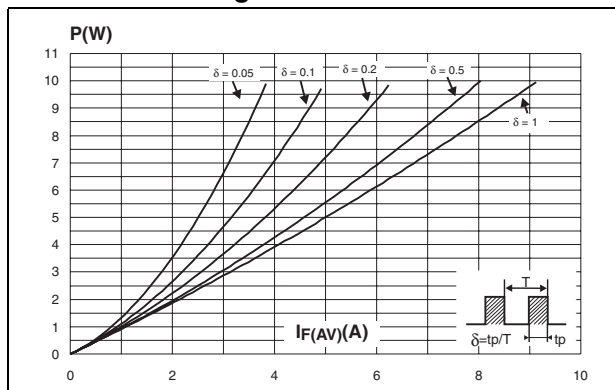

Figure 2. Forward voltage drop versus forward current

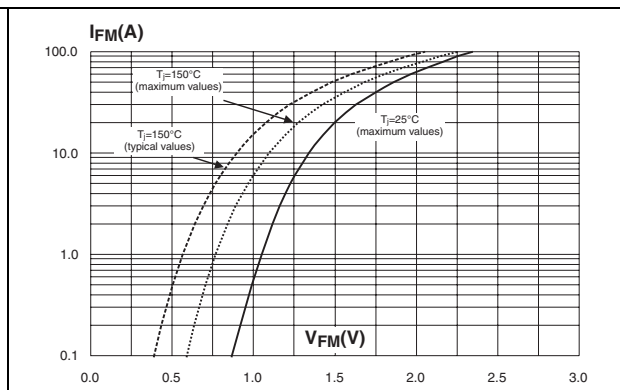

Figure 3. Relative variation of thermal impedance junction to case versus pulse duration (TO-220FPAC)

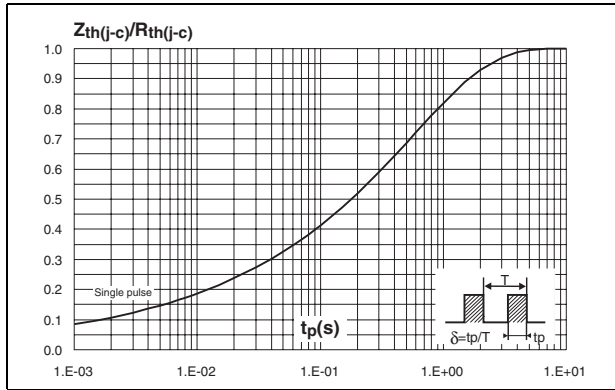

Figure 4. Relative variation of thermal impedance junction to case versus pulse duration (TO-220AC, TO-220AC Ins, D²PAK)

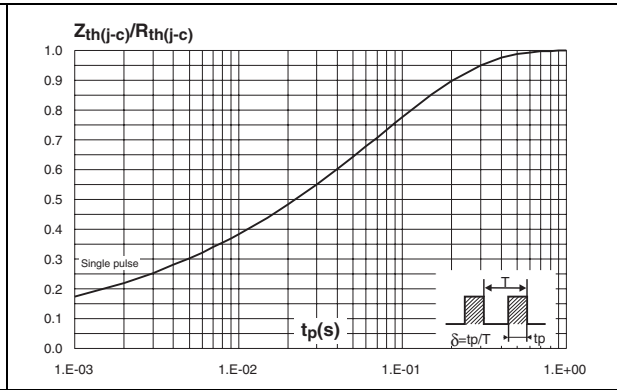

Figure 5. Peak reverse recovery current versus di_F/dt (typical values)

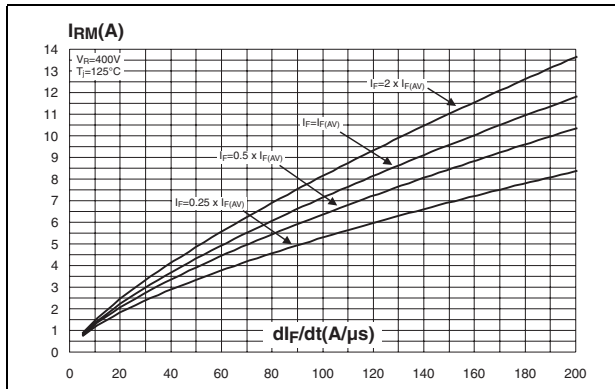

Figure 6. Reverse recovery time versus di_F/dt (typical values)

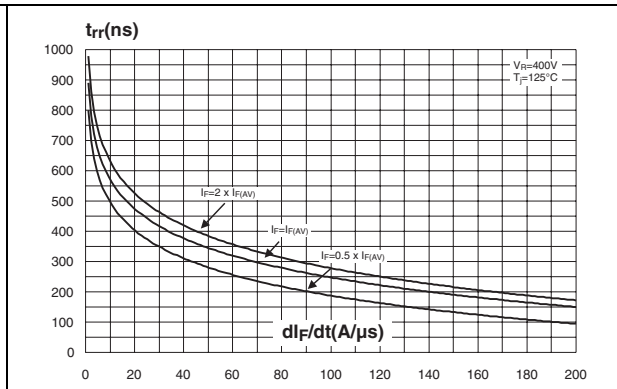

Figure 7. Reverse recovery charges versus di_F/dt (typical values)

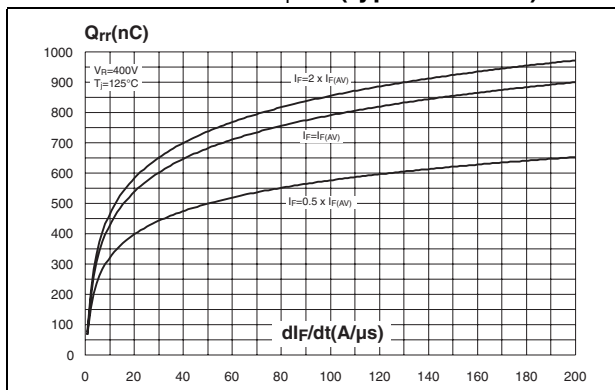

Figure 8. Softness factor versus di_F/dt (typical values)

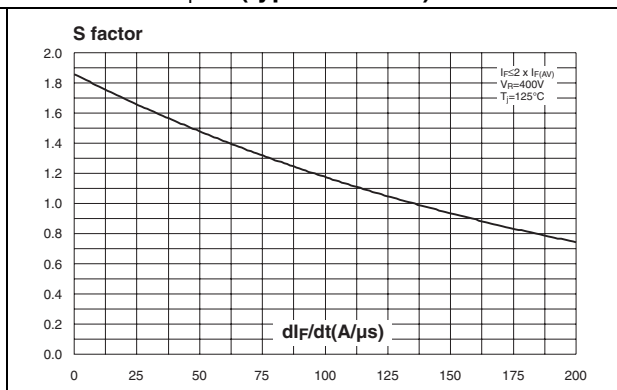

Figure 9. Relative variations of dynamic parameters versus junction temperature

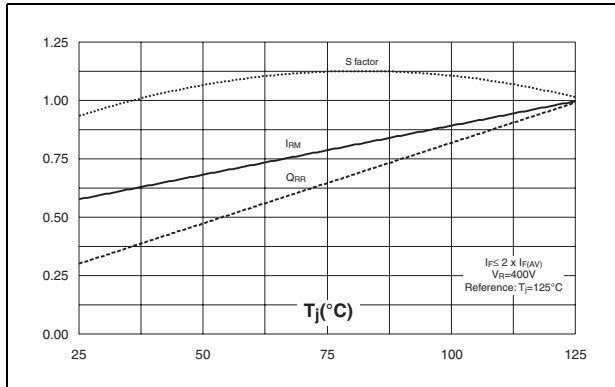

Figure 10. Transient peak forward voltage versus di_F/dt (typical values)

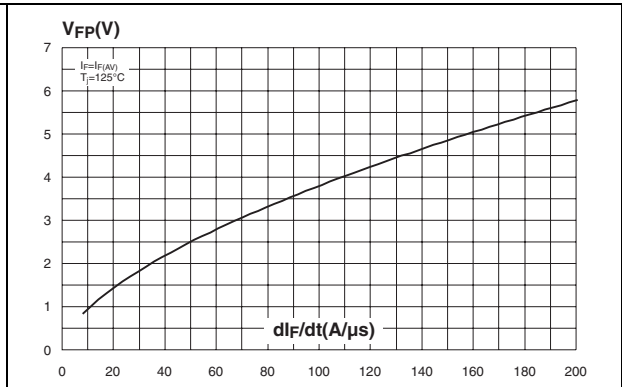

Figure 11. Forward recovery time versus di_F/dt (typical values)

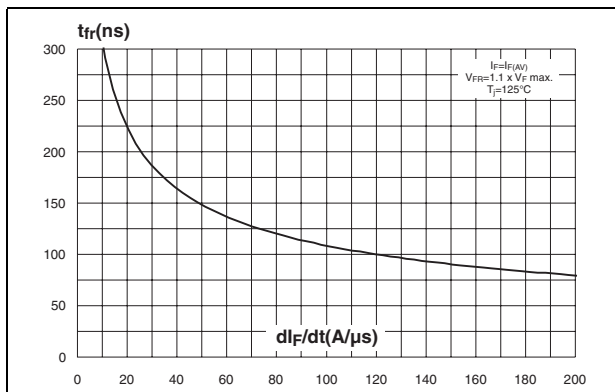

Figure 12. Junction capacitance versus reverse voltage applied (typical values)

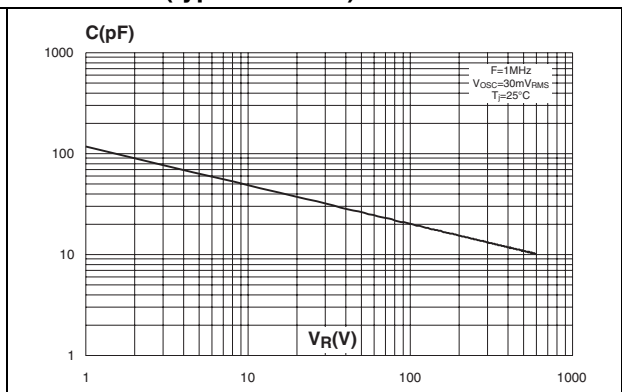
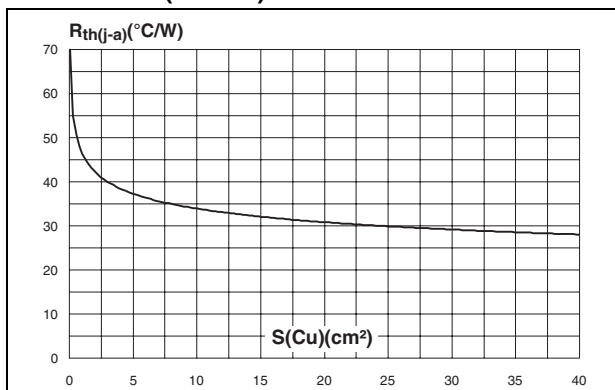

Figure 13. Thermal resistance junction to ambient versus copper surface under tab (epoxy FR4, $e_{CU} = 35 \mu m$) (D²PAK)



2 Package information

- Epoxy meets UL94, V0
- Cooling method: by conduction (C)
- Recommended torque value: 0.8 Nm (TO-220FPAC) / 0.55 Nm (TO-220AC)
- Maximum torque value: 1.0 Nm (TO-220FPAC) / 0.70 Nm (TO-220AC)

Table 5. TO-220AC dimensions

Ref.	Dimensions			
	Millimeters		Inches	
	Min.	Max.	Min.	Max.
A	4.40	4.60	0.173	0.181
C	1.23	1.32	0.048	0.051
D	2.40	2.72	0.094	0.107
E	0.49	0.70	0.019	0.027
F	0.61	0.88	0.024	0.034
F1	1.14	1.70	0.044	0.066
G	4.95	5.15	0.194	0.202
H2	10.00	10.40	0.393	0.409
L2	16.40 typ.		0.645 typ.	
L4	13.00	14.00	0.511	0.551
L5	2.65	2.95	0.104	0.116
L6	15.25	15.75	0.600	0.620
L7	6.20	6.60	0.244	0.259
L9	3.50	3.93	0.137	0.154
M	2.6 typ.		0.102 typ.	
Diam. I	3.75	3.85	0.147	0.151

Table 6. TO-220FPAC Dimensions

Ref.	Dimensions			
	Millimeters		Inches	
	Min.	Max.	Min.	Max.
A	4.4	4.6	0.173	0.181
B	2.5	2.7	0.098	0.106
D	2.5	2.75	0.098	0.108
E	0.45	0.70	0.018	0.027
F	0.75	1	0.030	0.039
F1	1.15	1.70	0.045	0.067
G	4.95	5.20	0.195	0.205
G1	2.4	2.7	0.094	0.106
H	10	10.4	0.393	0.409
L2	16 Typ.		0.63 Typ.	
L3	28.6	30.6	1.126	1.205
L4	9.8	10.6	0.386	0.417
L5	2.9	3.6	0.114	0.142
L6	15.9	16.4	0.626	0.646
L7	9.00	9.30	0.354	0.366
Dia.	3.00	3.20	0.118	0.126

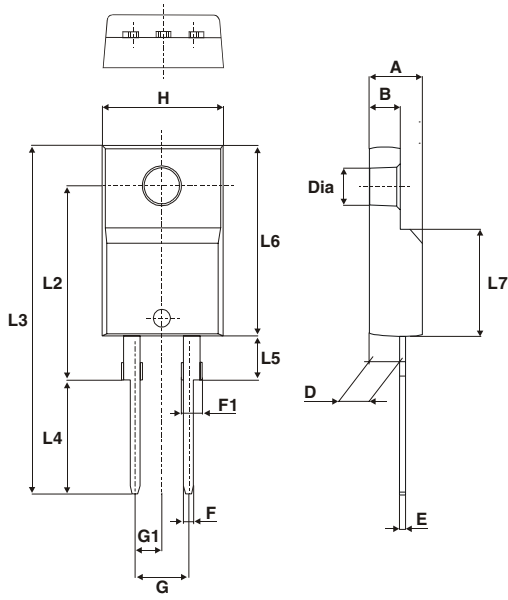

Table 7. TO-220AC (Nlns. & Ins. 20-up) Dimensions

Ref.	Dimensions					
	Millimeters			Inches		
	Min.	Typ.	Max.	Min.	Typ.	Max.
A	15.20		15.90	0.598		0.625
a1		3.75			0.147	
a2	13.00		14.00	0.511		0.551
B	10.00		10.40	0.393		0.409
b1	0.61		0.88	0.024		0.034
b2	1.23		1.32	0.048		0.051
C	4.40		4.60	0.173		0.181
c1	0.49		0.70	0.019		0.027
c2	2.40		2.72	0.094		0.107
e	4.80		5.40	0.189		0.212
F	6.20		6.60	0.244		0.259
ØI	3.75		3.85	0.147		0.151
l4	15.80	16.40	16.80	0.622	0.646	0.661
L	2.65		2.95	0.104		0.116
l2	1.14		1.70	0.044		0.066
M		2.60			0.102	

Table 8. D²PAK Dimensions

Ref.	Dimensions			
	Millimeters		Inches	
	Min.	Max.	Min.	Max.
A	4.40	4.60	0.173	0.181
A1	2.49	2.69	0.098	0.106
A2	0.03	0.23	0.001	0.009
B	0.70	0.93	0.027	0.037
B2	1.14	1.70	0.045	0.067
C	0.45	0.60	0.017	0.024
C2	1.23	1.36	0.048	0.054
D	8.95	9.35	0.352	0.368
E	10.00	10.40	0.393	0.409
G	4.88	5.28	0.192	0.208
L	15.00	15.85	0.590	0.624
L2	1.27	1.40	0.050	0.055
L3	1.40	1.75	0.055	0.069
M	2.40	3.20	0.094	0.126
R	0.40 typ.		0.016 typ.	
V2	0°	8°	0°	8°

Figure 14. Footprint (dimensions in mm)

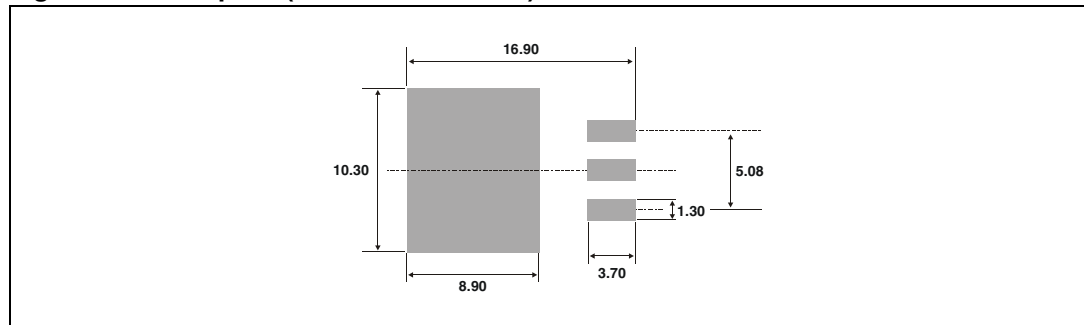

3 Ordering information

Ordering type	Marking	Package	Weight	Base qty	Delivery mode
STTH8L06D	STTH8L06D	TO-220AC	1.90 g	50	Tube
STTH8L06G	STTH8L06G	D ² PAK	1.48 g	50	Tube
STTH8L066G-TR	STTH8L06G	D ² PAK	1.48 g	1000	Tape and reel
STTH8L06FP	STTH8L06FP	TO-220FPAC	1.70 g	50	Tube
STTH8L06DIRG	STTH8L06DI	TO-220AC Ins.	1.86 g	50	Tube

4 Revision history

Date	Revision	Changes
Nov-2002	2A	Last issue
18-Oct-2004	3	TO-220AC Insulated and D ² PAK packages added
13-Jun-2005	4	T _j changed from value 175 to range -40 to 175° C - Page1
10-Aug-2006	5	Reformatted to current standard. Added package insulation voltage data on page 1. Changed order code STTH8L06DI to STTH8L06DIRG.

Please Read Carefully:

Information in this document is provided solely in connection with ST products. STMicroelectronics NV and its subsidiaries ("ST") reserve the right to make changes, corrections, modifications or improvements, to this document, and the products and services described herein at any time, without notice.

All ST products are sold pursuant to ST's terms and conditions of sale.

Purchasers are solely responsible for the choice, selection and use of the ST products and services described herein, and ST assumes no liability whatsoever relating to the choice, selection or use of the ST products and services described herein.

No license, express or implied, by estoppel or otherwise, to any intellectual property rights is granted under this document. If any part of this document refers to any third party products or services it shall not be deemed a license grant by ST for the use of such third party products or services, or any intellectual property contained therein or considered as a warranty covering the use in any manner whatsoever of such third party products or services or any intellectual property contained therein.

UNLESS OTHERWISE SET FORTH IN ST'S TERMS AND CONDITIONS OF SALE ST DISCLAIMS ANY EXPRESS OR IMPLIED WARRANTY WITH RESPECT TO THE USE AND/OR SALE OF ST PRODUCTS INCLUDING WITHOUT LIMITATION IMPLIED WARRANTIES OF MERCHANTABILITY, FITNESS FOR A PARTICULAR PURPOSE (AND THEIR EQUIVALENTS UNDER THE LAWS OF ANY JURISDICTION), OR INFRINGEMENT OF ANY PATENT, COPYRIGHT OR OTHER INTELLECTUAL PROPERTY RIGHT.

UNLESS EXPRESSLY APPROVED IN WRITING BY AN AUTHORIZED ST REPRESENTATIVE, ST PRODUCTS ARE NOT RECOMMENDED, AUTHORIZED OR WARRANTED FOR USE IN MILITARY, AIR CRAFT, SPACE, LIFE SAVING, OR LIFE SUSTAINING APPLICATIONS, NOR IN PRODUCTS OR SYSTEMS WHERE FAILURE OR MALFUNCTION MAY RESULT IN PERSONAL INJURY, DEATH, OR SEVERE PROPERTY OR ENVIRONMENTAL DAMAGE. ST PRODUCTS WHICH ARE NOT SPECIFIED AS "AUTOMOTIVE GRADE" MAY ONLY BE USED IN AUTOMOTIVE APPLICATIONS AT USER'S OWN RISK.

Resale of ST products with provisions different from the statements and/or technical features set forth in this document shall immediately void any warranty granted by ST for the ST product or service described herein and shall not create or extend in any manner whatsoever, any liability of ST.

ST and the ST logo are trademarks or registered trademarks of ST in various countries.

Information in this document supersedes and replaces all information previously supplied.

The ST logo is a registered trademark of STMicroelectronics. All other names are the property of their respective owners.

© 2006 STMicroelectronics - All rights reserved

STMicroelectronics group of companies

Australia - Belgium - Brazil - Canada - China - Czech Republic - Finland - France - Germany - Hong Kong - India - Israel - Italy - Japan - Malaysia - Malta - Morocco - Singapore - Spain - Sweden - Switzerland - United Kingdom - United States of America

www.st.com