

Low Cost MMIC Mixer

1400 MHz - 2100 MHz

MD54-0006

V1.00

Features

- +12 dBm Input Power @ 1 dB Compression
- High Isolation, 28 dB LO to RF
- +3 to +8 dBm LO Drive Level
- DC - 500 MHz 3 dB IF Bandwidth
- Does not require DC bias
- Ultra-Miniature SOT-25 plastic Package

Description

M/A-COM's MD54-0006 is a passive mixer that achieves the performance of a double balanced diode mixer in an ultra-miniature SOT-25 package. The MD54-0006 is ideally suited for use where high level RF signals and very wide dynamic range are required. Typical applications include frequency up/down conversion, modulation, and demodulation in receivers and transmitters for basestation and portable systems.

The MD54-0006 uses FETs as mixing elements to achieve very wide dynamic range in a low cost plastic package. The mixer operates with LO drive levels of +3 dBm to +8 dBm. The LO port may be externally tuned for operation in various frequency bands.

M/A-COM's MD54-0006 is fabricated using a mature 0.5 micron gate length GaAs MESFET process. The process features full passivation for increased performance and reliability. The MD54-0006 is 100 % RF tested to ensure performance specification compliance.

SOT-25

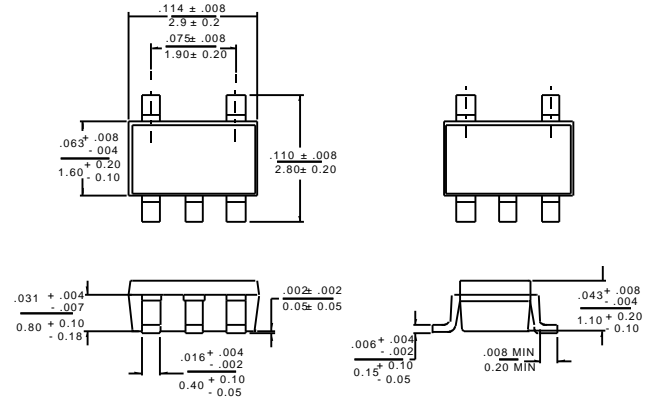

Ordering Information

Part Number	Package
MD54-0006	SOT-25 5 Lead Plastic
MD54-0006TR	Forward Tape and Reel *
MD54-0006SMB	Designer's Kit

* If specific reel size is required, consult factory for part number assignment.

Electrical Specifications RF = 1850 MHz (-10 dBm), LO = 1710MHz (+5 dBm), IF = 140 MHz, \pm 25°C

Parameter	Test Conditions	Units	Min.	Typ.	Max.
Conversion Loss		dB		8.0	9.0
Isolation	LO to RF	dB	20	28	
	LO to IF	dB		15	
	RF to IF	dB		15	
VSWR	RF Port			2.0:1	
	LO Port ¹			2.0:1	
	IF Port			2.0:1	
Input 1 dB Compression	RF Freq. = 1850 MHz, LO = +5 dBm	dBm		12	
Two-Tone IM Ratio ²	Two Tones at -10 dBm each Tone spacing = 100 kHz, IF = 140 Mhz	dBc		55	

1. With external LO Port matching. See functional diagram on Page 2.
2. IMR vs . RF Drive can be calculated by the formula: $IMR=40-1.5 \cdot P_{in}$

Specifications Subject to Change Without Notice.

Absolute Maximum Ratings¹

Parameter	Absolute Maximum
RF Input Power ²	+27 dBm
LO Drive Power ²	+27 dBm
Storage Temperature	-40 °C to +85 °C
Operating Temperature	-65 °C to +150 °C

- Exceeding any one or combination of these limits may cause permanent damage.
- Ambient Temperature (\bar{T}) = +25°C

Functional Block Diagram

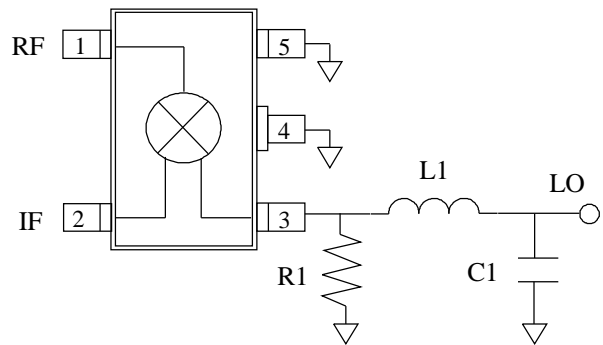

Pin Configuration

Pin No.	Pin Name	Description
1	RF Port	RF Input
2	IF Port	IF Output
3	LO Port	LO Input
4	GND	Ground
5	GND	Ground

External Circuitry Parts List

Part	LO Frequency		
	1500 MHz	1710 MHz	2300 MHz
R1	470 ohms	470 ohms	820 ohms
L1	6.8 nH	4.7 nH	2.7 nH
C1	3.3 pF	2.2 pF	2.2 pF

- The external LO matching network allows tuning from 1400 MHz to 2300 MHz. The networks given above are intended to serve as guidelines for matching in different bands.
- All off-chip components are low-cost surface mount components obtainable from multiple sources. (0.060 in. x 0.030 in. or 0.080 in. x 0.050 in.)

Recommended PCB Configuration

Layout View

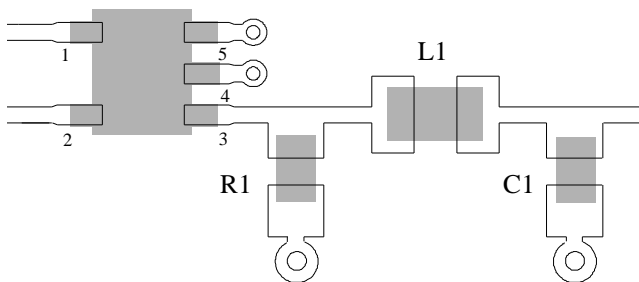

Cross Section View

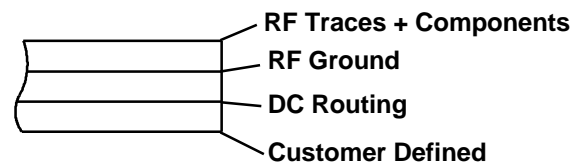

The PCB dielectric between RF traces and RF ground layers should be chosen to reduce RF discontinuities between 50Ω lines and package pins. M/A-COM recommends an FR-4 dielectric thickness of 0.008" (0.2 mm) yielding a 50Ω line width of 0.015" (0.38 mm). The recommended metalization thickness is 1 ounce copper.

Typical Performance Data

- **Test Conditions for Down Converter Application** RF = 1850 MHz (-10 dBm), IF = 140 MHz , LO = 1710 MHz (+5 dBm), LO Port match shown on page 2.
- **Test Conditions for Up Converter Application** LO = 1710 MHz (+5 dBm), IF = 140 MHz (-10 dBm), RF = 1850 MHz LO Port match shown on page 2.

CONVERSION LOSS (UP/DOWN) vs. FREQUENCY

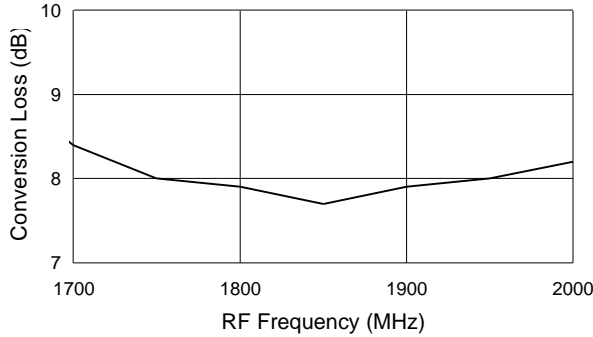

VSWR vs. FREQUENCY

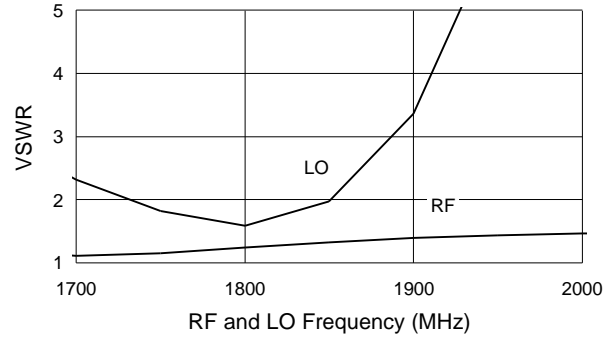

TWO-TONE IMR vs. FREQUENCY

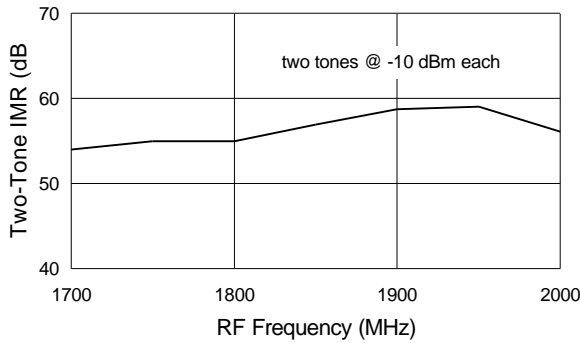

ISOLATION vs. FREQUENCY

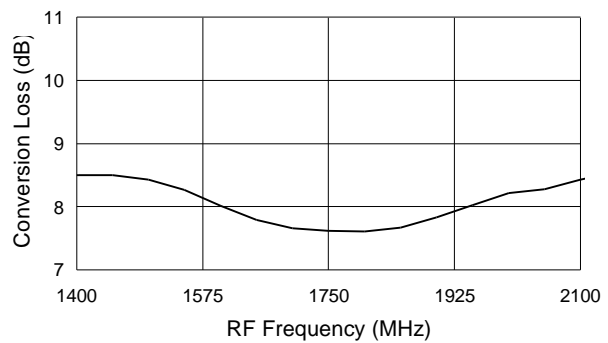

Wide-Band Performance Data

Test Conditions for Wide-Band Application: RF = -10 dBm, IF = 140 MHz , LO = +11 dBm, LO Port resistively matched. Lower LO drive operation is available for narrow band performance using external reactive matching. The 3 dB IF bandwidth is 500 MHz. IF frequencies above 200 MHz can be optimized for low conversion loss by using external matching components.

CONVERSION LOSS vs. FREQUENCY

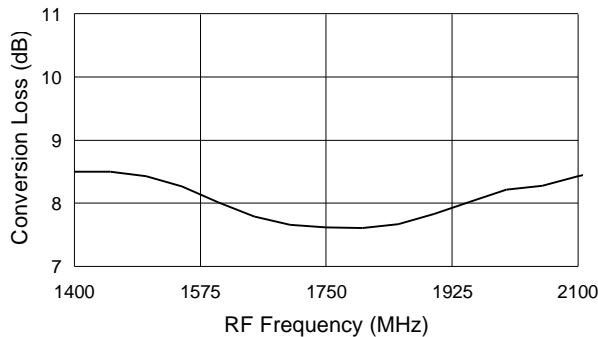

TWO-TONE IMR vs. FREQUENCY

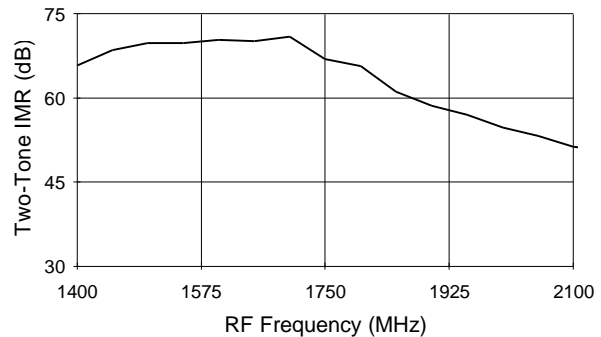

Specifications Subject to Change Without Notice.

Spurious Table (dBc)

(n)	4x	38.3	41.3	45.4	64.7	57.0
H		27.3	39.9	52.5	77.1	78.7
a	3x	21.4	30.1	69.0	43.0	68.3
r		10.5	30.1	70.5	58.8	76.8
m	2x	9.0	36.1	36.0	65.8	64.3
o		-0.9	36.4	45.8	75.0	78.0
n	1x	1.9	0	44.8	56.1	65.0
i		-6.0	0	55.5	75.2	78.3
c	0x	X	8.1	45.5	56.8	72.9
		X	8.3	54.4	72.3	74.3
of		0x	1x	2x	3x	4x
LO	Harmonic of RF (m)					

The spurious table shows the spurious signals resulting from the mixing of the RF and LO input signals assuming down conversion. Mixing products are indicated relative to the IF. The lower frequency mixing term is shown for two different RF input levels. The upper number is for an RF input power of 0 dBm; the lower number is for an RF level of -10 dBm.

$ nF_{RF} - mF_{LO} $, (RF = 0 dBm)	RF Frequency = 1850 MHz
$ nF_{RF} - mF_{LO} $, (RF = -10 dBm)	LO Frequency = 1710 MHz

Designer's Kit MD54-0006SMB

The MD54-0006SMB Designer's Kit allows for immediate evaluation of M/A-COM's MD54-0006. The Designer's Kit consists of an MD54-0006, an evaluation board, and a floppy disk containing typical performance data and a DXF file of the recommended PCB layout.

The evaluation board consists of the recommended external surface mount circuitry and RF connectors mounted to a multi-layer PCB. The MD54-0006SMB evaluation PCB is shown below with all functional ports labeled.

Evaluation PCB + RF Connector Losses

Port Reference	Approximate RF Loss
RF Port	0.30 dB @ 1850 MHz
LO Port	0.20 dB @ 1710 MHz
IF Port	0.075 dB @ 140 MHz

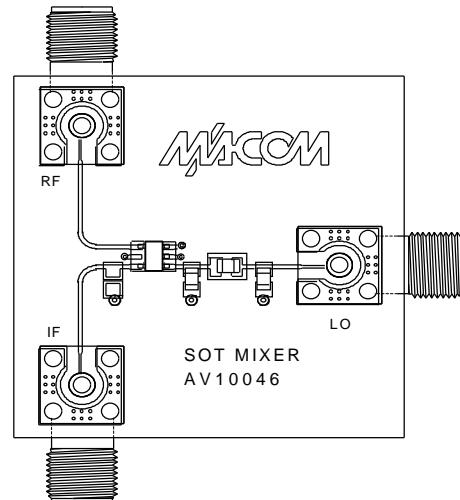

MIXER PCB

Specifications Subject to Change Without Notice.