

Variable Capacitance Diode

Description

The 1T368A is a variable capacitance diode designed for electronic tuning of wide-band CATV tuners using a super miniature package.

Features

- Super miniature package
- Low series resistance: 0.75Ω Max. (f = 470MHz)
- Large capacitance ratio: 11.5 Typ. (C₂/C₂₅)
- Small leakage current: 10nA Max. (V_R = 28V)
- Capacitance deviation in a matching group: within 2%

Applications

Electronic tuning of wide-band CATV tuners

Structure

Silicon epitaxial planar type diode

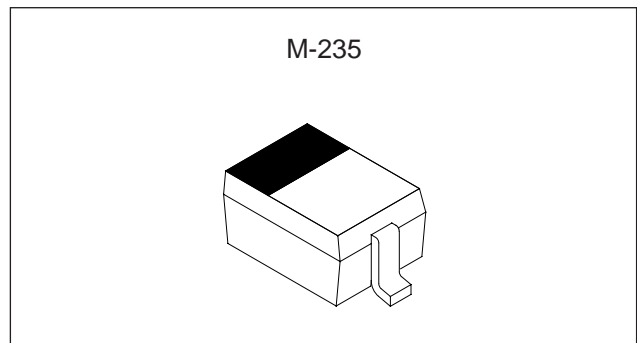

Absolute Maximum Ratings (Ta = 25°C)

- Reverse voltage V_R 34 V
- Operating temperature Topr -20 to +75 °C
- Storage temperature Tstg -65 to +150 °C

Electrical Characteristics

(Ta = 25°C)

Item	Symbol	Conditions	Min.	Typ.	Max.	Unit
Reverse voltage	V _R	I _R = 1μA	34.0			V
Reverse current	I _R	V _R = 28V			10.0	nA
Diode capacitance	C ₂	V _R = 2V, f = 1MHz	29.54		33.54	pF
	C ₂₅	V _R = 25V, f = 1MHz	2.64		2.94	pF
Capacitance ratio	C ₂ /C ₂₅		11.0	11.5		
	C ₂₅ /C ₂₈		1.03			
Series resistance	r _s	C _D = 14pF, f = 470MHz			0.75	Ω
Capacitance deviation in a matching group	ΔC	V _R = 2 to 25V, f = 1MHz			2.0	%

Sony reserves the right to change products and specifications without prior notice. This information does not convey any license by any implication or otherwise under any patents or other right. Application circuits shown, if any, are typical examples illustrating the operation of the devices. Sony cannot assume responsibility for any problems arising out of the use of these circuits.

Diode capacitance vs. Reverse voltage

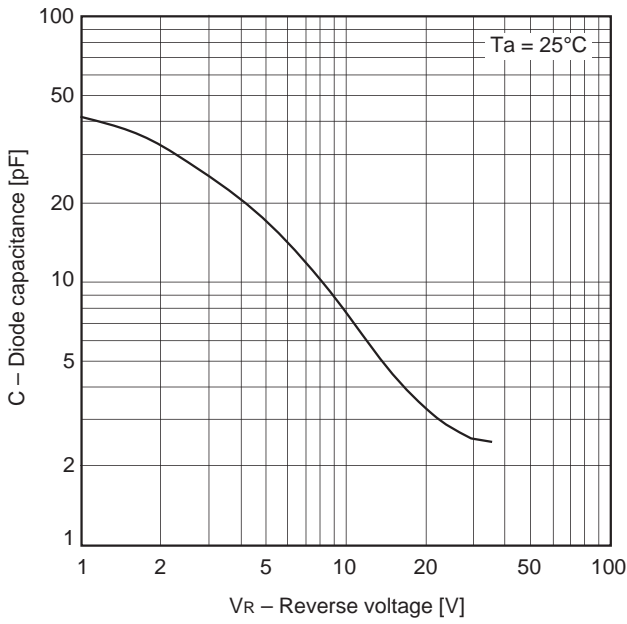

Reverse current vs. Ambient temperature

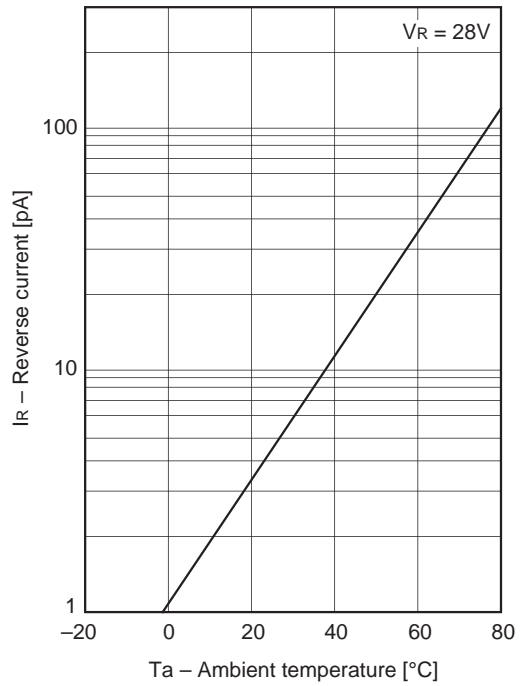

Forward voltage vs. Ambient temperature

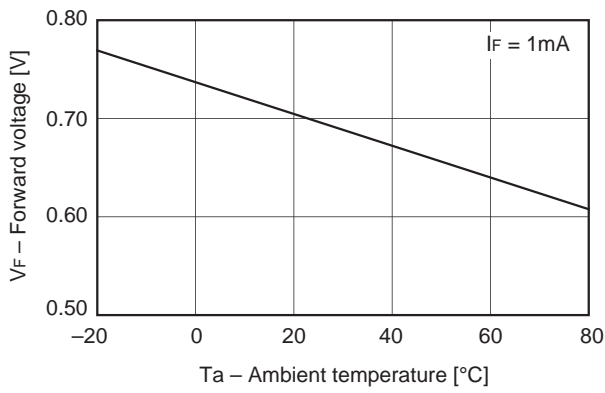

Reverse voltage vs. Ambient temperature

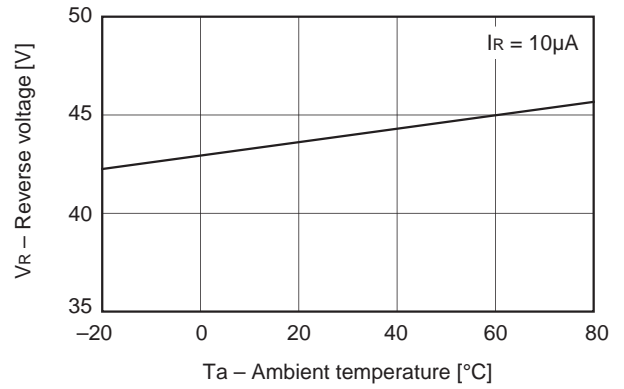

Diode capacitance vs. Ambient temperature

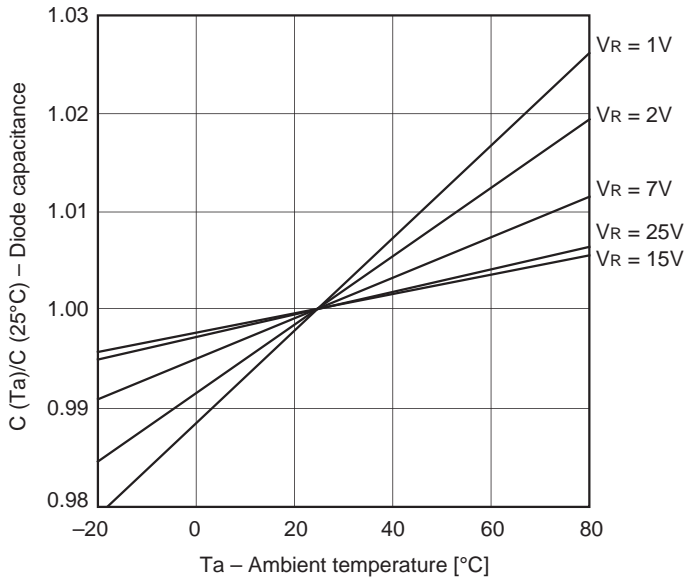

Reverse current vs. Reverse voltage

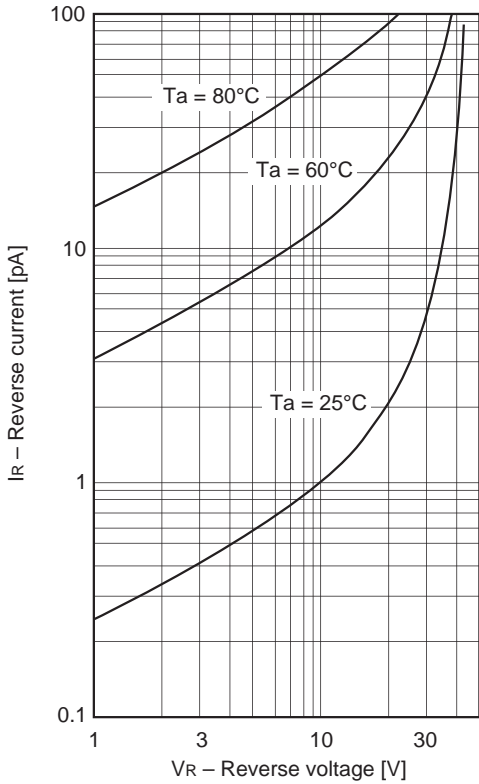

Temperature coefficient of diode capacitance

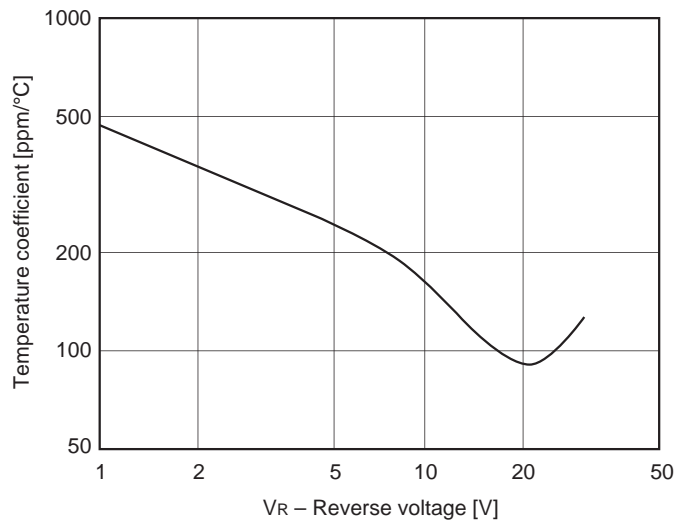

Package Outline

Unit: mm

M-235

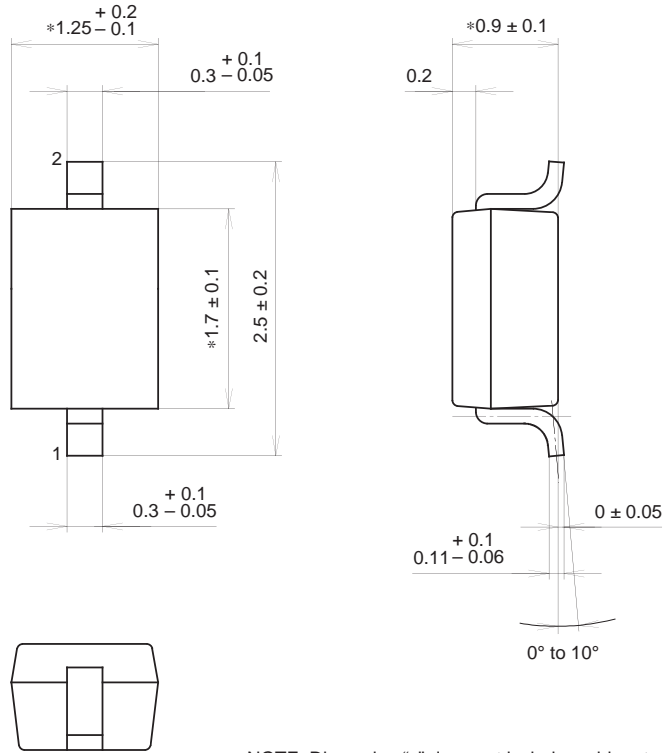

NOTE: Dimension "*" does not include mold protrusion.

SONY CODE	M-235
EIAJ CODE	_____
JEDEC CODE	_____

PACKAGE WEIGHT	0.1g
----------------	------

Marking

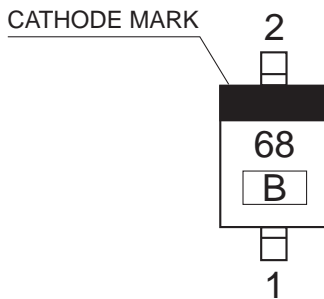

Notes

- 1) B: Lot No. (Year and Month of manufacture)
 Year; Last one digit
 Month; A, B, C (for Oct. to Dec.)
 1 to 9 (for Jan. to Sept.)

This datasheet has been download from:

www.datasheetcatalog.com

Datasheets for electronics components.