



# LV1110NM

## Digital Surround Processor IC

### Overview

The LV1110NM is a digital surround processor IC developed for miniature stereo components and radio-cassette combinations. The major features built into this Bi-CMOS single-chip solution are function switching, recording volume control, surround processing, karaoke processing, 3-band graphic equalizer, and master volume control.

### Features

- The built-in delay functions include input and output filters, analog-to-digital and digital-to-analog converters, delay lines with built-in memory, and delay reverberation. Other functions available are fixed matrix (L+R and L-R) and front mixing (choice of level or phase). These functions may be freely combined to easily produce a variety of surround modes and thus simulate a wide range of acoustic environments.
- The built-in karaoke functions include a vocal canceler, microphone echo, key control I/O, and other support for audio multiplexing software.

### Functions

- Input function switching (Five channels with built-in 6-dB amplifier)
- Two REC output pins with volume controls (Two channels with on/off switches and choice of function output or mixer output)
- Input switching (choice of L+R, L-R, and L or R only)
- Microphone input (on/off)
- Vocal canceler
- Key control I/O pins

- Front addition (+3 dB, -3 dB, -5 dB, mute)
- I/O filters in delay block (choice of 2-, 5-, and 28-kHz low pass filters or through operation)
- Reverberation functions (with built-in volume control)
- Built-in SRAM (8 kilobytes)
- Variable delay (choice of 15, 20, 25, 30, 40, 50, 100, and 120 ms)
- Built-in  $V_{DD}$
- I/O through or mute
- Three-band graphic equalizer (boost or cut with three steps each)
- Master volume control from 0 to -79 dB in 1-dB steps
- QIP-64E package with 0.8-mm pin pitch

### Package Dimensions

unit: mm

#### 3159-QFP64E

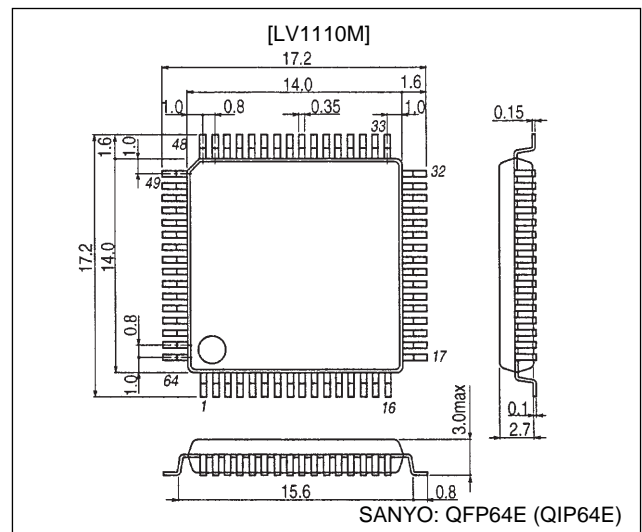

■ Any and all SANYO products described or contained herein do not have specifications that can handle applications that require extremely high levels of reliability, such as life-support systems, aircraft's control systems, or other applications whose failure can be reasonably expected to result in serious physical and/or material damage. Consult with your SANYO representative nearest you before using any SANYO products described or contained herein in such applications.

■ SANYO assumes no responsibility for equipment failures that result from using products at values that exceed, even momentarily, rated values (such as maximum ratings, operating condition ranges, or other parameters) listed in products specifications of any and all SANYO products described or contained herein.

**SANYO Electric Co., Ltd. Semiconductor Business Headquarters**

TOKYO OFFICE Tokyo Bldg., 1-10, 1 Chome, Ueno, Taito-ku, TOKYO, 110-8534 JAPAN

## LV1110NM

### Specifications

#### Absolute Maximum Ratings at $T_a = 25^\circ\text{C}$

Parameter	Symbol	Conditions	Ratings	Unit
Maximum power supply voltage	$V_{CC\ max}$		12	V
Maximum power dissipation	$P_{d\ max}$	$T_a \leq 70^\circ\text{C}$ 114.3 × 76.1 × 1.6 mm <sup>3</sup> Mounted on glass epoxy circuit board	500	mW
Operating temperature	$T_{opr}$		-25 to +70	°C
Storage temperature	$T_{stg}$		-40 to +125	°C

#### Operating Conditions at $T_a = 25^\circ\text{C}$

Parameter	Symbol	Conditions	Ratings	Unit
Recommended power supply voltage	$V_{CC}$		9	V
Operating power supply voltage range	$V_{CC\ opg}$		8 to 11	V
Control data high-level voltage	$V_{IH}$		3.5 to 5.5	V
Control data low-level voltage	$V_{IL}$		0 to 1.2	V

#### Electrical Characteristics at $T_a = 25^\circ\text{C}$ , $V_{CC} = 9\text{ V}$ , $f_{IN} = 1\text{ kHz}$ , $V_{IN} = 300\text{ mVrms} = 0\text{ dB}$ , $R_L = 10\text{ k}\Omega$

Parameter	Symbol	Conditions	Ratings			Unit
			min	typ	max	
Quiescent current	$I_{CCO}$		19	28	42	mA
Input function switching (measured for function in input / function out)						
Output level deviation	$VG_{F1}$	IN A, D	-2	0	+2	dB
	$VG_{F2}$	IN B, C, E	4	6	8	dB
Maximum output voltage	$V_{OF}$	$V_{CC} = 8.5\text{ V}$ , THD = 1%	2.0	2.4		V
Distortion	$THD_F$	400 to 30 kHz BPF		0.005	0.03	%
Output noise voltage	$V_{NOF}$	$R_g = 10\text{ k}\Omega$ , JISA		-102	-95	dBV
Interchannel crosstalk	$CT_F$	$R_g = 10\text{ k}\Omega/V_O = 1\text{ Vrms}$ , JIS A	82	100		dB
L and R channel total throughput (measured for L and R inputs and L and R outputs)						
Output level deviation	$VG_T$		-2	0	+2	dB
Signal handling	$SH_T$	$V_{CC} = 8.5\text{ V}$ , THD = 1%, 300 mVrms = 0 dB	15.0	16.5		dB
Distortion	$THD_T$	400 to 30 kHz BPF		0.005	0.03	%
Signal-to-noise ratio	$SNT$	$R_g = 10\text{ k}\Omega$ , CCIR-ARM, 300 mVrms = 0 dB	85	100		dB
Interchannel crosstalk	$CT_T$	$R_g = 10\text{ k}\Omega/V_O = 1\text{ Vrms}$ , JIS A	82	94		dB
S channel (measured for delay = 20 ms, reverb. off, L-R, S-IN input, S-OUT output)						
Output level deviation	$VG_S$		-3	0	+3	dB
Signal handling	$SH_S$	THD = 3%, 300 mVrms = 0 dB, $V_{CC} = 8.5\text{ V}$	15.0	16.5		dB
Distortion	$THD_S$	400 to 30 kHz BPF, OUT FILTER: 5 kHz LPF		0.1	0.7	%
Signal-to-noise ratio	$SN_S$	$R_g = 10\text{ k}\Omega$ , CCIR-ARM, 300 mVrms = 0 dB OUT FILTER: 5 kHz LPF	60	68		dB
Long delay (measured for delay = 100 ms, reverb. off, MIC-IN input, S-OUT output)						
Output level deviation	$VG_D$	OUT FILTER: 2 kHz LPF	-4.5	-1.5	+1.5	dB
Maximum output voltage	$V_{OD}$	THD = 3%, $V_{CC} = 8.5\text{ V}$	1.4	1.8		V
Distortion	$THD_D$	400 to 30 kHz BPF, OUT FILTER: 2 kHz LPF		2.0	3.0	%
Output noise voltage	$V_{NOD}$	$R_g = 10\text{ k}\Omega$ , JIS A, OUT FILTER: 2 kHz LPF		-75	-66	dBV
Vocal cut	$VC$		-16	-20	-24	dB
[REC output (measured for volume = 0 dB, function in, A input, REC OUT)]						
Output level deviation	$VG_R$		-2	0	+2	dB
Maximum output voltage	$V_{OR}$	THD = 1%, $V_{CC} = 8.5\text{ V}$	1.6	2.0		V
Distortion	$THD_R$	400 to 30 kHz BPF		0.006	0.03	%
Output noise voltage	$V_{NOR}$	$R_g = 10\text{ k}\Omega$ , JIS A		-106	-95	dBV
Interchannel crosstalk	$CT_R$	$R_g = 10\text{ k}\Omega/V_O = 1\text{ Vrms}$ , JIS A	82	100		dB
Mute attenuation ratio	$MT_R$	JIS A, $V_{IN} = 1\text{ Vrms} = 0\text{ dB}$	-75	-86		dB

Continued on next page.

# LV1110NM

Continued from preceding page.

## Electrical Characteristics at $T_a = 25^\circ\text{C}$ , $V_{CC} = 9\text{ V}$ , $f_{IN} = 1\text{ kHz}$ , $V_{IN} = 300\text{ mVrms} = 0\text{ dB}$ , $R_L = 10\text{ k}\Omega$

Parameter	Symbol	Conditions	Ratings			Unit
			min	typ	max	
Master volume control (measured for volume = maximum, VOL IN input, VOL OUT output)						
Output level deviation	$V_{GV}$		-2	0	+2	dB
Maximum output voltage	$V_{OV}$	$V_{CC} = 8.5\text{ V}$ , THD = 1%	1.6	2.0		V
Distortion	$THD_V$	400 to 30 kHz BPF		0.006	0.03	%
Output noise voltage	$V_{NOV}$	$R_g = 10\text{ k}\Omega$ , JIS A		-107	-95	dBV
Interchannel crosstalk	$CT_V$	$R_g = 10\text{ k}\Omega/V_O = 1\text{ Vrms} = 0\text{ dB}$ , JIS A	85	103		dB
Mute attenuation ratio	$MT_V$	JIS A, $V_{IN} = 300\text{ mV} = 0\text{ dB}$	-70	-78		dB
Graphic equalizer (measured for IN,L,R input / OUT L,R )						
Boost amount	$VGE_{U1}$	BASS: $f_{IN} = 100\text{ Hz}$ , MID: $f_{IN} = 1\text{ kHz}$ , TREBLE: BOOST1: $f_{IN} = 10\text{ kHz}$	1.7	3	4.3	dB
	$VGE_{U2}$	BASS: $f_{IN} = 100\text{ Hz}$ , MID: $f_{IN} = 1\text{ kHz}$ , TREBLE: BOOST2: $f_{IN} = 10\text{ kHz}$	4.7	6	7.3	dB
	$VGE_{U3}$	BASS: $f_{IN} = 100\text{ Hz}$ , MID: $f_{IN} = 1\text{ kHz}$ , TREBLE: BOOST3: $f_{IN} = 10\text{ kHz}$	8.5	10	11.5	dB
Cut amount	$VGE_{D1}$	BASS: $f_{IN} = 100\text{ Hz}$ , MID: $f_{IN} = 1\text{ kHz}$ , TREBLE: CUT1: $f_{IN} = 10\text{ kHz}$	-4.3	-3	-1.7	dB
	$VGE_{D2}$	BASS: $f_{IN} = 100\text{ Hz}$ , MID: $f_{IN} = 1\text{ kHz}$ , TREBLE: CUT2: $f_{IN} = 10\text{ kHz}$	-7.3	-6	-4.7	dB
	$VGE_{D3}$	BASS: $f_{IN} = 100\text{ Hz}$ , MID: $f_{IN} = 1\text{ kHz}$ , TREBLE: CUT3: $f_{IN} = 10\text{ kHz}$	-11.5	-10	-8.5	dB

## Block Diagram

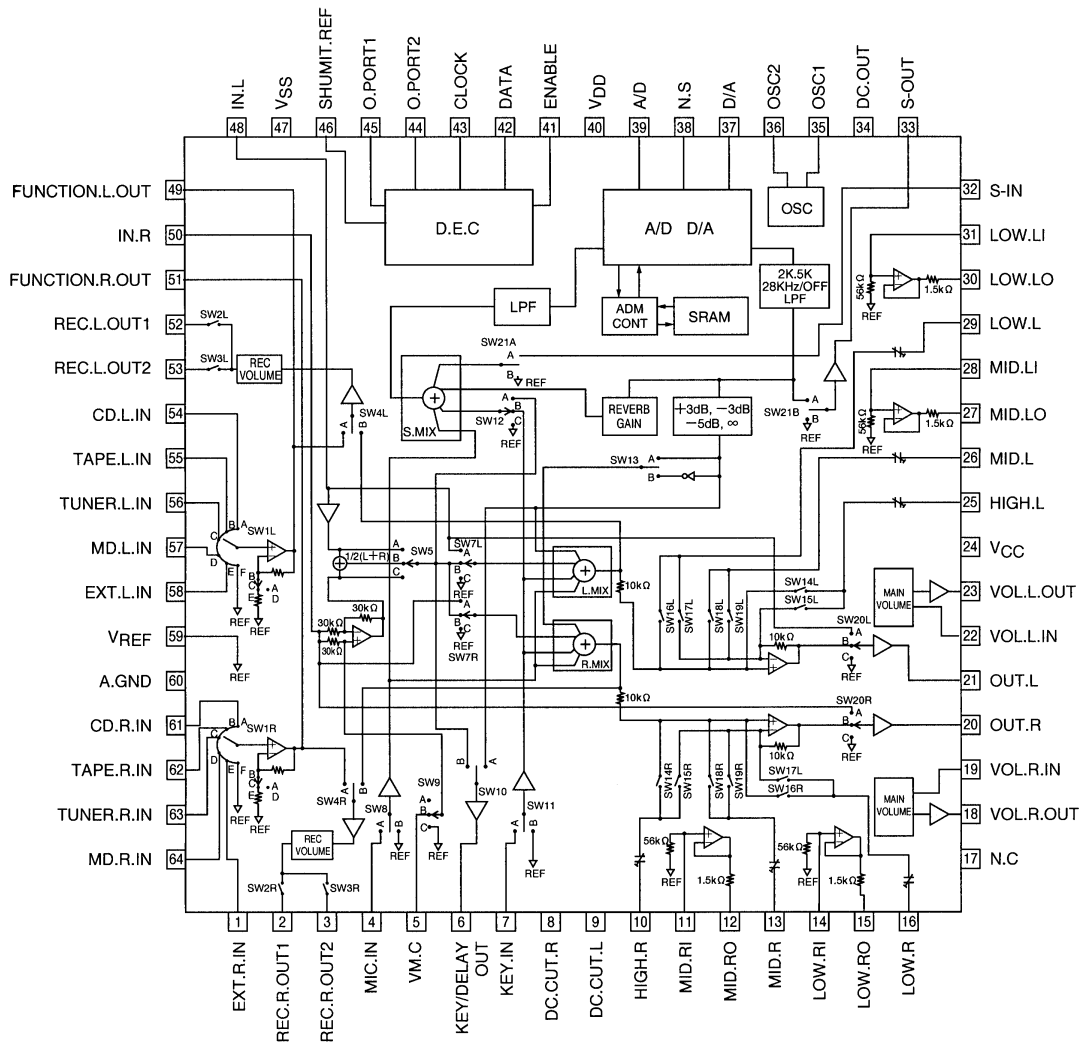

A10960

# LV1110NM

## Measurement Circuit

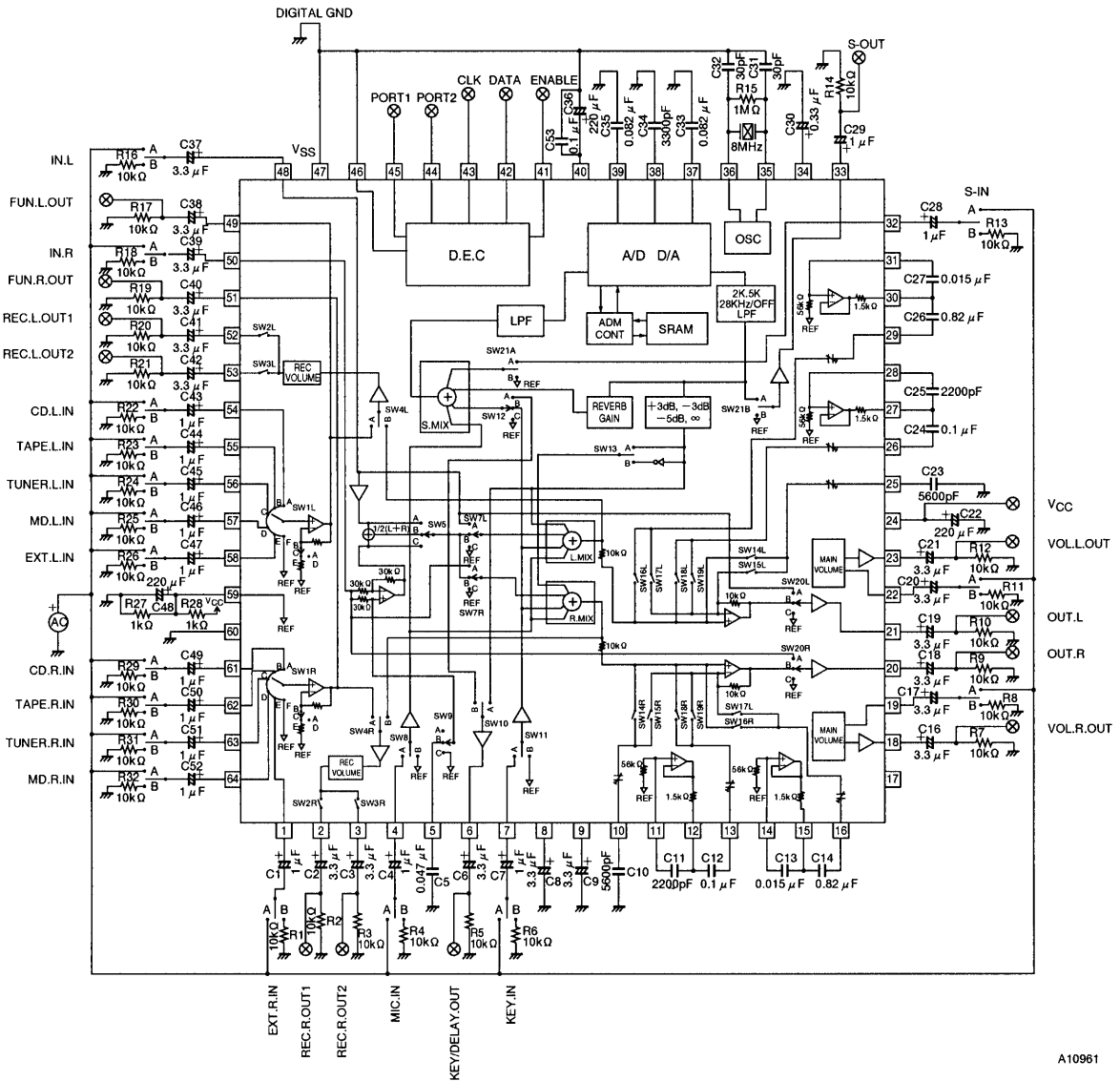

A10961



## LV1110NM

### Control Format

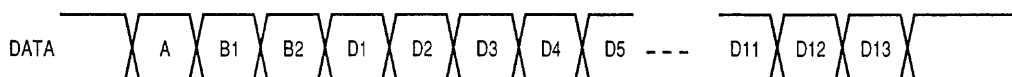

A10963

A = "Low" level selects the LV1110M.

B1 and B2 specify the data mode (LL, HL, LH, or HH).

D1 to D13 give the data.

A = L, B1 = L, B2 = L

Input function switching

D1, D2, D3	Function	Notes
L, L, L	MUTE	SW1 = F
L, L, H	CD.IN	SW1 = A
L, H, L	Tape.IN	SW1 = B, VG = 6 dB
L, H, H	Tuner.IN	SW1 = C, VG = 6 dB
H, L, L	MD.IN	SW1 = D
H, L, H	EXT.IN	Sw1 = E, VG = 6 dB

### Input switching

See the Block Diagram for the SW modes.

D4, D5, D6	Function	SW5	SW9	SW20
L, L, L	L + R	B	A	B
L, L, H	L - R	B	C	B
L, H, L	L Only	A	A	B
L, H, H	R Only	C	A	B
H, L, L	Matrix Through	B	A	B
H, L, H	Total Through	B	A	A

Vocal canceler (When on, set D4, D5, and D6 for L+R mode.)

	L	H
D7	OFF : SW9 = A	ON : SW9 = B

### Microphone input

	L	H
D8	OFF : SW8 = B	ON : SW8 = A

### Key control switching

D9	Function	SW7	SW10	SW11
L	OFF	A/B	A	B
H	ON	C	B	A

### Stereo/matrix switching

	L	H
D10	SW7 = A	SW7 = B

### S-IN/S-OUT switching

	L	H
D11	SW OFF	SW ON

### Delay input switching

	Function
L, L	SW12 = C
L, H	SW12 = A
H, L	SW12 = B

## LV1110NM

A = L, B1 = H, B2 = L

### Out filter switching

D1, D2	Level
L, L	Through
L, H	28 kHz L.P.F.
H, L	5 kHz, L.P.F.
H, H	2 kHz L.P.F.

### Reverberation level

D3, D4, D5	Level
L, L, L	$-\infty$
L, L, H	-9 dB
L, H, L	-7 dB
L, H, H	-5 dB
H, L, L	-3 dB
H, L, H	-2 dB
H, H, L	-1 dB
H, H, H	0 dB

### Delay

D6, D7, D8	Level
L, L, L	15 ms
L, L, H	20 ms
L, H, L	25 ms
L, H, H	30 ms
H, L, L	40 ms
H, L, H	50 ms
H, H, L	100 ms
H, H, H	120 ms

### System muting

	L	H
D9	Muting on	Muting off

### L and R muting

	L	H
D10	Muting on	Muting off

### Effect R channel ADD

	L	H
D11	In-phase addition SW13 = A	Inverted phase addition SW13 = B

### Front ADD effect volume

D12, D13	Level
L, L	$-\infty$
L, H	-5 dB
H, L	-3 dB
H, H	+3 dB

## LV1110NM

---

A = L, B1 = L, B2 = H

Graphic equalizer BASS

D1, D2, D3	Level
L, L, L	-10 dB
L, L, H	-6 dB
L, H, L	-3 dB
L, H, H	0 dB
H, L, L	+10 dB
H, L, H	+6 dB
H, H, L	+3 dB
H, H, H	0 dB

Graphic equalizer MID

D4, D5, D6	Level
L, L, L	-10 dB
L, L, H	-6 dB
L, H, L	-3 dB
L, H, H	0 dB
H, L, L	+10 dB
H, L, H	+6 dB
H, H, L	+3 dB
H, H, H	0 dB

Graphic equalizer TREBLE

D7, D8, D9	Level
L, L, L	-10 dB
L, L, H	-6 dB
L, H, L	-3 dB
L, H, H	0 dB
H, L, L	+10 dB
H, L, H	+6 dB
H, H, L	+3 dB
H, H, H	0 dB

Port control (D10: PORT1, D11: PORT2)

	L	H
D10	L	H
D11	L	H



## LV1110NM

A = L, B1 = H, B2 = H, D1 = L

Left channel master volume control

Attenuation (dB)

D2	D3	D4	D5	D6	D7	D8	ATT	D2	D3	D4	D5	D6	D7	D8	ATT
L	L	L	L	L	L	L	0	L	H	L	H	L	H	L	-42
L	L	L	L	L	L	H	-1	L	H	L	H	L	H	H	-43
L	L	L	L	L	H	L	-2	L	H	L	H	H	L	L	-44
L	L	L	L	L	H	H	-3	L	H	L	H	H	L	H	-45
L	L	L	L	H	L	L	-4	L	H	L	H	H	H	L	-46
L	L	L	L	H	L	H	-5	L	H	L	H	H	H	H	-47
L	L	L	L	H	H	L	-6	L	H	H	L	L	L	L	-48
L	L	L	L	H	H	H	-7	L	H	H	L	L	L	H	-49
L	L	L	H	L	L	L	-8	L	H	H	L	L	H	L	-50
L	L	L	H	L	L	H	-9	L	H	H	L	L	H	H	-51
L	L	L	H	L	H	L	-10	L	H	H	L	H	L	L	-52
L	L	L	H	L	H	H	-11	L	H	H	L	H	L	H	-53
L	L	L	H	H	L	L	-12	L	H	H	L	H	H	L	-54
L	L	L	H	H	H	L	-13	L	H	H	L	H	H	H	-55
L	L	L	H	H	H	H	-14	L	H	H	H	L	L	L	-56
L	L	L	H	H	H	H	-15	L	H	H	H	L	L	H	-57
L	L	H	L	L	L	L	-16	L	H	H	H	L	H	L	-58
L	L	H	L	L	L	H	-17	L	H	H	H	L	H	H	-59
L	L	H	L	L	H	L	-18	L	H	H	H	H	L	L	-60
L	L	H	L	L	H	H	-19	L	H	H	H	H	L	H	-61
L	L	H	L	H	L	L	-20	L	H	H	H	H	H	L	-62
L	L	H	L	H	L	H	-21	L	H	H	H	H	H	H	-63
L	L	H	L	H	H	L	-22	H	L	L	L	L	L	L	-64
L	L	H	L	H	H	H	-23	H	L	L	L	L	L	H	-65
L	L	H	H	L	L	L	-24	H	L	L	L	L	H	L	-66
L	L	H	H	L	L	H	-25	H	L	L	L	L	H	H	-67
L	L	H	H	L	H	L	-26	H	L	L	L	H	L	L	-68
L	L	H	H	L	H	H	-27	H	L	L	L	H	L	H	-69
L	L	H	H	H	L	L	-28	H	L	L	L	H	H	L	-70
L	L	H	H	H	L	H	-29	H	L	L	L	H	H	H	-71
L	L	H	H	H	H	L	-30	H	L	L	H	L	L	L	-72
L	L	H	H	H	H	H	-31	H	L	L	H	L	L	H	-73
L	H	L	L	L	L	L	-32	H	L	L	H	L	H	L	-74
L	H	L	L	L	L	H	-33	H	L	L	H	L	H	H	-75
L	H	L	L	L	H	L	-34	H	L	L	H	H	L	L	-76
L	H	L	L	L	H	H	-35	H	L	L	H	H	L	H	-77
L	H	L	L	H	L	L	-36	H	L	L	H	H	H	L	-78
L	H	L	L	H	L	H	-37	H	L	L	H	H	H	H	-79
L	H	L	L	H	H	L	-38	H	L	H	L	L	L	L	-∞
L	H	L	L	H	H	H	-39	:	:	:	:	:	:	:	-∞
L	H	L	H	L	L	L	-40	:	:	:	:	:	:	:	-∞
L	H	L	H	L	L	H	-41	H	H	H	H	H	H	H	-∞

## LV1110NM

---

### REC volume

D9, D10, D11	Level
L, L, L	0 dB
L, L, H	-2 dB
L, H, L	-4 dB
L, H, H	-6 dB
H, L, L	-8 dB
H, L, H	-10 dB
H, H, L	-12 dB
H, H, H	-14 dB

## LV1110NM

A = L, B1 = H, B2 = H, D1 = L

Right channel master volume control

D2	D3	D4	D5	D6	D7	D8	ATT	D2	D3	D4	D5	D6	D7	D8	ATT
L	L	L	L	L	L	L	0	L	H	L	H	L	H	L	-42
L	L	L	L	L	L	H	-1	L	H	L	H	L	H	H	-43
L	L	L	L	L	H	L	-2	L	H	L	H	H	L	L	-44
L	L	L	L	L	H	H	-3	L	H	L	H	H	L	H	-45
L	L	L	L	H	L	L	-4	L	H	L	H	H	H	L	-46
L	L	L	L	H	L	H	-5	L	H	L	H	H	H	H	-47
L	L	L	L	H	H	L	-6	L	H	H	L	L	L	L	-48
L	L	L	L	H	H	H	-7	L	H	H	L	L	L	H	-49
L	L	L	H	L	L	L	-8	L	H	H	L	L	H	L	-50
L	L	L	H	L	L	H	-9	L	H	H	L	L	H	H	-51
L	L	L	H	L	H	L	-10	L	H	H	L	H	L	L	-52
L	L	L	H	L	H	H	-11	L	H	H	L	H	L	H	-53
L	L	L	H	H	L	L	-12	L	H	H	L	H	H	L	-54
L	L	L	H	H	H	L	-13	L	H	H	L	H	H	H	-55
L	L	L	H	H	H	H	-14	L	H	H	H	L	L	L	-56
L	L	H	L	L	L	L	-15	L	H	H	H	L	L	H	-57
L	L	H	L	L	L	H	-16	L	H	H	H	L	H	L	-58
L	L	H	L	L	H	L	-17	L	H	H	H	L	H	H	-59
L	L	H	L	L	H	H	-18	L	H	H	H	H	L	L	-60
L	L	H	L	H	L	L	-19	L	H	H	H	H	H	L	-61
L	L	H	L	H	L	H	-20	L	H	H	H	H	H	H	-62
L	L	H	L	H	H	L	-21	L	H	H	H	H	H	H	-63
L	L	H	L	H	H	H	-22	H	L	L	L	L	L	L	-64
L	L	H	H	L	L	L	-23	H	L	L	L	L	L	H	-65
L	L	H	H	L	L	L	-24	H	L	L	L	L	H	L	-66
L	L	H	H	L	H	L	-25	H	L	L	L	L	H	H	-67
L	L	H	H	L	H	L	-26	H	L	L	L	H	L	L	-68
L	L	H	H	L	H	H	-27	H	L	L	L	H	L	H	-69
L	L	H	H	H	L	L	-28	H	L	L	L	H	H	L	-70
L	L	H	H	H	L	H	-29	H	L	L	L	H	H	H	-71
L	L	H	H	H	H	L	-30	H	L	L	H	L	L	L	-72
L	L	H	H	H	H	H	-31	H	L	L	H	L	L	H	-73
L	H	L	L	L	L	L	-32	H	L	L	H	L	H	L	-74
L	H	L	L	L	L	H	-33	H	L	L	H	L	H	H	-75
L	H	L	L	L	H	L	-34	H	L	L	H	H	L	L	-76
L	H	L	L	L	H	H	-35	H	L	L	H	H	L	H	-77
L	H	L	L	H	L	L	-36	H	L	L	H	H	H	L	-78
L	H	L	L	H	L	H	-37	H	L	L	H	H	H	H	-79
L	H	L	L	H	H	L	-38	H	L	H	L	L	L	L	-∞
L	H	L	L	H	H	H	-39	:	:	:	:	:	:	:	-∞
L	H	L	H	L	L	L	-40	:	:	:	:	:	:	:	-∞
L	H	L	H	L	L	H	-41	H	H	H	H	H	H	H	-∞

## LV1110NM

### REC OUT input switching

	L	H
D9	Function output	Mixer output

### REC OUT on/off

	L	H
D10	OFF	ON
D11	OFF	ON

### Notes on control data

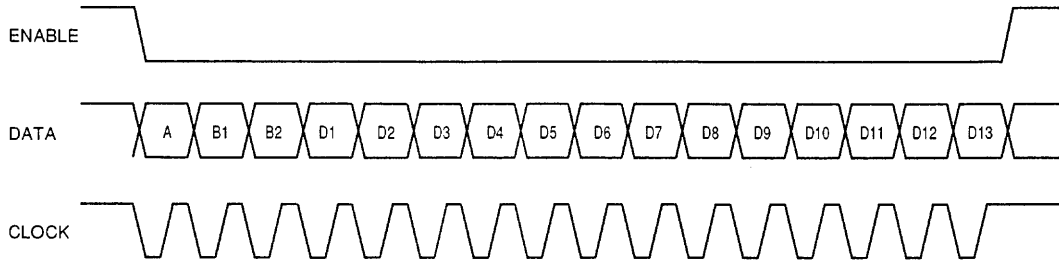

A10964

- The device latches the individual data bits of the command at the rising edge of the clock signal.
- One frame consists of 16 bits (A to D13).
- The device latches the data for the command at the rising edge of the enable signal.
- Maintain the clock and enable signals at High level when not controlling the LV1110NM.
- Maintain the enable signal at High level for at least 10  $\mu\text{s}$  between commands.

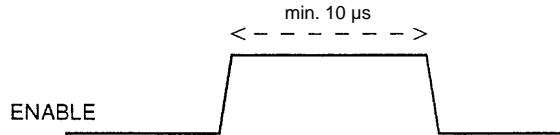

A10965

### Important note on mode control and using system muting

- When the power is first applied, allow the IC sufficient time to initialize (approximately 2 seconds) and then send it commands to turn system muting off and then on.
  - When changing the delay, always turn system muting on and then off—that is, send the new data with the command to turn system muting on and again with the command to turn it back off.
- Both operations enhance reliability by forcing the device to initialize its memory.

### Data timing

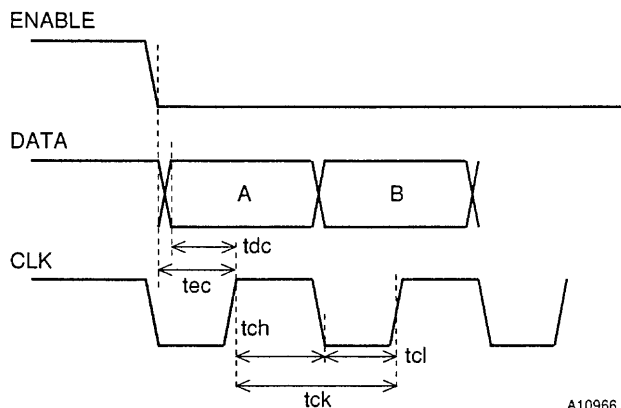

A10966

### Timing Characteristic

Parameter	Symbol	Ratings			Unit
		min	typ	max	
Enable-to-clock delay	$t_{ec}$	5			$\mu\text{s}$
Data-to-clock delay	$t_{dc}$	5			$\mu\text{s}$
Clock high-level hold time	$t_{ch}$	5			$\mu\text{s}$
Clock high-level hold time	$t_{cl}$	5			$\mu\text{s}$
Clock period	$t_{ck}$	10			$\mu\text{s}$

## Control Commands

A = L, B1 = L, B2 = L

- D1, D2, and D3: Function input switching. In CD and MD modes an output buffer is used, but the 6-dB amplifier output is used for tape, tuner, and EXT modes. The input impedance is 50 k $\Omega$ .
- D4, D5, and D6: Matrix mode switching and total through switching. The signal selected by the matrix is mixed to the left and right channels according to D10 and used to form the surround signal according to the D11 and D12 delay signal selection bits. In total through mode, the left and right signals are directly output with the matrix and graphic equalizer blocks bypassed to provide a high signal-to-noise ratio output.
- D7: Audio rejection on/off. When this bit is set to 1, L+R mode must be selected with D4, D5, and D6.
- D8: Microphone mixing on/off.
- D9: Key control interface on/off. The signal (BGM) set up by the matrix block is output from pin 6 and the signal processed by key control is mixed into the left and right channels by inputting it to pin 7.
- D10: Left and right channel bypass/matrix switching. When matrix is selected, monaural and karaoke multi-sound software L/R only modes can be set up.
- D11: Surround signal I/O (input: pin 32, output: pin 33) on/off.
- D12 and D13: Delay line signal input switching. When SW = B, the signal processed by key control can be input to the delay line.

A = L, B1 = H, B2 = L

- D1 and D2: Delay line output filter switching: A 5-kHz or higher low-pass filter cutoff frequency is recommended for delay times of 15 to 50 ms, and a 2-kHz low-pass filter for 100 and 120 ms delay times.
- D3, D4, and D5: Reverb volume switching. Since oscillation may occur at the 0 dB setting, always use a setting of -1 dB or lower.
- D6, D7, and D8: Delay time setting.
- D9: System muting on/off. Always use the system muting function (D9) when changing the delay time. Turning the muting function on and the off again initializes memory and prevents incorrect operation.
- D10: Left and right channel output (pins 20 and 21) muting on/off.
- D11: Front mix right channel phase switching. Selects whether the delayed signal is added into the right channel in phase or out of phase relative to the left channel.
- D12 and D13: Front mix level switching.

A = L, B1 = L, B2 = H

- D1, D2, and D3: Graphic equalizer bass boost/cut level setting.
- D4, D5, and D6: Graphic equalizer mid boost/cut level setting.
- D7, D8, and D9: Graphic equalizer treble boost/cut level setting.
- D10 and D11: Port output high/low level settings. When set to high, the corresponding port pin is pulled up to VDD through a 51-k $\Omega$  resistor, and when set to low, the pin is pulled down with an npn transistor (about 1 k $\Omega$ ).

A = L, B1 = H, B2 = H, D1 = L

- D2, D3, D4, D5, D6, D7, and D8: Left channel master volume setting.
- D9, D10, and D11: Record volume setting.

A = L, B1 = H, B2 = H, D1 = H

- D2, D3, D4, D5, D6, D7, and D8: Right channel master volume setting.
- D9: Record output signal switching. Selects function output or mixer output.
- D10 and D11: Record output on/off (muting). D10 controls the pin 2 and pin 52 outputs and D11 controls the pin 3 and 53 outputs.

## LV1110NM

### Control Command Examples

The LV1110M provides the following functions required in digital surround systems: matrix, delay line, reverb volume, front mix (level and phase switching), and a graphic equalizer. It also provides microphone echo, a key control interface, vocal track removal, and multi-sound software support functions and associated settings as karaoke functions. The tables present examples of commands that control these functions.

#### MODE 1

BYPASS1	A	B1	B2	D1	D2	D3	D4	D5	D6	D7	D8	D9	D10	D11	D12	D13
	L	H	L	L	L	L	L	L	L	L	L	L	L	L	L	L
	L	L	L	L	L	H	H	L	H	L	L	L	L	L	L	L
	L	H	L	H	L	L	L	L	L	L	L	L	H	H	L	L

Total Through

#### MODE 2

BYPASS2	A	B1	B2	D1	D2	D3	D4	D5	D6	D7	D8	D9	D10	D11	D12	D13
	L	H	L	L	L	L	L	L	L	L	L	L	L	L	L	L
	L	L	L	L	L	H	H	L	L	L	L	L	L	L	L	L
	L	H	L	H	L	L	L	L	L	L	L	L	H	H	L	L

Matrix Through

#### MODE 3

STADIUM1	A	B1	B2	D1	D2	D3	D4	D5	D6	D7	D8	D9	D10	D11	D12	D13
	L	H	L	L	L	L	L	L	L	L	L	L	L	L	L	L
	L	L	L	L	L	H	H	L	L	L	L	L	L	H	L	H
	L	H	L	H	L	L	H	H	H	L	H	H	H	H	L	H

L + R Delay 50 ms, Reverb -5 dB, Front add -5 dB: Inverted phase, 5 kHz LPF

#### MODE 4

HALL	A	B1	B2	D1	D2	D3	D4	D5	D6	D7	D8	D9	D10	D11	D12	D13
	L	H	L	L	L	L	L	L	L	L	L	L	L	L	L	L
	L	L	L	L	L	H	L	L	L	L	L	L	L	H	L	H
	L	H	L	H	L	L	H	H	L	H	L	H	H	H	L	H

L + R Delay 50 ms, Reverb -5 dB, Front add -5 dB: Inverted phase, 5 kHz LPF

#### MODE 5

STAGE	A	B1	B2	D1	D2	D3	D4	D5	D6	D7	D8	D9	D10	D11	D12	D13
	L	H	L	L	L	L	L	L	L	L	L	L	L	L	L	L
	L	L	L	L	L	H	L	L	H	L	L	L	L	H	L	H
	L	H	L	H	L	L	H	H	H	L	L	H	H	H	H	L

L - R Delay 40 ms, Reverb -5 dB, Front add -3 dB: Inverted phase, 5 kHz LPF

## LV1110NM

### MODE 6

DISCO	A	B1	B2	D1	D2	D3	D4	D5	D6	D7	D8	D9	D10	D11	D12	D13
	L	H	L	L	L	L	L	L	L	L	L	L	L	L	L	L
	L	L	L	L	L	H	L	L	H	L	L	L	L	H	L	H
	L	H	L	H	L	L	H	H	L	H	L	H	H	H	H	L

L – R Delay 25 ms, Reverb –5 dB, Front add –3 dB: Inverted phase, 5 kHz LPF

### MODE 7

LIVE	A	B1	B2	D1	D2	D3	D4	D5	D6	D7	D8	D9	D10	D11	D12	D13
	L	H	L	L	L	L	L	L	L	L	L	L	L	L	L	L
	L	L	L	L	L	H	L	L	L	L	L	L	L	H	L	H
	L	H	L	H	L	L	L	L	L	L	H	L	H	H	H	L

L – R Delay 25 ms, Reverb off, Front add –3 dB: Inverted phase, 5 kHz LPF

### MODE 8

MIC ECHO	A	B1	B2	D1	D2	D3	D4	D5	D6	D7	D8	D9	D10	D11	D12	D13
	L	H	L	L	L	L	L	L	L	L	L	L	L	L	L	L
	L	L	L	L	L	H	L	L	L	L	H	L	L	L	L	L
	L	H	L	H	H	H	H	L	H	H	L	H	H	L	H	H

MIC Mix: Echo, Delay 100 ms, Reverb –1 dB, Front add +3 dB: 2 kHz LPF

### MODE 9

MIC ECHO Vocal canceler	A	B1	B2	D1	D2	D3	D4	D5	D6	D7	D8	D9	D10	D11	D12	D13
	L	H	L	L	L	L	L	L	L	L	L	L	L	L	L	L
	L	L	L	L	L	H	L	L	L	H	H	L	H	L	L	L
	L	H	L	H	H	H	H	L	H	H	L	H	H	L	H	H

MIC Mix: Echo, Vocal Cancel, Delay 100 ms, Reverb –1 dB, Front add +3 dB: 2 kHz LPF

### MODE 10

MIC ECHO With the key control interface enabled	A	B1	B2	D1	D2	D3	D4	D5	D6	D7	D8	D9	D10	D11	D12	D13
	L	H	L	L	L	L	L	L	L	L	L	L	L	L	L	L
	L	L	L	L	L	H	L	L	L	L	H	L	L	L	L	L
	L	H	L	H	H	H	H	L	H	H	L	H	H	L	H	H

MIC Mix: Echo, Key Control Interface On, Delay 100 ms, Reverb –1 dB, Front add +3 dB: 2 kHz LPF

### MODE11

MIC ECHO Multi-sound software Left channel only	A	B1	B2	D1	D2	D3	D4	D5	D6	D7	D8	D9	D10	D11	D12	D13
	L	H	L	L	L	L	L	L	L	L	L	L	L	L	L	L
	L	L	L	L	L	H	L	H	L	L	H	L	H	L	L	L
	L	H	L	H	H	H	H	L	H	H	L	H	H	L	H	H

MIC Mix: Echo, Lch Only, Delay 100 ms, Reverb –1 dB, Front add +3 dB: 2 kHz LPF

Graphic equalizer level attenuation technique

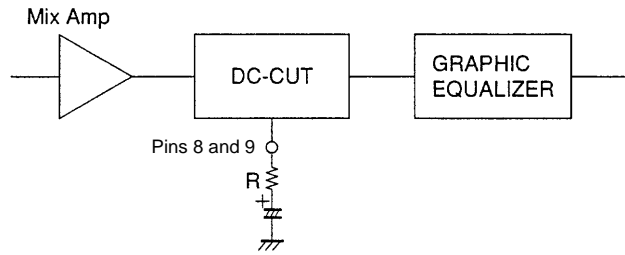

A11038

- Since the graphic equalizer provides a maximum boost of 10 dB, the head room is insufficient when this boost is used. Therefore, the signal level must be attenuated in the graphic equalizer block. One technique for providing this attenuation is to connect resistors in series with the external capacitors connected at pins 8 and 9 in the DC cut circuit. The formula below can be used to determine the amount of attenuation due to the value of the resistor.

Attenuation:  $V_G = 20 \times \log (1 - R/10 K + R)$  dB

Example: If  $R = 10 k\Omega$ , the attenuation will be  $-6$  dB.

Pin Functions

Pin No.	Pin Name	Pin voltage	Equivalent circuit	Description
1 54 55 56 57 58 61 62 63 64	EXT.R.IN CD.L.IN TAPE.L.IN TUNER.L.IN MD.L.IN EXT.L.IN CD.R.IN TAPE.R.IN TUNER.R.IN MD.R.IN	$1/2 V_{CC}$	<ul style="list-style-type: none"> <li>• Function input pins. A TAPE, TUNER, or EXT inputs passes through an internal 6-dB amplifier; a CD or MD input, through a buffer amplifier.</li> </ul>	<p>A10967</p>
2 3 52 53	REC.R.OUT1 REC.R.OUT2 REC.L.OUT1 REC.L.OUT2	$1/2 V_{CC}$	<ul style="list-style-type: none"> <li>• Recording output pins.</li> </ul>	<p>A10968</p>
4	MIC.IN	$1/2 V_{CC}$	<ul style="list-style-type: none"> <li>• Microphone mixer and echo input pin.</li> </ul>	<p>A10969</p>

Continued on next page.



# LV1110NM

Continued from preceding page.

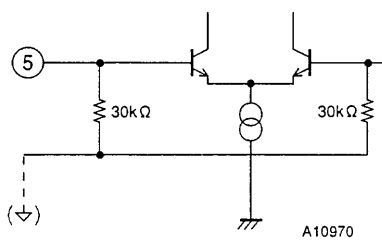
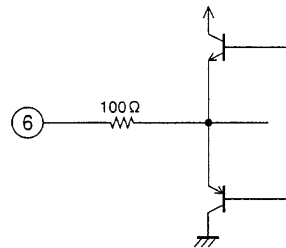
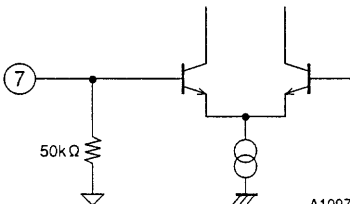
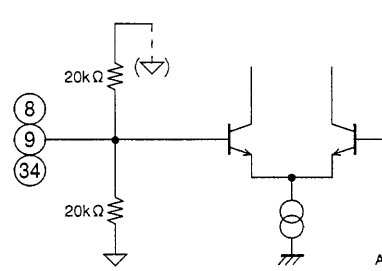
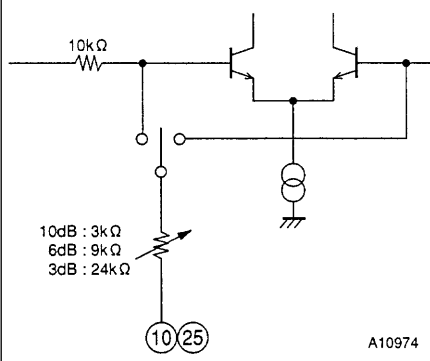
Pin No.	Pin Name	Pin voltage	Equivalent circuit	Description
5	VM.C	$1/2 V_{CC}$		<ul style="list-style-type: none"> <li>Pin for connecting phase shifter capacitor for karaoke functions and voice canceler.</li> </ul>  <p style="text-align: right;">A10970</p>
6	KEY/DELAY.OUT	$1/2 V_{CC}$		<ul style="list-style-type: none"> <li>Output pin for key control BGM output or delay signal.</li> </ul>  <p style="text-align: right;">A10971</p>
7	KEY.IN	$1/2 V_{CC}$		<ul style="list-style-type: none"> <li>Key control processing signal input pin.</li> </ul>  <p style="text-align: right;">A10972</p>
8 9 34	DC-CUT.R DC-CUT.L DC-CUT	$1/2 V_{CC}$		<ul style="list-style-type: none"> <li>Pins for connecting capacitors for DC-CUT function. The capacitances determine the low pass filter cutoff frequencies.</li> </ul>  <p style="text-align: right;">A10973</p>
10 25	HIGH.R HIGH.L	$1/2 V_{CC}$		<ul style="list-style-type: none"> <li>Pins for connecting TREBLE capacitors.</li> </ul>  <p style="text-align: right;">A10974</p>

Continued on next page.

# LV1110NM

Continued from preceding page.

Pin No.	Pin Name	Pin voltage	Equivalent circuit	Description
11 14 28 31	MID.RI LOW.RI MID.LI LOW.LI	$1/2 V_{CC}$	• Semiconductor inductance buffer amplifier input pins.	<p style="text-align: right;">A10975</p>
12 15 27 30	MID.RO LOW.RO MID.LO LOW.LO	$1/2 V_{CC}$	• Semiconductor inductance buffer amplifier output pins.	<p style="text-align: right;">A10976</p>
13 16 26 29	MID.R LOW.R MID.L LOW.L	$1/2 V_{CC}$	• Pins for connecting BASS/MID semiconductor inductances.	<p>10dB : 22kΩ 6dB : 8kΩ 3dB : 2.7kΩ</p> <p style="text-align: right;">A10977</p>
18 23	VOL.R.OUT VOL.L.OUT	$1/2 V_{CC}$	• Master volume control output pins.	<p style="text-align: right;">A10978</p>
19 22	VOL.R.IN VOL.L.IN	$1/2 V_{CC}$	• Master volume control input pins.	<p style="text-align: right;">A10979</p>

Continued on next page.

# LV1110NM

Continued from preceding page.

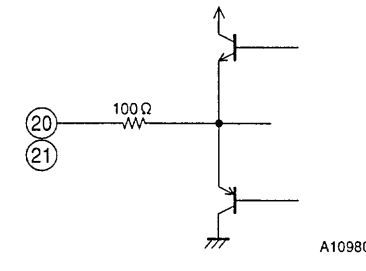
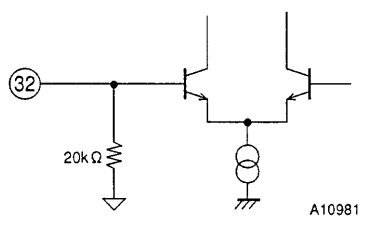
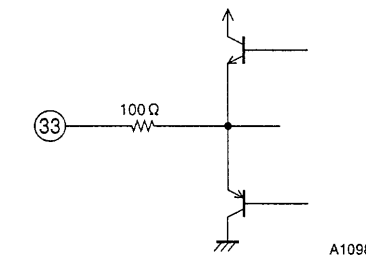
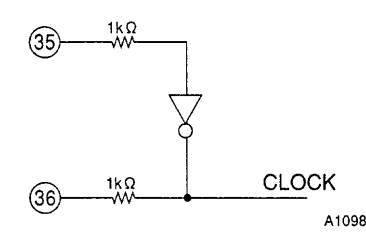
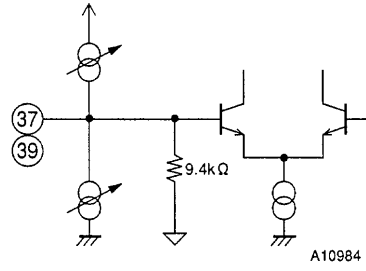
Pin No.	Pin Name	Pin voltage	Equivalent circuit	Description
20 21	OUT.R OUT.L	$1/2 V_{CC}$	• LINE OUT pins.	 <p style="text-align: right;">A10980</p>
32	S-IN	$1/2 V_{CC}$	• Surround signal input pin.	 <p style="text-align: right;">A10981</p>
33	S-OUT	$1/2 V_{CC}$	• Delay processing surround signal output pin.	 <p style="text-align: right;">A10982</p>
35 36	OSC1 OSC2	0/5 V	• Pins for connecting 8-MHz oscillator.	 <p style="text-align: right;">A10983</p>
37 39	D/A A/D	$1/2 V_{CC}$	• Pins for connecting variable integrator capacitors.	 <p style="text-align: right;">A10984</p>

Continued on next page.

# LV1110NM

Continued from preceding page.

Pin No.	Pin Name	Pin voltage	Equivalent circuit	Description
38	N.S	$1/2 V_{CC}$	• Pins for connecting noise shaper capacitor.	<p style="text-align: right;">A10985</p>
40	$V_{DD}$	5 V	• $V_{DD}$ output from internal power supply.	<p style="text-align: right;">A10986</p>
41 42 43 46	ENABLE DATA CLOCK SHUMIT.REF	$0/5 V$	• Serial control data input pins. Connect pin 46 to the Low level for the input data.	<p style="text-align: right;">A10987</p>
44 45	O.PORT2 O.PORT1	$0/5 V$	• Output port pins. 1-mA current at Low level. Sink pin voltage: approximately 1 V.	<p style="text-align: right;">A10988</p>
48 50	IN.L IN.R	$1/2 V_{CC}$	• LINE IN pins.	<p style="text-align: right;">A10989</p>
49 51	FUNCTION.L OUT FUNCTION.R OUT	$1/2 V_{CC}$		<p style="text-align: right;">A10990</p>

# LV1110NM

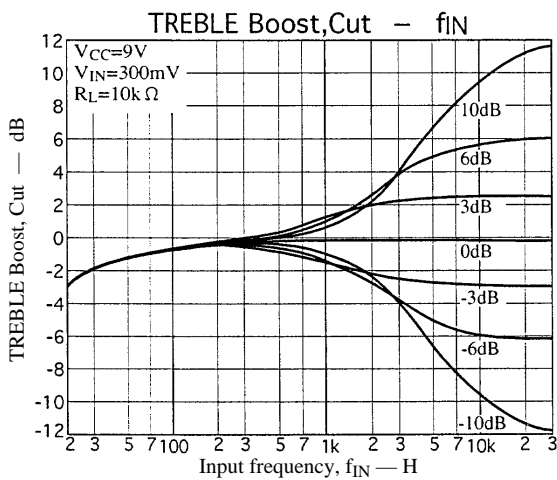
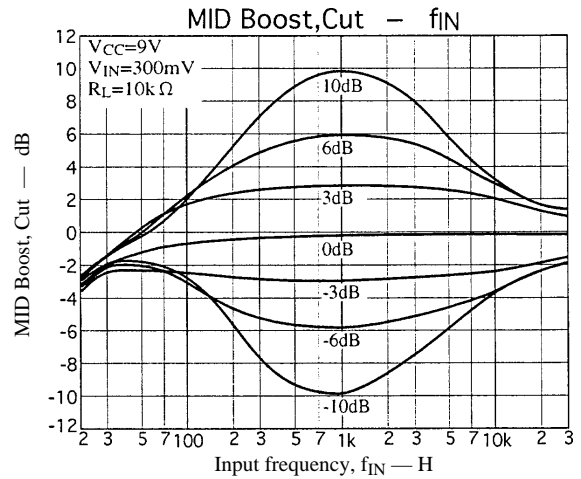
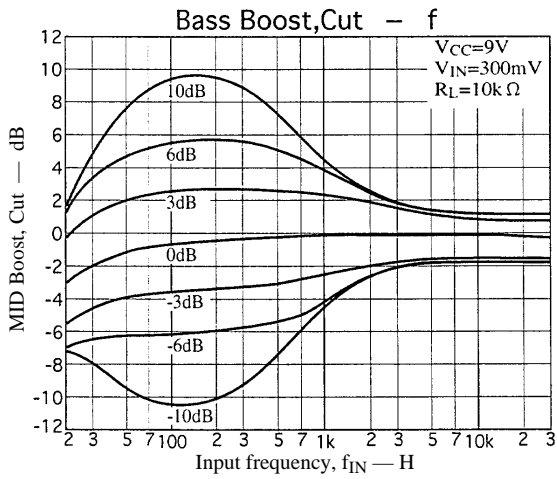
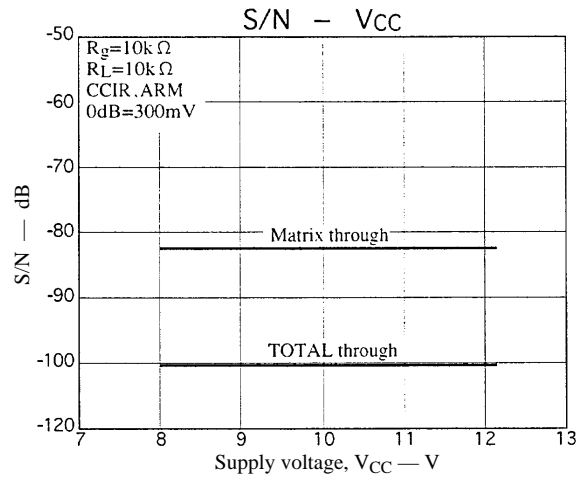
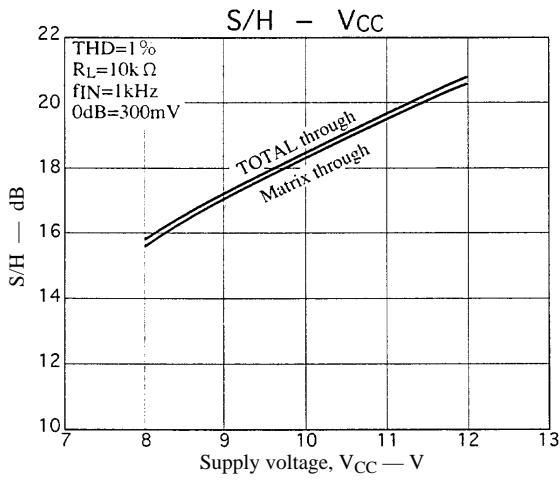
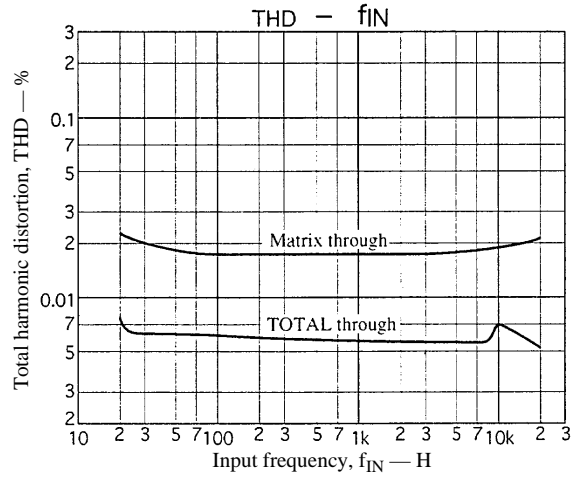
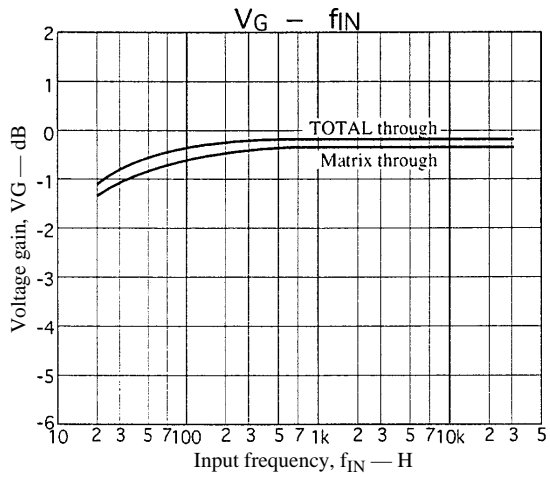

- Specifications of any and all SANYO products described or contained herein stipulate the performance, characteristics, and functions of the described products in the independent state, and are not guarantees of the performance, characteristics, and functions of the described products as mounted in the customer's products or equipment. To verify symptoms and states that cannot be evaluated in an independent device, the customer should always evaluate and test devices mounted in the customer's products or equipment.
- SANYO Electric Co., Ltd. strives to supply high-quality high-reliability products. However, any and all semiconductor products fail with some probability. It is possible that these probabilistic failures could give rise to accidents or events that could endanger human lives, that could give rise to smoke or fire, or that could cause damage to other property. When designing equipment, adopt safety measures so that these kinds of accidents or events cannot occur. Such measures include but are not limited to protective circuits and error prevention circuits for safe design, redundant design, and structural design.
- In the event that any or all SANYO products (including technical data, services) described or contained herein are controlled under any of applicable local export control laws and regulations, such products must not be exported without obtaining the export license from the authorities concerned in accordance with the above law.
- No part of this publication may be reproduced or transmitted in any form or by any means, electronic or mechanical, including photocopying and recording, or any information storage or retrieval system, or otherwise, without the prior written permission of SANYO Electric Co., Ltd.
- Any and all information described or contained herein are subject to change without notice due to product/technology improvement, etc. When designing equipment, refer to the "Delivery Specification" for the SANYO product that you intend to use.
- Information (including circuit diagrams and circuit parameters) herein is for example only; it is not guaranteed for volume production. SANYO believes information herein is accurate and reliable, but no guarantees are made or implied regarding its use or any infringements of intellectual property rights or other rights of third parties.

This catalog provides information as of November, 1998. Specifications and information herein are subject to change without notice.