

## P-Channel 30-V (D-S) MOSFET

### ■ Features

- Low  $r_{DS(on)}$  Provides Higher Efficiency and Extends Battery Life
- Miniature SO-8 Surface Mount Package Saves Board Space
- High power and current handling capability
- Extended  $V_{GS}$  range ( $\pm 25$ ) for battery pack applications

### ■ General Description

These miniature surface mount MOSFETs utilize High Cell Density process. Low  $r_{DS(on)}$  assures minimal power loss and conserves energy, making this device ideal for use in power management circuitry. Typical applications are PWMDC-DC converters, power management in portable and battery-powered products such as computers, printers, battery charger, telecommunication power system, and telephones power system.

### ■ Product Summary

$V_{DS}$ (V)	$r_{DS(on)}$ (m $\Omega$ )	$I_D$ (A)
-30	49@ $V_{GS}=-10V$	-5.7
	69@ $V_{GS}=-4.5V$	-5.0

### ■ Pin Assignments

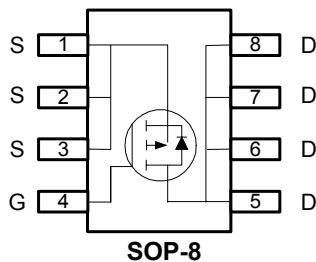

### ■ Pin Descriptions

Pin Name	Description
S	Source
G	Gate
D	Drain

### ■ Ordering information

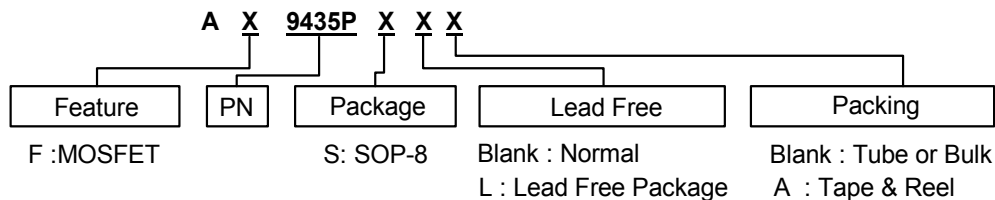



## P-Channel 30-V (D-S) MOSFET

### ■ Absolute Maximum Ratings ( $T_A=25^\circ\text{C}$ unless otherwise noted)

Symbol	Parameter	Rating	Units
$V_{DS}$	Drain-Source Voltage	-30	V
$V_{GS}$	Gate-Source Voltage	$\pm 25$	V
$I_D$	Continuous Drain Current (Note 1)	$T_A=25^\circ\text{C}$	$\pm 6.5$
		$T_A=70^\circ\text{C}$	$\pm 5.2$
$I_{DM}$	Pulsed Drain Current (Note 2)	$\pm 30$	A
$I_S$	Continuous Source Current (Diode Conduction) (Note 1)	-1.6	A
$P_D$	Power Dissipation (Note 1)	$T_A=25^\circ\text{C}$	3.1
		$T_A=70^\circ\text{C}$	2.0
$T_J, T_{STG}$	Operating Junction and Storage Temperature Range	-55 to 150	$^\circ\text{C}$

### ■ Thermal Resistance Ratings

Symbol	Parameter	Maximum	Units
$R_{\theta JC}$	Maximum Junction-to-Case (Note 1)	25	$^\circ\text{C/W}$
$R_{\theta JA}$	Maximum Junction-to-Ambient (Note 1)	40	$^\circ\text{C/W}$

Note 1: surface Mounted on 1"x 1" FR4 Board.

Note 2: Pulse width limited by maximum junction temperature

### ■ Specifications ( $T_A=25^\circ\text{C}$ unless otherwise noted)

Symbol	Parameter	Test Conditions	Limits			Unit
			Min.	Typ.	Max.	
<b>Static</b>						
$V_{(BR)DSS}$	Drain-Source breakdown Voltage	$V_{GS}=0V, I_D=-250\mu\text{A}$	-30	-	-	V
$V_{GS(th)}$	Gate-Threshold Voltage	$V_{DS}=V_{GS}, I_D=-250\mu\text{A}$	-1	-1.6	-3	V
$I_{GSS}$	Gate-Body Leakage	$V_{DS}=0V, V_{GS}=\pm 25V$	-	-	$\pm 100$	nA
$I_{DSS}$	Zero Gate Voltage Drain Current	$V_{DS}=-24V, V_{GS}=0V$	-	-	-1	uA
		$V_{DS}=-24V, V_{GS}=0V, T_J=55^\circ\text{C}$	-	-	-5	
$I_{D(on)}$	On-State Drain Current (Note 3)	$V_{DS}=-5V, V_{GS}=-10V$	-30	-	-	A
$r_{DS(on)}$	Drain-Source On-Resistance (Note 3)	$V_{GS}=-10V, I_D=-5.7A$	-	38	49	m $\Omega$
		$V_{GS}=-4.5V, I_D=-5.0A$	-	54	69	
		$V_{GS}=-10V, I_D=-5.7A, T_J=55^\circ\text{C}$	-	42	54	
$g_{fs}$	Forward Transconductance (Note 3)	$V_{DS}=-15V, I_D=-5.7A$	-	19	-	S
$V_{SD}$	Diode Forward Voltage	$I_S=-2.1A, V_{GS}=0V$	-	-0.7	-1.2	V
<b>Dynamic (Note 4)</b>						
$Q_g$	Total Gate Charge	$V_{DS}=-15V, V_{GS}=-4.5V, I_D=-5.7A$	-	6	11	nC
$Q_{gs}$	Gate-Source Charge		-	2.0	-	
$Q_{gd}$	Gate-Drain Charge		-	2.7	-	
<b>Switching</b>						
$t_{d(on)}$	Turn-On Delay Time	$V_{DD}=-15, R_L=15\Omega, I_D=-1A, V_{GEN}=-10V, R_G=6\Omega$	-	7	14	nS
$t_r$	Rise Time		-	13	24	
$t_{d(off)}$	Turn-Off Delay Time		-	14	25	
$t_f$	Fall-Time		-	9	17	

Note 3: Pulse test:  $PW \leq 300\mu\text{s}$  duty cycle  $\leq 2\%$ .

Note 4: Guaranteed by design, not subject to production testing.

## P-Channel 30-V (D-S) MOSFET

### Typical Performance Characteristics

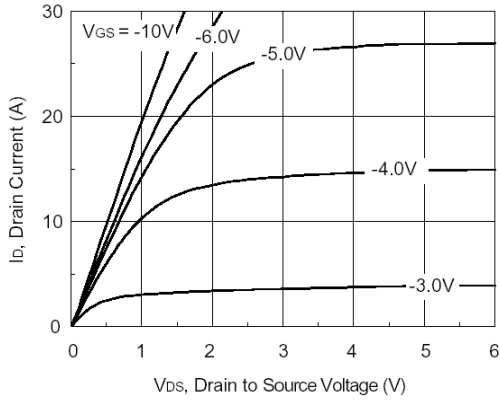

Figure 1. On-Region Characteristics

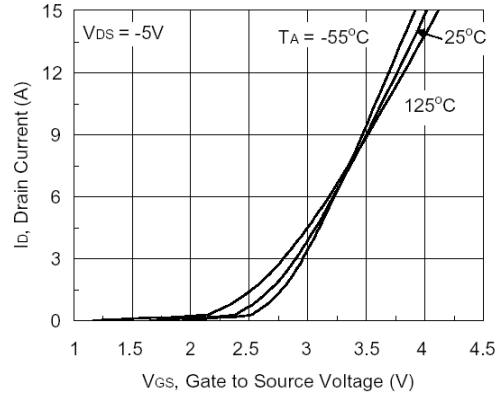

Figure 2. Body Diode Forward Voltage Variation with Source Current and Temperature

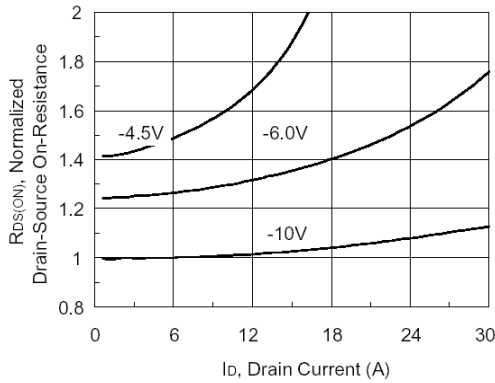

Figure 3. On Resistance Vs  $V_{GS}$  Voltage

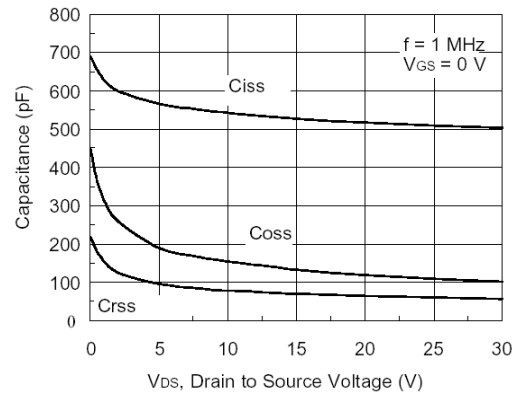

Figure 4. Capacitance Characteristics

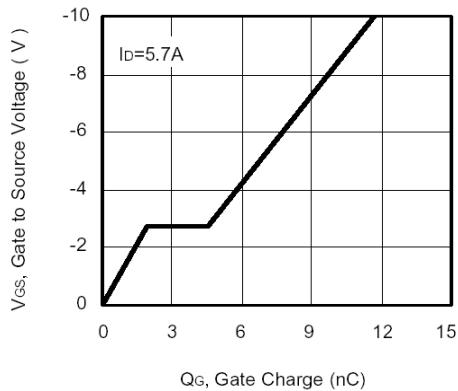

Figure 5. Gate Charge Characteristics

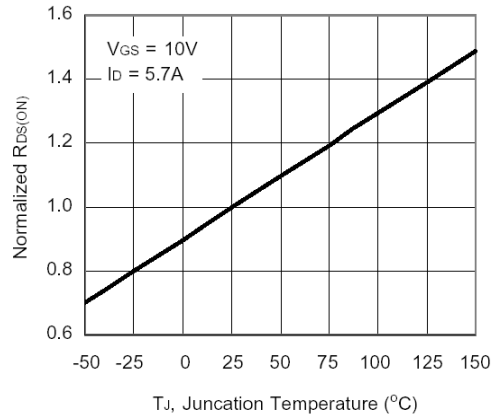

Figure 6. On-Resistance Variation with Temperature

## P-Channel 30-V (D-S) MOSFET

### ■ Typical Performance Characteristics

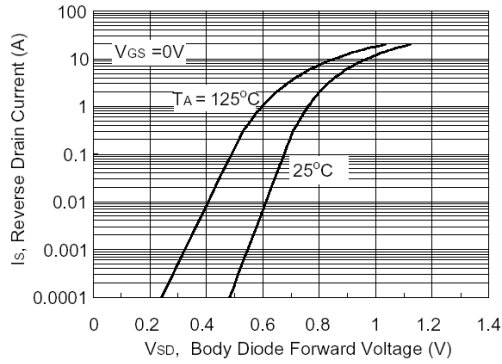

Figure 7. Transfer Characteristics

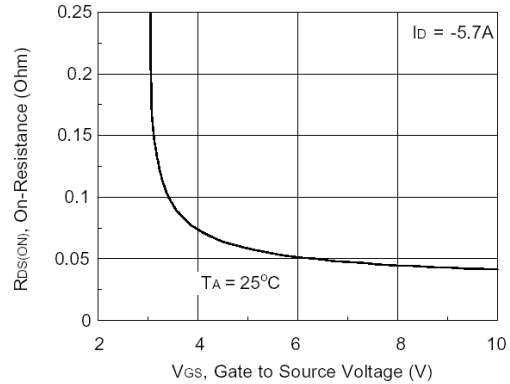

Figure 8. On-Resistance with Gate to Source Voltage

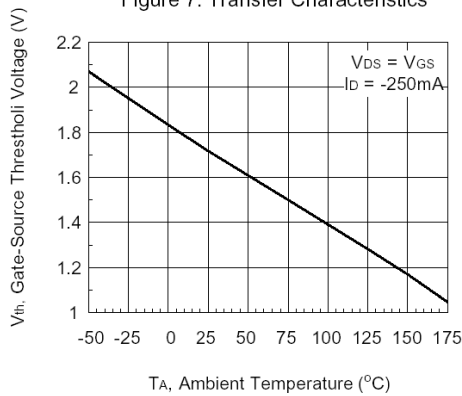

Figure 9. Vth Gate to Source Voltage v.s. Temperature

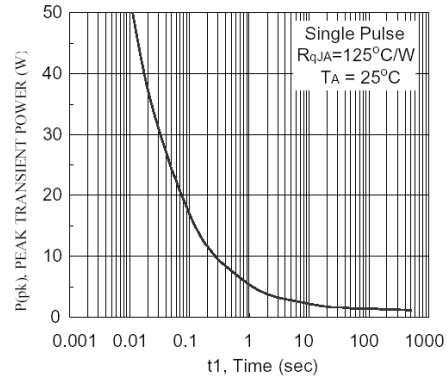

Figure 10. Single Pulse Maximum Power Dissipation

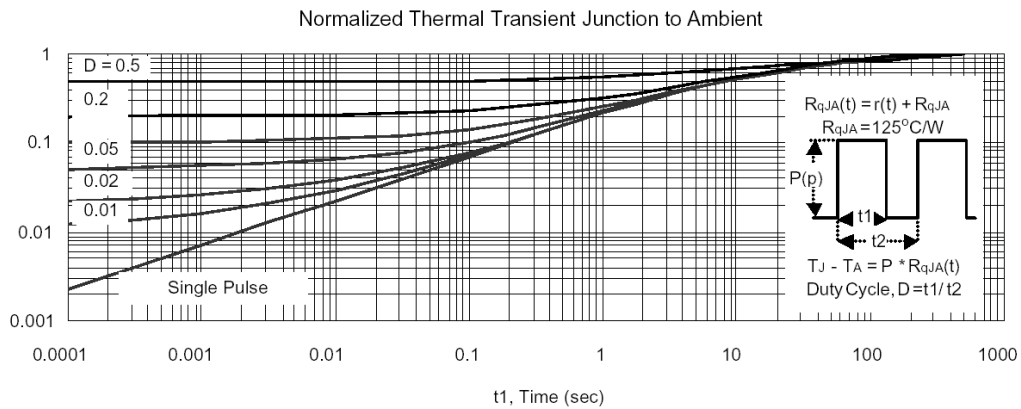
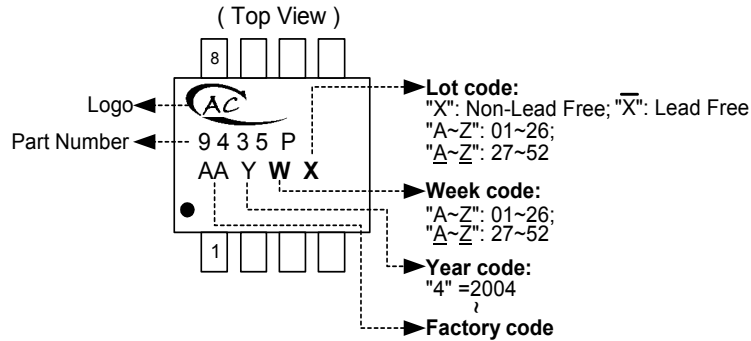

Figure 11. Transient Thermal Response Curve

## P-Channel 30-V (D-S) MOSFET

### ■ Marking Information

SOP-8L



### ■ Package Information

Package Type: SOP-8L

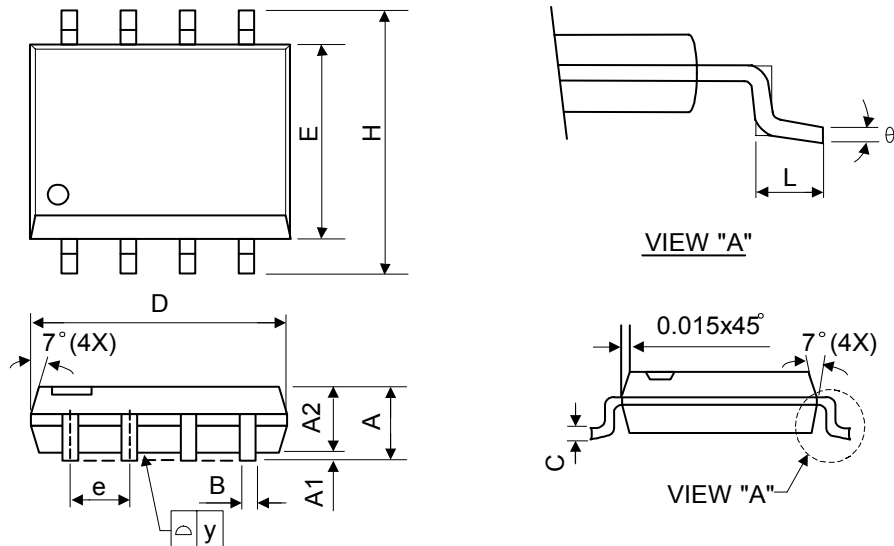

Symbol	Dimensions In Millimeters			Dimensions In Inches		
	Min.	Nom.	Max.	Min.	Nom.	Max.
A	1.40	1.60	1.75	0.055	0.063	0.069
A1	0.10	-	0.25	0.040	-	0.100
A2	1.30	1.45	1.50	0.051	0.057	0.059
B	0.33	0.41	0.51	0.013	0.016	0.020
C	0.19	0.20	0.25	0.0075	0.008	0.010
D	4.80	5.05	5.30	0.189	0.199	0.209
E	3.70	3.90	4.10	0.146	0.154	0.161
e	-	1.27	-	-	0.050	-
H	5.79	5.99	6.20	0.228	0.236	0.244
L	0.38	0.71	1.27	0.015	0.028	0.050
y	-	-	0.10	-	-	0.004
θ	0°	-	8°	0°	-	8°

This datasheet has been download from:

[www.datasheetcatalog.com](http://www.datasheetcatalog.com)

Datasheets for electronics components.