

AN7515SH

Audio signal processing IC for notebook PC

■ Overview

AN7515SH has a speaker power amplifier, head-phone power amplifier, line amplifier, electric volume and a bass boost circuit for notebook PC. This IC adopts a small thin package, enabling compact and high integrated set.

■ Features

- Possible speaker power is
 1 W × 2-ch. : 8 Ω output at $V_{CC} = 5\text{ V}$
 0.65 W × 2-ch. : 4 Ω output at $V_{CC} = 3.3\text{ V}$
- A gain and frequency response of bass boost can be adjusted with external components
- Each amplifiers has a standby and mute switch
- Pin compatible with AN7516SH with Spatializer function except for Spatializer pins
- V_{CC} of speaker and headphone can be adjusted separately
- Thin package (1.0 mm)

■ Applications

- Notebook PC

■ Block Diagram

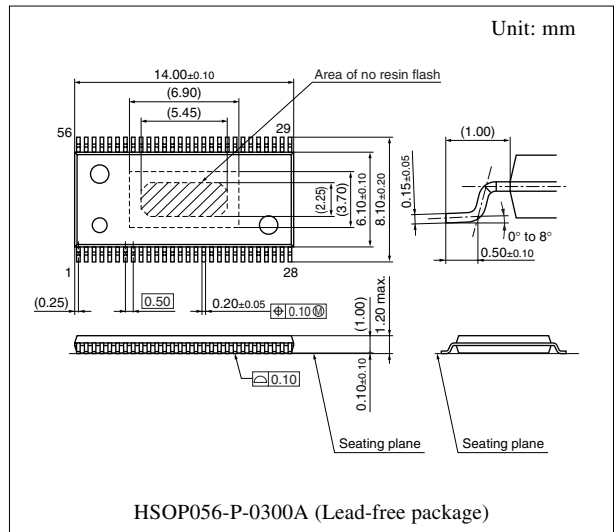
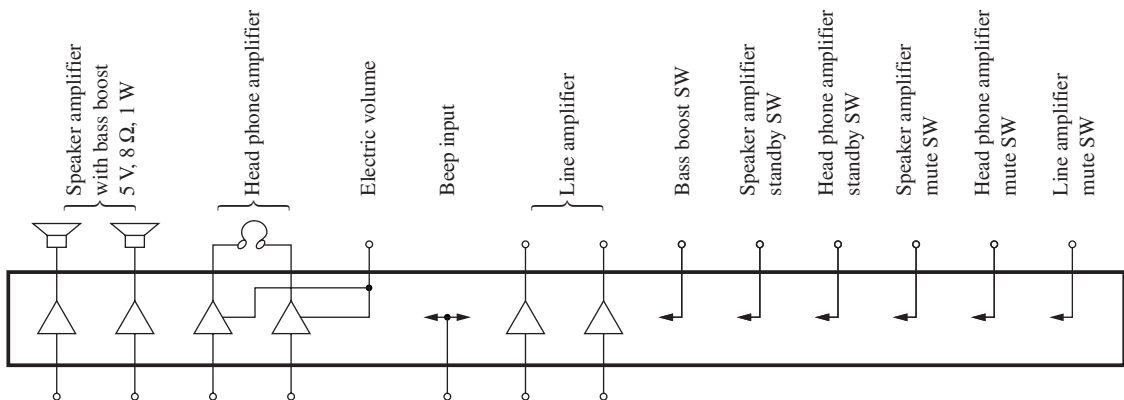

■ Pin Descriptions

Pin No.	Description	Pin No.	Description
1	Power supply (R-ch. speaker power use)	29	Line amplifier R-ch. output
2	R-ch. speaker output 1	30	GND (Line small signal use)
3	R-ch. speaker output 2	31	Line amplifier L-ch. output
4	N.C.	32	Beep control (Line)
5	GND (R-ch. SP power use)	33	Line mute control
6	Bass boost capacitor 1	34	Beep control (HP)
7	Speaker R-ch. input	35	HP mute control
8	Speaker L-ch. input	36	GND
9	Ripple filter (SP)	37	Ripple filter 1 (HP)
10	Power supply (Speaker small signal use)	38	GND (SP small signal use)
11	L-ch. headphone output	39	Volume control
12	R-ch. headphone output	40	Ripple filter 2 (HP)
13	GND (HP power use)	41	Standby (HP/Line)
14	GND (HP small signal use)	42	N.C.
15	N.C.	43	SP mute control
16	Power supply (HP power use)	44	Standby (SP)
17	Power supply (HP small signal use)	45	R1 for bass boost gain
18	N.C.	46	R2 for bass boost gain
19	N.C.	47	Bass boost capacitor 2
20	N.C.	48	Bass boost capacitor 3
21	N.C.	49	Bass boost capacitor 4
22	Beep input	50	Bass boost limit control
23	N.C.	51	Bass boost control
24	Headphone R-ch. input 2	52	GND (L-ch. SP power use)
25	Headphone L-ch. input 1	53	N.C.
26	N.C.	54	L-ch. speaker output 2
27	Line amplifier L-ch. input	55	L-ch. speaker output 1
28	Line amplifier R-ch. input	56	Power supply (L-ch. speaker power use)

■ Absolute Maximum Ratings

Parameter	Symbol	Rating	Unit
Supply voltage *2	V_{CC}	5.75	V
Supply current	I_{CC}	1 200	mA
Power dissipation *3	P_D	0.628	W
Operating ambient temperature *1	T_{opr}	-25 to +75	°C
Storage temperature *1	T_{stg}	-55 to +150	°C

Note) *1: Except for the operating ambient temperature and storage temperature, all ratings are for $T_a = 25^\circ\text{C}$.

*2: Without signal

*3: $T_a = 75^\circ\text{C}$, mounted on standard board.

■ Recommended Operating Range

Parameter	Symbol	Range	Unit
Supply voltage	V_{CC}	3.0 to 5.5	V

■ Electrical Characteristics at $T_a = 25^\circ\text{C}$, $f = 1\text{ kHz}$

Parameter	Symbol	Conditions	Min	Typ	Max	Unit
Quiescent circuit current 1	I_{T1}	Current of $V_{CC1(SP)}$, $V_{CC2(SP)}$, $V_{CC3(SP)} = 5\text{ V}/(\text{No load})$	—	7.5	13.1	mA
Quiescent circuit current 2	I_{T2}	Current of $V_{CC1(HP)}$, $V_{CC2(HP)} = 5\text{ V}/(\text{No load})$	—	6.0	10.0	mA
Standby current 1	I_{ST1}	STB: On current of $V_{CC1(SP)}$, $V_{CC2(SP)}$, $V_{CC3(SP)} = 5\text{ V}$	—	0.1	50	μA
Standby current 2	I_{ST2}	STB: On current of $V_{CC1(HP)}$, $V_{CC2(HP)} = 5\text{ V}$	—	0.1	50	μA

Speaker amplifier ($R_L = 8\ \Omega$)

L-ch. output voltage level *1	V_{SPL}	$V_{IN} = -10\text{ dBV}$, $R_L = 8\ \Omega$ $V_{CC1(SP)}$, $V_{CC2(SP)}$, $V_{CC3(SP)} = 5\text{ V}$	1.5	4.0	6.5	dBV
R-ch. output voltage level *1	V_{SPR}	$V_{IN} = -10\text{ dBV}$, $R_L = 8\ \Omega$ $V_{CC1(SP)}$, $V_{CC2(SP)}$, $V_{CC3(SP)} = 5\text{ V}$	1.5	4.0	6.5	dBV
L-ch. total harmonic distortion *1	TH_{SL}	$V_{IN} = -10\text{ dBV}$, $R_L = 8\ \Omega$ $V_{CC1(SP)}$, $V_{CC2(SP)}$, $V_{CC3(SP)} = 5\text{ V}$	—	0.2	0.5	%
R-ch. total harmonic distortion *1	TH_{SR}	$V_{IN} = -10\text{ dBV}$, $R_L = 8\ \Omega$ $V_{CC1(SP)}$, $V_{CC2(SP)}$, $V_{CC3(SP)} = 5\text{ V}$	—	0.2	0.5	%
L-ch. max. output level *1	V_{MAXSL}	THD = 10%, $f = 1\text{ kHz}$ $V_{CC1(SP)}$, $V_{CC2(SP)}$, $V_{CC3(SP)} = 5\text{ V}$	7.0	9.0	—	dBV
R-ch. max. output level *1	V_{MAXSR}	THD = 10%, $f = 1\text{ kHz}$ $V_{CC1(SP)}$, $V_{CC2(SP)}$, $V_{CC3(SP)} = 5\text{ V}$	7.0	9.0	—	dBV
L-ch. max. output level 1 *1	V_{MAXS1L}	THD = 10%, $R_L = 4\ \Omega$, $f = 1\text{ kHz}$ $V_{CC1(SP)}$, $V_{CC2(SP)}$, $V_{CC3(SP)} = 3.3\text{ V}$	2.0	4.0	—	dBV
R-ch. max. output level 1 *1	V_{MAXS1R}	THD = 10%, $R_L = 4\ \Omega$, $f = 1\text{ kHz}$ $V_{CC1(SP)}$, $V_{CC2(SP)}$, $V_{CC3(SP)} = 3.3\text{ V}$	2.0	4.0	—	dBV
L-ch. output noise voltage *2	V_{NSL}	$R_g = 1\text{ k}\Omega$ $V_{CC1(SP)}$, $V_{CC2(SP)}$, $V_{CC3(SP)} = 5\text{ V}$	—	-80	-70	dBV

Note) *1: DIN audio filter is used.

*2: A-curve filter is used.

■ Electrical Characteristics at $T_a = 25^\circ\text{C}$, $f = 1\text{ kHz}$ (continued)

Parameter	Symbol	Conditions	Min	Typ	Max	Unit
Speaker amplifier (continued) ($R_L = 8\ \Omega$)						
R-ch. output noise voltage *2	V_{NSR}	$R_g = 1\ \text{k}\Omega$ $V_{CC1(SP)}, V_{CC2(SP)}, V_{CC3(SP)} = 5\ \text{V}$	—	-80	-70	dBV
L-ch. output offset voltage	V_{OFSL}	$R_g = 0\ \Omega$ $V_{CC1(SP)}, V_{CC2(SP)}, V_{CC3(SP)} = 5\ \text{V}$	-100	0	100	mV
R-ch. output offset voltage	V_{OFSR}	$R_g = 0\ \Omega$ $V_{CC1(SP)}, V_{CC2(SP)}, V_{CC3(SP)} = 5\ \text{V}$	-100	0	100	mV
Channel balance	CHB_S	$V_{IN} = -10\ \text{dBV}$, $R_L = 8\ \Omega$ $V_{CC1(SP)}, V_{CC2(SP)}, V_{CC3(SP)} = 5\ \text{V}$	-1	0	1	dB
L-ch. crosstalk *1	CT_{LSLR}	$V_{IN} = -10\ \text{dBV}$, $R_L = 8\ \Omega$ $V_{CC1(SP)}, V_{CC2(SP)}, V_{CC3(SP)} = 5\ \text{V}$	70	80	—	dB
R-ch. crosstalk *1	CT_{LSRL}	$V_{IN} = -10\ \text{dBV}$, $R_L = 8\ \Omega$ $V_{CC1(SP)}, V_{CC2(SP)}, V_{CC3(SP)} = 5\ \text{V}$	70	80	—	dB
L-ch. mute attenuation *1	V_{MUSL}	$V_{IN} = -10\ \text{dBV}$, $R_L = 8\ \Omega$ $V_{CC1(SP)}, V_{CC2(SP)}, V_{CC3(SP)} = 5\ \text{V}$	70	80	—	dB
R-ch. mute attenuation *1	V_{MUSR}	$V_{IN} = -10\ \text{dBV}$, $R_L = 8\ \Omega$ $V_{CC1(SP)}, V_{CC2(SP)}, V_{CC3(SP)} = 5\ \text{V}$	70	80	—	dB
Headphone amplifier ($R_L = 32\ \Omega$)						
L-ch. output voltage level *1	V_{HPL}	$V_{IN} = -10\ \text{dBV}$, $R_L = 32\ \Omega$ $V_{CC1(HP)}, V_{CC2(HP)} = 5\ \text{V}$	-8.4	-5.0	-2.5	dBV
R-ch. output voltage level *1	V_{HPR}	$V_{IN} = -10\ \text{dBV}$, $R_L = 32\ \Omega$ $V_{CC1(HP)}, V_{CC2(HP)} = 5\ \text{V}$	-8.4	-5.0	-2.5	dBV
L-ch. total harmonic distortion *1	TH_{HL}	$V_{OUT} = 0\ \text{dBV}$, $R_L = 10\ \text{k}\Omega$ $V_{CC1(HP)}, V_{CC2(HP)} = 5\ \text{V}$	—	0.03	0.1	%
R-ch. total harmonic distortion *1	TH_{HR}	$V_{OUT} = 0\ \text{dBV}$, $R_L = 10\ \text{k}\Omega$ $V_{CC1(HP)}, V_{CC2(HP)} = 5\ \text{V}$	—	0.03	0.1	%
L-ch. max. output level *1	V_{MAHL5}	$THD = 1\%$, $R_L = 10\ \text{k}\Omega$ $V_{CC1(HP)}, V_{CC2(HP)} = 5\ \text{V}$	0.0	—	—	dBV
R-ch. max. output level *1	V_{MAHR5}	$THD = 1\%$, $R_L = 10\ \text{k}\Omega$ $V_{CC1(HP)}, V_{CC2(HP)} = 5\ \text{V}$	0.0	—	—	dBV
L-ch. max. output level 1 *1	V_{MAHL3}	$THD = 1\%$, $R_L = 10\ \text{k}\Omega$ $V_{CC1(HP)}, V_{CC2(HP)} = 3.3\ \text{V}$	-3.0	—	—	dBV
R-ch. max. output level 1 *1	V_{MAHR3}	$THD = 1\%$, $R_L = 10\ \text{k}\Omega$ $V_{CC1(HP)}, V_{CC2(HP)} = 3.3\ \text{V}$	-3.0	—	—	dBV
L-ch. output noise voltage *2	V_{NHL}	$R_g = 1\ \text{k}\Omega$ $V_{CC1(HP)}, V_{CC2(HP)} = 5\ \text{V}$	—	-90	-80	dBV
R-ch. output noise voltage *2	V_{NHR}	$R_g = 1\ \text{k}\Omega$ $V_{CC1(HP)}, V_{CC2(HP)} = 5\ \text{V}$	—	-90	-80	dBV
Channel balance	CHB_H	$V_{IN} = -10\ \text{dBV}$, $R_L = 32\ \Omega$ $V_{CC1(HP)}, V_{CC2(HP)} = 5\ \text{V}$	-2	0	2	dB

Note) *1: DIN audio filter is used.

*2: A-curve filter is used.

■ Electrical Characteristics at $T_a = 25^\circ\text{C}$, $f = 1\text{ kHz}$ (continued)

Parameter	Symbol	Conditions	Min	Typ	Max	Unit
Headphone amplifier (continued) ($R_L = 32\ \Omega$)						
L-ch. crosstalk *1	CT_{LHLR}	$V_{IN} = -10\ \text{dBV}$, $R_L = 32\ \Omega$ $V_{CC1(HP)}$, $V_{CC2(HP)} = 5\ \text{V}$	70	80	—	dB
R-ch. crosstalk *1	CT_{LHRL}	$V_{IN} = -10\ \text{dBV}$, $R_L = 32\ \Omega$ $V_{CC1(HP)}$, $V_{CC2(HP)} = 5\ \text{V}$	70	80	—	dB
L-ch. mute attenuation *1	V_{MUHL}	$V_{IN} = -10\ \text{dBV}$, $R_L = 32\ \Omega$ $V_{CC1(HP)}$, $V_{CC2(HP)} = 5\ \text{V}$	70	80	—	dB
R-ch. mute attenuation *1	V_{MUHR}	$V_{IN} = -10\ \text{dBV}$, $R_L = 32\ \Omega$ $V_{CC1(HP)}$, $V_{CC2(HP)} = 5\ \text{V}$	70	80	—	dB
Volume						
L-ch. middle voltage gain *1	VOL_L	$V_{IN} = -20\ \text{dBV}$, $V_{ol} = 1/2\ V_{CC}$ $V_{CC1(HP)}$, $V_{CC2(HP)} = 5\ \text{V}$	-37	-34.5	-32	dBV
R-ch. middle voltage gain *1	VOL_R	$V_{IN} = -20\ \text{dBV}$, $V_{ol} = 1/2\ V_{CC}$ $V_{CC1(HP)}$, $V_{CC2(HP)} = 5\ \text{V}$	-37	-34.5	-32	dBV
Middle channel balance	V_{CHB}	$V_{IN} = -20\ \text{dBV}$, $V_{ol} = 1/2\ V_{CC}$ $V_{CC1(HP)}$, $V_{CC2(HP)} = 5\ \text{V}$	-2	0	2	dB
L-ch. volume attenuation *1	VOL_{NL}	$V_{IN} = -10\ \text{dBV}$, $V_{ol} = 0\ \text{V}$ $V_{CC1(HP)}$, $V_{CC2(HP)} = 5\ \text{V}$	70	80	—	dB
R-ch. volume attenuation *1	VOL_{NR}	$V_{IN} = -10\ \text{dBV}$, $V_{ol} = 0\ \text{V}$ $V_{CC1(HP)}$, $V_{CC2(HP)} = 5\ \text{V}$	70	80	—	dB
Line amplifier						
L-ch. output voltage level *1	V_{HLL}	$V_{IN} = -10\ \text{dBV}$, $R_L = 10\ \text{k}\Omega$ $V_{CC1(HP)}$, $V_{CC2(HP)} = 5\ \text{V}$	-6.0	-4.0	-2.0	dBV
R-ch. output voltage level *1	V_{HLR}	$V_{IN} = -10\ \text{dBV}$, $R_L = 10\ \text{k}\Omega$ $V_{CC1(HP)}$, $V_{CC2(HP)} = 5\ \text{V}$	-6.0	-4.0	-2.0	dBV
L-ch. total harmonic distortion *1	TH_{LL}	$V_{IN} = -10\ \text{dBV}$, $R_L = 10\ \text{k}\Omega$ $V_{CC1(HP)}$, $V_{CC2(HP)} = 5\ \text{V}$	—	0.01	0.03	%
R-ch. total harmonic distortion *1	TH_{LR}	$V_{IN} = -10\ \text{dBV}$, $R_L = 10\ \text{k}\Omega$ $V_{CC1(HP)}$, $V_{CC2(HP)} = 5\ \text{V}$	—	0.01	0.03	%
L-ch. max. output level *1	V_{MALL5}	THD = 1%, $R_L = 10\ \text{k}\Omega$ $V_{CC1(HP)}$, $V_{CC2(HP)} = 5\ \text{V}$	0.0	—	—	dBV
R-ch. max. output level *1	V_{MALR5}	THD = 1%, $R_L = 10\ \text{k}\Omega$ $V_{CC1(HP)}$, $V_{CC2(HP)} = 5\ \text{V}$	0.0	—	—	dBV
L-ch. max. output level 1 *1	V_{MALL3}	THD = 1%, $R_L = 10\ \text{k}\Omega$ $V_{CC1(HP)}$, $V_{CC2(HP)} = 3.3\ \text{V}$	-3.0	—	—	dBV
R-ch. max. output level 1 *1	V_{MALR3}	THD = 1%, $R_L = 10\ \text{k}\Omega$ $V_{CC1(HP)}$, $V_{CC2(HP)} = 3.3\ \text{V}$	-3.0	—	—	dBV
L-ch. output noise voltage *2	V_{NLL}	$R_g = 1\ \text{k}\Omega$ $V_{CC1(HP)}$, $V_{CC2(HP)} = 5\ \text{V}$	—	-100	-90	dBV
R-ch. output noise voltage *2	V_{NLR}	$R_g = 1\ \text{k}\Omega$ $V_{CC1(HP)}$, $V_{CC2(HP)} = 5\ \text{V}$	—	-100	-90	dBV

Note) *1: DIN audio filter is used.

*2: A-curve filter is used.

■ Electrical Characteristics at $T_a = 25^\circ\text{C}$, $f = 1\text{ kHz}$ (continued)

Parameter	Symbol	Conditions	Min	Typ	Max	Unit
Line amplifier (continued)						
Channel balance	CHB _L	$V_{IN} = -10\text{ dBV}$, $R_L = 10\text{ k}\Omega$ $V_{CC1(HP)}$, $V_{CC2(HP)} = 5\text{ V}$	-1	0	1	dB
L-ch. crosstalk *1	CT _{LLLR}	$V_{IN} = -10\text{ dBV}$, $R_L = 10\text{ k}\Omega$ $V_{CC1(HP)}$, $V_{CC2(HP)} = 5\text{ V}$	70	80	—	dB
R-ch. crosstalk *1	CT _{LLRL}	$V_{IN} = -10\text{ dBV}$, $R_L = 10\text{ k}\Omega$ $V_{CC1(HP)}$, $V_{CC2(HP)} = 5\text{ V}$	70	80	—	dB
L-ch. mute attenuation *1	V _{MUHL}	$V_{IN} = -10\text{ dBV}$, $R_L = 10\text{ k}\Omega$ $V_{CC1(HP)}$, $V_{CC2(HP)} = 5\text{ V}$	70	80	—	dB
R-ch. mute attenuation *1	V _{MUHR}	$V_{IN} = -10\text{ dBV}$, $R_L = 10\text{ k}\Omega$ $V_{CC1(HP)}$, $V_{CC2(HP)} = 5\text{ V}$	70	80	—	dB
Switching level						
HP mute on	HMU _{ON}		GND	—	0.8	V
HP mute off	HMU _{OF}		2.0	—	5.5	V
HP standby on	HST _{ON}		GND	—	0.8	V
HP standby off	HST _{OF}		2.0	—	5.5	V
SP mute on	SMU _{ON}		GND	—	0.8	V
SP mute off	SMU _{OF}		2.0	—	5.5	V
SP standby on	SST _{ON}		GND	—	0.8	V
SP standby off	SST _{OF}		2.0	—	5.5	V
Bass boost off	BAS _{OF}		GND	—	0.8	V
Bass boost on	BAS _{ON}		2.0	—	5.5	V

Note) *1: DIN audio filter is used.

*2: A-curve filter is used.

• Design reference data

Note) The characteristics listed below are theoretical values based on the IC design and are not guaranteed.

Parameter	Symbol	Conditions	Min	Typ	Max	Unit
L-ch. ripple rejection (Speaker amplifier) *1	RJ _{SPL}	$f_r = 1\text{ kHz}$, $V_r = -20\text{ dBV}$ $V_{CC1(SP)}$, $V_{CC2(SP)}$, $V_{CC3(SP)} = 5\text{ V}$	30	40	—	dB
R-ch. ripple rejection (Speaker amplifier) *1	RJ _{SPR}	$f_r = 1\text{ kHz}$, $V_r = -20\text{ dBV}$ $V_{CC1(SP)}$, $V_{CC2(SP)}$, $V_{CC3(SP)} = 5\text{ V}$	30	40	—	dB
L-ch. ripple rejection (Headphone amplifier) *1	RJ _{HPL}	$f_r = 1\text{ kHz}$, $V_r = -20\text{ dBV}$ $V_{CC1(HP)}$, $V_{CC2(HP)} = 5\text{ V}$	30	40	—	dB
R-ch. ripple rejection (Headphone amplifier) *1	RJ _{HPR}	$f_r = 1\text{ kHz}$, $V_r = -20\text{ dBV}$ $V_{CC1(HP)}$, $V_{CC2(HP)} = 5\text{ V}$	30	40	—	dB
L-ch. ripple rejection (Line amplifier) *1	RJ _{LIL}	$f_r = 1\text{ kHz}$, $V_r = -20\text{ dBV}$ $V_{CC1(HP)}$, $V_{CC2(HP)} = 5\text{ V}$	30	40	—	dB
R-ch. ripple rejection (Line amplifier) *1	RJ _{LIR}	$f_r = 1\text{ kHz}$, $V_r = -20\text{ dBV}$ $V_{CC1(HP)}$, $V_{CC2(HP)} = 5\text{ V}$	30	40	—	dB

Note) *1: DIN audio filter is used.

Terminal Equivalent Circuits

Pin No.	Equivalent circuit	Description	Voltage
1	—	VCCRSP: R-ch. speaker amplifier power supply pin	5 V
2		SPOR1: R-ch. speaker amplifier output pin 1	2.3 V
3		SPOR2: R-ch. speaker amplifier output pin 2	2.3 V
4	—	N.C.	—
5	—	GNDRSP: Ground pin for the power of R-ch. speaker amplifier	0 V
6		BASSC1: Pin for the capacitor 1 connected to the LPF output at the 1st stage of bass boost	2.3 V

■ Terminal Equivalent Circuits (continued)

Pin No.	Equivalent circuit	Description	Voltage
7		<p>SPINR: Speaker amplifier R-ch. input pin</p>	2.3 V
8		<p>SPINL: Speaker amplifier L-ch. input pin</p>	2.3 V
9		<p>RFSP: Speaker amplifier ripple filter pin</p>	4.9 V
10	—	<p>VCCSSP: Speaker amplifier small signal power supply pin</p>	5 V
11		<p>HPOL: L-ch. headphone amplifier output pin</p>	2.15 V

■ Terminal Equivalent Circuits (continued)

Pin No.	Equivalent circuit	Description	Voltage
12		HPOR: R-ch. headphone amplifier output pin	2.15 V
13	—	GNDPHP: Ground pin for the power of head- phone amplifier	0 V
14	—	GNDSHP: Ground pin for the headphone ampli- fier small signal	0 V
15	—	N.C.	—
16	—	VCCPHP: Headphone amplifier power supply pin	5 V
17	—	VCCSHP: Headphone amplifier small signal power supply pin	5 V
18	—	N.C.	—
19	—	N.C.	—
20	—	N.C.	—
21	—	N.C.	—
22		BEEPIN: Beep input pin	1.0 V
23	—	N.C.	—

■ Terminal Equivalent Circuits (continued)

Pin No.	Equivalent circuit	Description	Voltage
24		HPINR2: Headphone amplifier R-ch. input pin 2	1.4 V
25		HPINL1: Headphone amplifier L-ch. input pin 1	1.4 V
26	—	N.C.	—
27		LINEINL: Line amplifier L-ch. input pin	2.5 V
28		LINEINR: Line amplifier R-ch. input pin	2.5 V

■ Terminal Equivalent Circuits (continued)

Pin No.	Equivalent circuit	Description	Voltage
29		<p>LINEOUTR: Line amplifier R-ch. output pin</p>	2.5 V
30	—	<p>LINEGND: Ground pin for line amplifier</p>	0 V
31		<p>LINEOUTL: Line amplifier L-ch. output pin</p>	2.5 V
32		<p>BEEPCL: Line amplifier beep output control pin</p>	0.1 V
33		<p>LINEMU: Line amplifier mute control pin</p>	—

■ Terminal Equivalent Circuits (continued)

Pin No.	Equivalent circuit	Description	Voltage
34		BEEPCH: Headphone amplifier beep output control pin	0.1 V
35		MUTEHP: Headphone amplifier mute control pin	—
36	—	GND	—
37		RFHP: Headphone amplifier ripple filter pin	4.9 V
38	—	GNDSSP: Ground pin for the speaker amplifier small signal	0 V
39		VOLC: Volume control pin	—

■ Terminal Equivalent Circuits (continued)

Pin No.	Equivalent circuit	Description	Voltage
40		RFLINE: Line amplifier ripple filter pin	4.9 V
41		STAHPLI: Headphone amplifier/line amplifier standby pin	—
42	—	N.C.	—
43		MUTESP: Speaker amplifier mute control pin	—
44		STASP: Speaker amplifier standby pin	—
45, 46		BASSR1, BASSR2: Bass boost gain setting pins	2.3 V

■ Terminal Equivalent Circuits (continued)

Pin No.	Equivalent circuit	Description	Voltage
47		<p>BASSC2: Pin for the capacitor 2 connected to the LPF output at the 2nd stage of bass boost</p>	2.3 V
48, 49		<p>BASSD1, BASSD2: Bass boost capacitor connection pins</p>	2.3 V
50		<p>BASSLIM: Bass boost limit level control pin</p>	0.1 V
51		<p>BASSSW: Bass boost on/off switch pin</p>	—
52	—	<p>GNDLSP: Ground pin for the power of L-ch. speaker amplifier</p>	0 V

■ Terminal Equivalent Circuits (continued)

Pin No.	Equivalent circuit	Description	Voltage
53	—	N.C.	—
54		SPOL1: L-ch. speaker amplifier output pin 2	2.3 V
55		SPOL2: L-ch. speaker amplifier output pin 1	2.3 V
56	—	VCCLSP: L-ch. speaker amplifier power supply pin	5 V

■ Application Notes

1. Pin descriptions

- Pin 1 (power supply for R-ch. speaker power use)
Please put a capacitor of about 100 μ F between pin 1 and pin 5.
- Pin 2, pin 3 (R-ch. speaker output) (BTL out)
- Pin 4 (N.C.)
- Pin 5 (GND for R-ch. speaker power use)
- Pin 6, pin 45, pin 46, pin 47, pin 48, pin 49 (bass boost)
Following equivalent circuit is for bass boost.

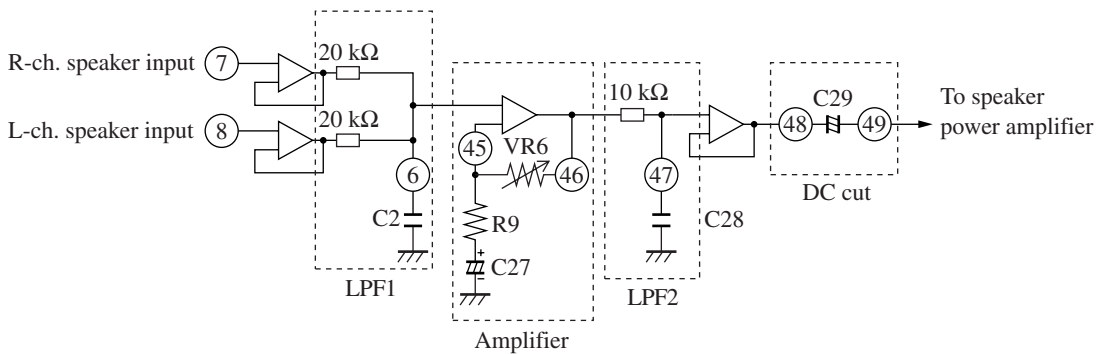

■ Application Notes (continued)

1. Pin descriptions (continued)

- Pin 6, pin 45, pin 46, pin 47, pin 48, pin 49 (bass boost) (continued)
 - 1) Pin 6

This pin makes first LPF together with internal registers.
When a value of C2 is 0.1 μ F, cutoff frequency is 160 Hz.
 - 2) Pin 45, pin 46

This gain is
$$G_v = \frac{VR6 + R9}{R9}$$
 It is necessary that VR6 = 10 k Ω , R9 = 10 k Ω for amplifier gain of two times. However this bass boost signal is mixed with the basis signal by speaker power amplifier on reverse phase, then if suitable value of VR6 is 75 k Ω . The HPF is composed with R9 and C27, then if R9 is 10 k Ω , suitable value of C27 is 1 μ F.
 - 3) Pin 47

This pin makes second LPF together with internal registers.
When a value of C28 is 0.1 μ F, peak gain frequency is 160 Hz.
 - 4) Pin 48, pin 49

This purpose is DC cut. Suitable value of C29 is 4.7 μ F (nonpolar), because input impedance of speaker power amplifier is 2 k Ω .
- Pin 7, pin 8 (L-ch., R-ch. speaker input)

Suitable value of C3, C4 is 3.3 μ F, because input impedance of speaker power amplifier is 2 k Ω .
Supposing that max output level of headphone is 1 V[rms], suitable value of R1, R2 is 25 k Ω , because gain of speaker power amplifier is 32 dB.
- Pin 9 (ripple filter of speaker amplifier)

Recommended value is 22 μ F.
If capacitor value is bigger, rise time at standby is longer.
If capacitor value is smaller, rise time at stanby is shorter, but there are possibilities of pop sound occurrence and deterioration of power supply ripple rejection, cross talk and THD.
- Pin 10 (power supply (speaker small signal use))

Please put a capacitor of 33 μ F between GND (pin 38) and pin 10.
- Pin 50 (bass boost limit control)

Please put an about 10 k Ω register between pin 51 and GND.
- Pin 51 (bass boost on/off switch)

Suitable value of R11 is 50 k Ω and suitable value of C30 is 1 μ F.
Rise time is about 20 ms.
If value of R and C is smaller, switching time is shorter but there is a possibility of pop sound occurrence.
- Pin 56 (power supply (L-ch. speaker power use))

Please put an about 100 μ F capacitor between pin 56 and pin 52.
- Pin 55, pin 54 (L-ch. speaker output) (BTL out)
- Pin 53 (N.C.)
- Pin 52 (GND (L-ch. speaker power use))
- Pin 44 (standby (speaker))

Suitable value of R10 is 50 k Ω or more.
Swichting time depends on value of pin 9 capacitor.
If value of C5 is 22 μ F, rise time is about 80 ms.
- Pin 43 (speaker mute control)

Suitable value of R8 is 50 k Ω , suitable value of C26 is 1 μ F.
Rise time is about 20 ms.
If value of R and C is smaller, switching time is shorter, but there is a possibility of pop sound occurrence.
- Pin 38 (GND (speaker small signal use))

■ Application Notes (continued)

1. Pin descriptions (continued)

- Pin 11, pin 12 (L-ch., R-ch. headphone output)
In consideration of headphone load, suitable value of C7, C8 is 220 μ F.
- Pin 13 (GND (headphone power use))
- Pin 14 (GND (headphone small signal use))
- Pin 15 (N.C.)
Pin 15 connects to IC's heat sink.
- Pin 16 (power supply (headphone power use))
Please put an about 100 μ F capacitor between pin 13 and pin 14.
- Pin 17 (power supply (headphone small signal use))
Please put an about 33 μ F capacitor between pin 13 and pin 14.
- Pin 18, pin 19, pin 20, pin 21
Please open.
- Pin 22 (beep input)
Suitable value of R4 is 33 k Ω and suitable value of C14 is 1 μ F.
- Pin 23
Please open.
- Pin 24 (R-ch. headphone spatializer off mode input)
Suitable value of C15 is 1 μ F, because input impedance of headphone power amplifier is 20 k Ω .
- Pin 25 (L-ch. headphone spatializer off mode input)
Suitable value of C16 is 1 μ F, because input impedance of headphone power amplifier is 20 k Ω .
- Pin 26
Please open.
- Pin 27 (line amplifier L-ch. input)
Suitable value of C17 is 1 μ F, because input impedance of line amplifier is 50 k Ω .
- Pin 28 (line amplifier R-ch. input)
Suitable value of C18 is 1 μ F, because input impedance of line amplifier is 50 k Ω .
- Pin 29 (line amplifier R-ch. output)
Suitable value of C19 is 1 μ F.
- Pin 30 (GND (line amplifier))
- Pin 31 (line amplifier L-ch. output)
Suitable value of C20 is 1 μ F.
- Pin 32 (beep control (line amplifier))
A value of VR2 is bigger, output level is smaller.
- Pin 33 (line amplifier mute control)
Suitable value of R5 is 50 k Ω and suitable value of C21 is 1 μ F.
Rise time is about 20 ms.
If value of R and C is smaller, switching time is shorter but there is a possibility of pop sound occurrence.
- Pin 34 (beep control (headphone amplifier))
A value of VR3 is bigger, output level is smaller.
- Pin 35 (headphone amplifier mute control)
Suitable value of R6 is 50 k Ω and suitable value of C22 is 1 μ F.
Rise time is about 20 ms.
If value of R and C is smaller, switching time is shorter but there is a possibility of pop sound occurrence.
- Pin 36
Please connect to GND.

■ Application Notes (continued)

1. Pin descriptions (continued)

- Pin 37 (ripple filter (headphone))
A recommended value is 47 μ F.
If capacitor value is bigger, rise time at standby is longer.
If capacitor value is smaller, rise time at standby is shorter, but there are possibilities of pop sound occurrence and deteriorations of power supply ripple rejection and cross talk and THD.
- Pin 39 (volume control)
Please put a variable volume of 50 k Ω or more between headphone V_{CC} and headphone GND.
- Pin 40 (ripple filter (line amplifier))
A recommended value is 47 μ F.
If capacitor value is bigger, rise time at standby is longer.
If capacitor value is smaller, rise time at standby is shorter, but there are possibilities of pop sound occurrence and deteriorations of power supply ripple rejection and cross talk and THD.
- Pin 41 (standby (line amplifier, headphone amplifier))
Switching time depends on value of pin 37 and pin 40 capacitors.
- Pin 42 (N.C.)
Pin 42 connects to IC's heat sink (fin).
 - 1) Case of not using bass boost
Please open pin 6, pin 45, pin 46, pin 47, pin 48, pin 49 and pin 50.
Please connect pin 51 to GND.
 - 2) Case of not using line amplifier
Please open pin 27, pin 28, pin 29, pin 31 and pin 32.
Please connect pin 33 to GND.

■ Application Notes (continued)

2. Printed circuit board layout example for evaluation board

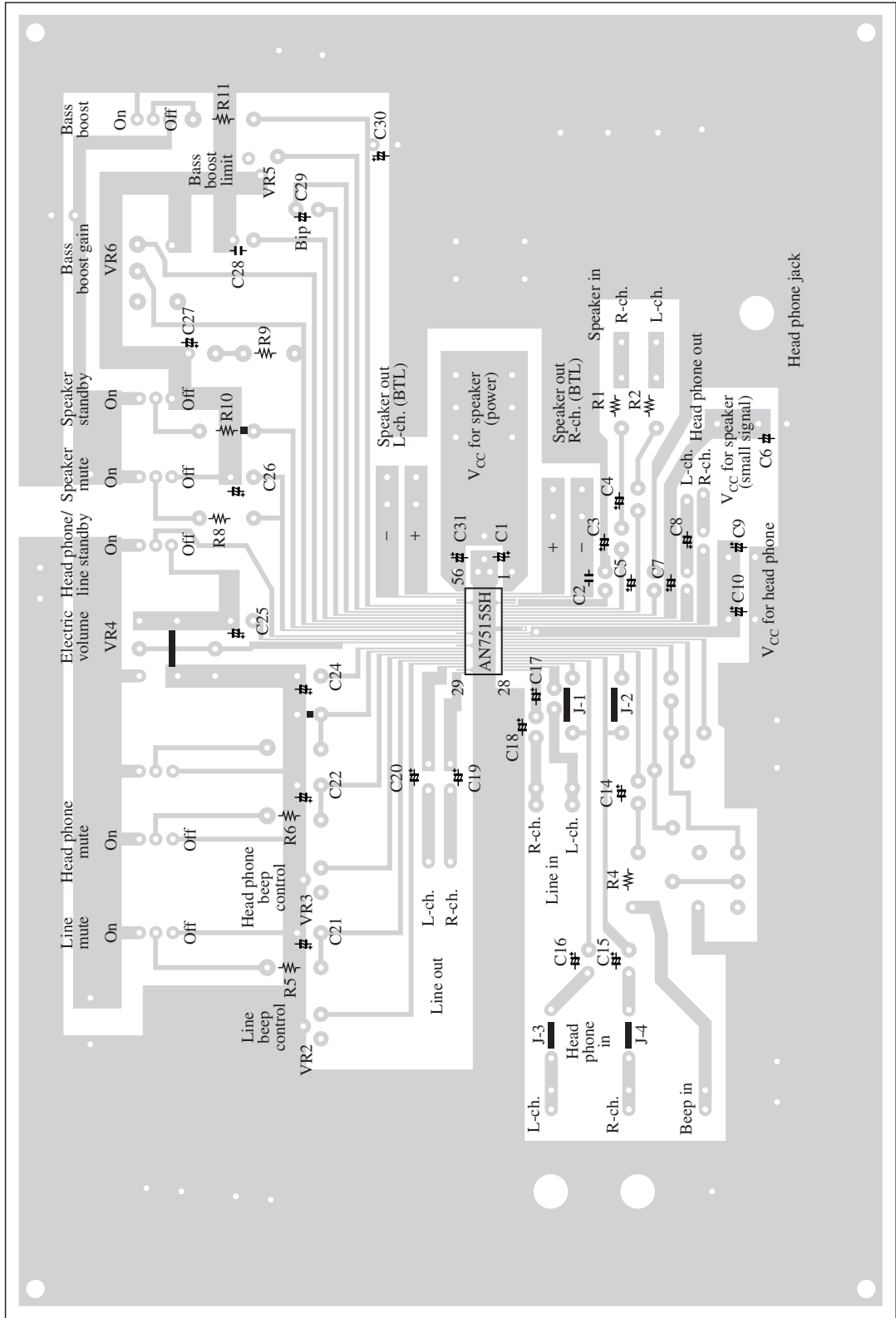

■ Technical Data

1. $P_D - T_a$ curves of HSOP056-P-0300A

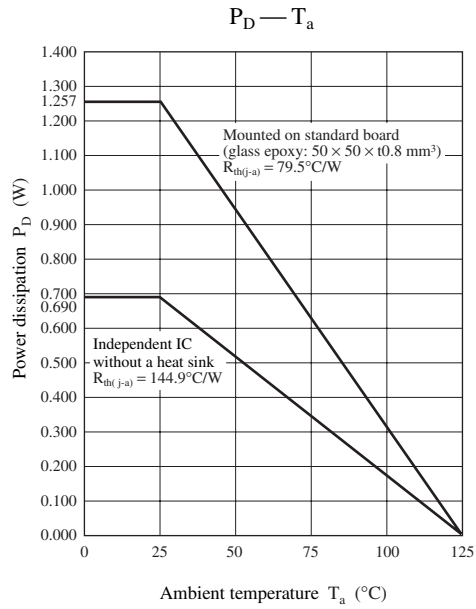

■ Technical Data (continued)

2. Main characteristics

1) SP amplifier

(1) Output power

L-ch. 8 Ω

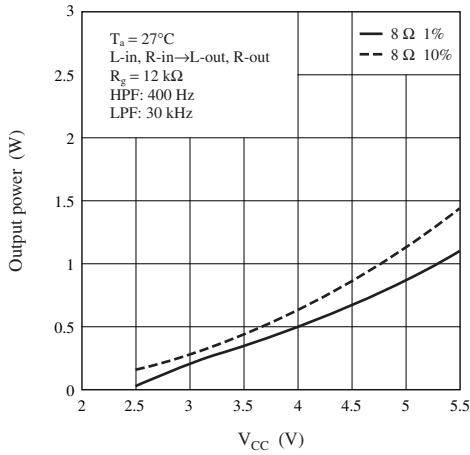

L-ch. 4 Ω

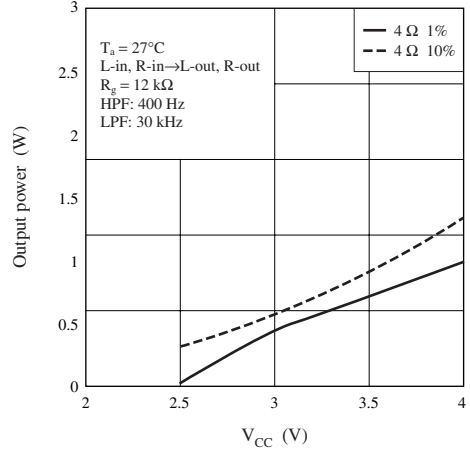

R-ch. 8 Ω

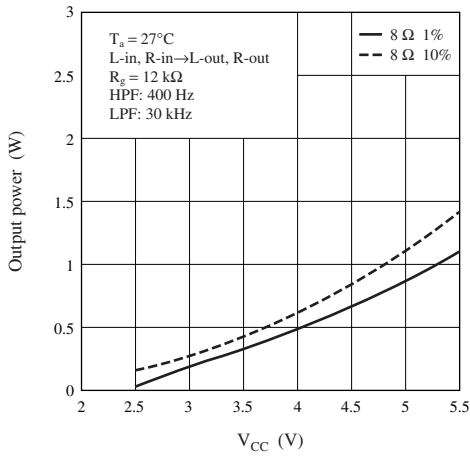

R-ch. 4 Ω

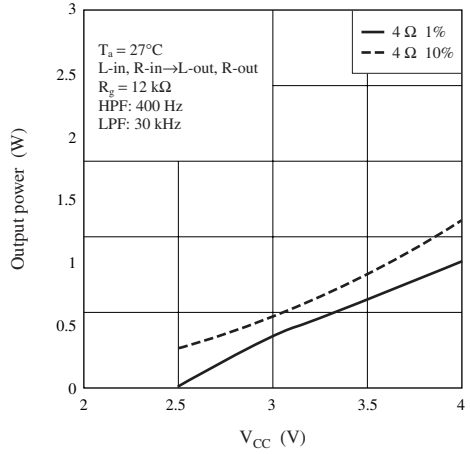

■ Technical Data (continued)

2. Main characteristics (continued)

1) SP amplifier (continued)

(2) $V_{CC} = 5\text{ V}$, $T_a = 27^\circ\text{C}$

Gain — Frequency

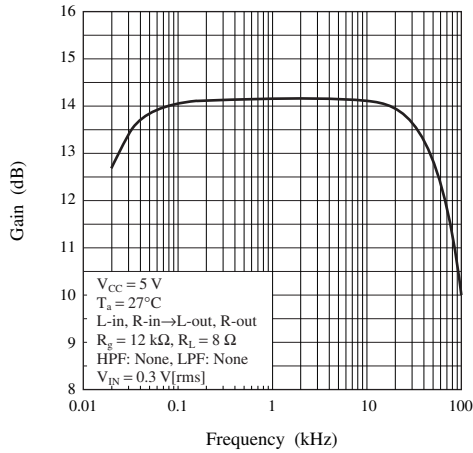

Output level — Input level

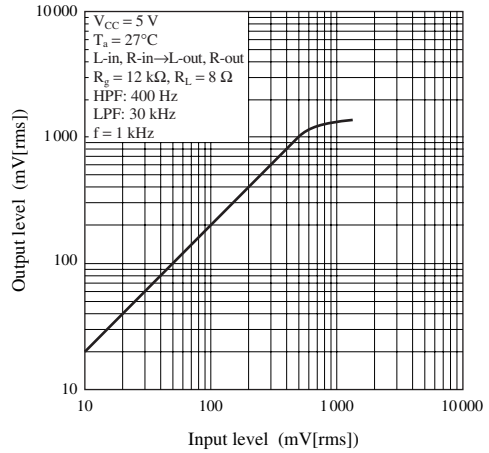

THD — Frequency

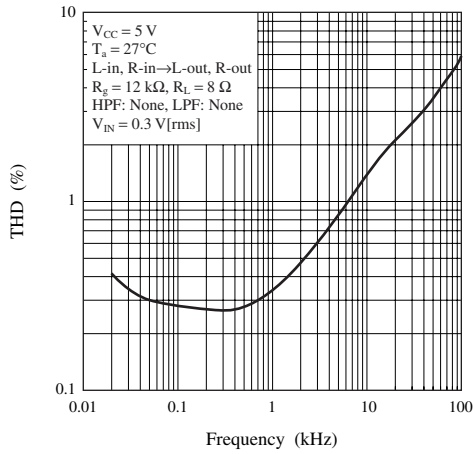

THD — Input level

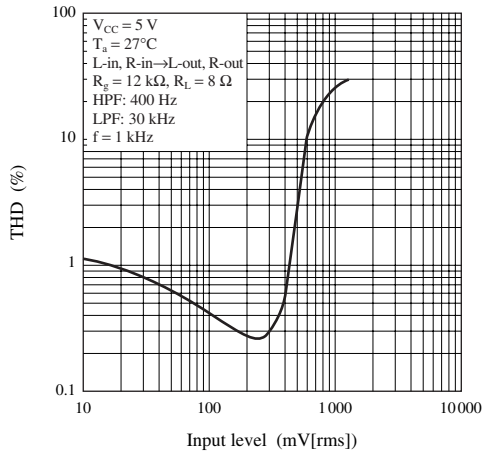

■ Technical Data (continued)

2. Main characteristics (continued)

2) HP amplifier

(1) $V_{CC} = 5\text{ V}$, $T_a = 27^\circ\text{C}$

Gain — Frequency

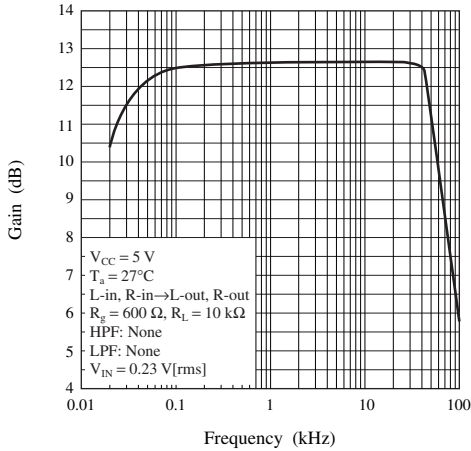

Output level — Input level

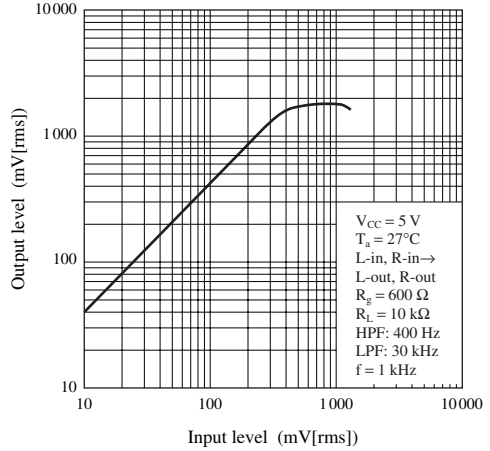

THD — Frequency

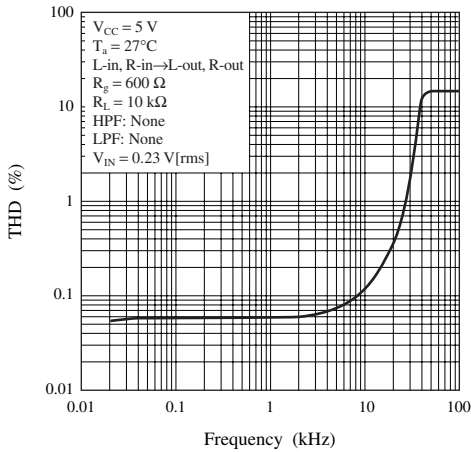

THD — Input level

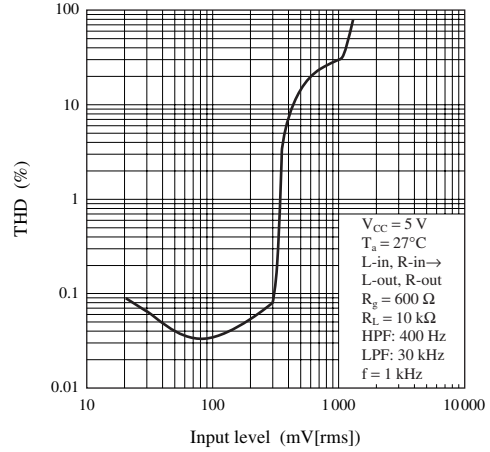

■ Technical Data (continued)

2. Main characteristics (continued)

3) Line amplifier

(1) $V_{CC} = 5\text{ V}$, $T_a = 27^\circ\text{C}$

Gain — Frequency

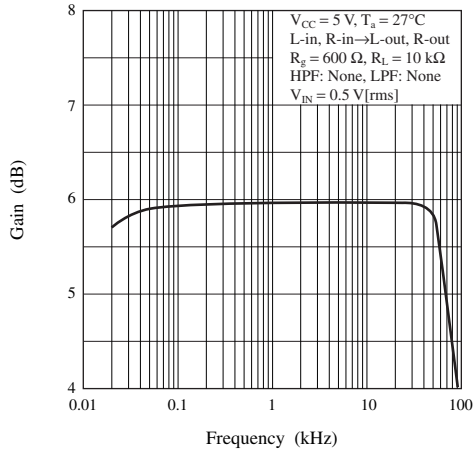

Output level — Input level

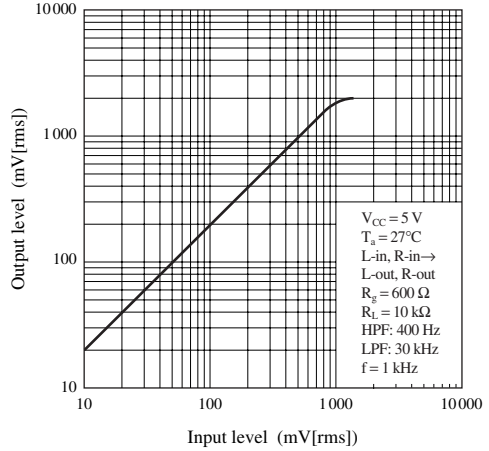

THD — Frequency

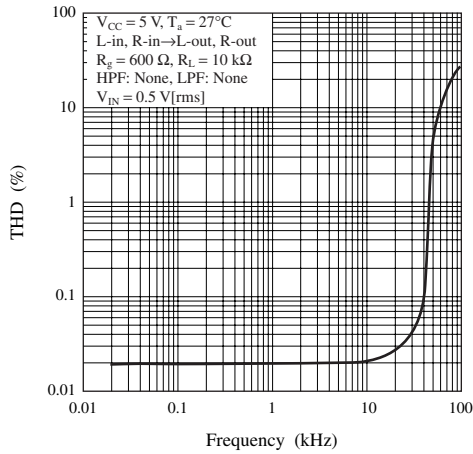

THD — Input level

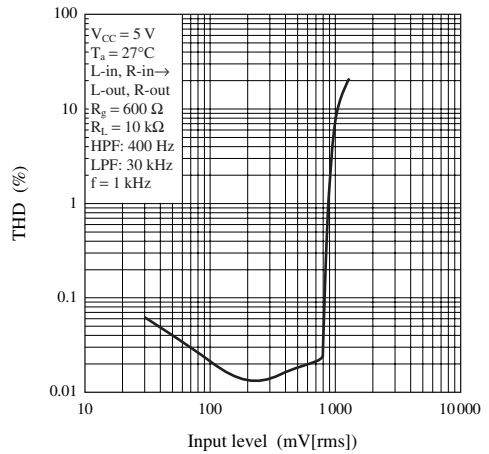

■ Technical Data (continued)

2. Main characteristics (continued)

4) Volume

(1) $V_{CC} = 3.3\text{ V}$, $T_a = 27^\circ\text{C}$

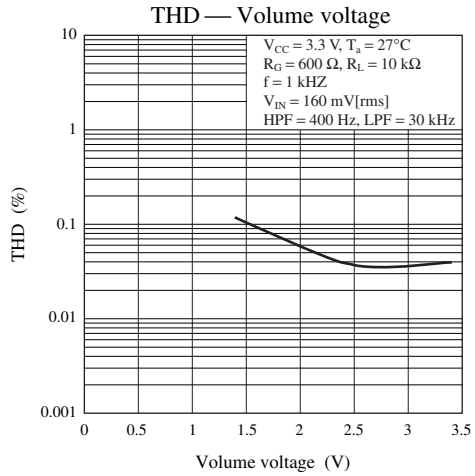
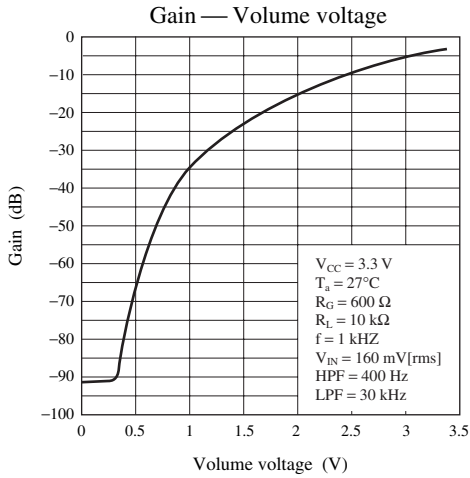

(2) $V_{CC} = 5\text{ V}$, $T_a = 27^\circ\text{C}$

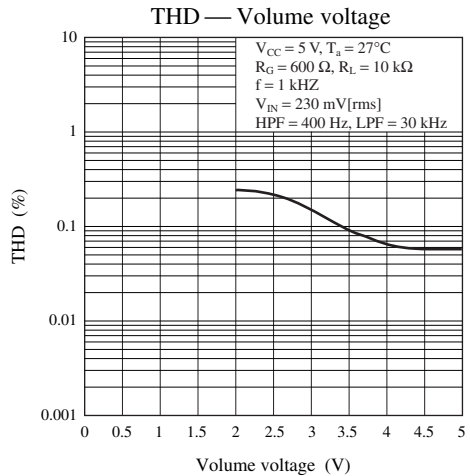
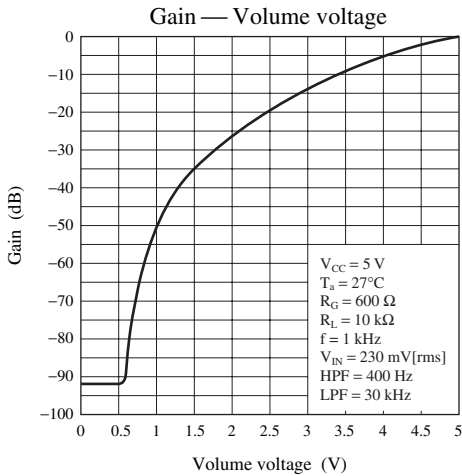

5) Bass boost

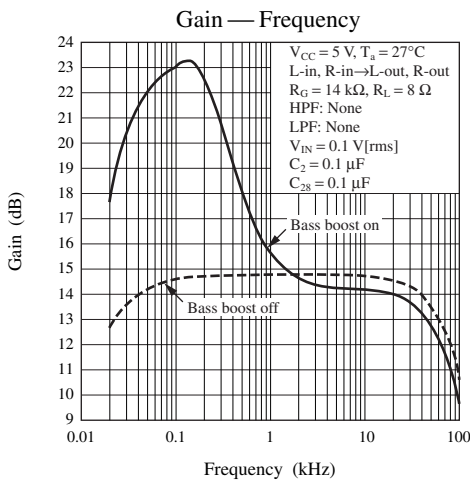

■ Usage Notes

1.
 - 1) Make sure that the IC is free of output- V_{CC} short, output-GND short and load short.
 - 2) The thermal protection circuit operates at a T_j of approximately 150°C. The thermal protection circuit is reset automatically when the temperature drops.
 - 3) Beep in pin should not be down more than -0.3 V.
 - 4) The IC should not be inserted in reverse.
2. The IC has the possibility of break-down as follows.
 - 1) Reverse connection of the V_{CC} and GND.
 - 2) The power supply connection to output-pins (pin 55, pin 54, pin 2 and pin 3), when V_{CC} and GND are opened.
 - 3) Output-GND short, when GND pin is opened.
 - 4) Output pins (pin 55, pin 54, pin 2 and pin 3) short to GND.
 - 5) Output pins (pin 55, pin 54, pin 2 and pin 3) short to V_{CC} .
 - 6) Short between outputs.
 - 7) Reverse insertion.

Request for your special attention and precautions in using the technical information and semiconductors described in this material

- (1) An export permit needs to be obtained from the competent authorities of the Japanese Government if any of the products or technologies described in this material and controlled under the "Foreign Exchange and Foreign Trade Law" is to be exported or taken out of Japan.
- (2) The technical information described in this material is limited to showing representative characteristics and applied circuit examples of the products. It does not constitute the warranting of industrial property, the granting of relative rights, or the granting of any license.
- (3) The products described in this material are intended to be used for standard applications or general electronic equipment (such as office equipment, communications equipment, measuring instruments and household appliances).
Consult our sales staff in advance for information on the following applications:
 - Special applications (such as for airplanes, aerospace, automobiles, traffic control equipment, combustion equipment, life support systems and safety devices) in which exceptional quality and reliability are required, or if the failure or malfunction of the products may directly jeopardize life or harm the human body.
 - Any applications other than the standard applications intended.
- (4) The products and product specifications described in this material are subject to change without notice for reasons of modification and/or improvement. At the final stage of your design, purchasing, or use of the products, therefore, ask for the most up-to-date Product Standards in advance to make sure that the latest specifications satisfy your requirements.
- (5) When designing your equipment, comply with the guaranteed values, in particular those of maximum rating, the range of operating power supply voltage and heat radiation characteristics. Otherwise, we will not be liable for any defect which may arise later in your equipment.
Even when the products are used within the guaranteed values, redundant design is recommended, so that such equipment may not violate relevant laws or regulations because of the function of our products.
- (6) When using products for which dry packing is required, observe the conditions (including shelf life and after-unpacking standby time) agreed upon when specification sheets are individually exchanged.
- (7) No part of this material may be reprinted or reproduced by any means without written permission from our company.

Please read the following notes before using the datasheets

- A. These materials are intended as a reference to assist customers with the selection of Panasonic semiconductor products best suited to their applications.
Due to modification or other reasons, any information contained in this material, such as available product types, technical data, and so on, is subject to change without notice.
Customers are advised to contact our semiconductor sales office and obtain the latest information before starting precise technical research and/or purchasing activities.
- B. Panasonic is endeavoring to continually improve the quality and reliability of these materials but there is always the possibility that further rectifications will be required in the future. Therefore, Panasonic will not assume any liability for any damages arising from any errors etc. that may appear in this material.
- C. These materials are solely intended for a customer's individual use.
Therefore, without the prior written approval of Panasonic, any other use such as reproducing, selling, or distributing this material to a third party, via the Internet or in any other way, is prohibited.

This datasheet has been download from:

www.datasheetcatalog.com

Datasheets for electronics components.