

PT380/PT380F PT381/PT381F

High Sensitivity, ϕ 3mm Resin Mold Type
Phototransistor

■ Features

- High sensitivity
(I_C : MIN.160 μ A at $E_V = 100lx$, **PT380**)
(I_C : MIN.120 μ A at $E_V = 2lx$, **PT381**)
- Compact ϕ 3mm resin mold package
- Intermediate acceptance ($\Delta\theta$: TYP. $\pm 20^\circ$)
- Visible light cut-off type : **PT380F/PT381F**

■ Model Line-ups

	Single photo-transistor output	Darlington photo-transistor output
No visible light cut-off filter	PT380	PT381
Built-in visible light cut-off filter	PT380F	PT381F

■ Applications

- Floppy disk drives
- Optoelectronic switches
- Infrared applied systems

■ Outline Dimensions

(Unit : mm)

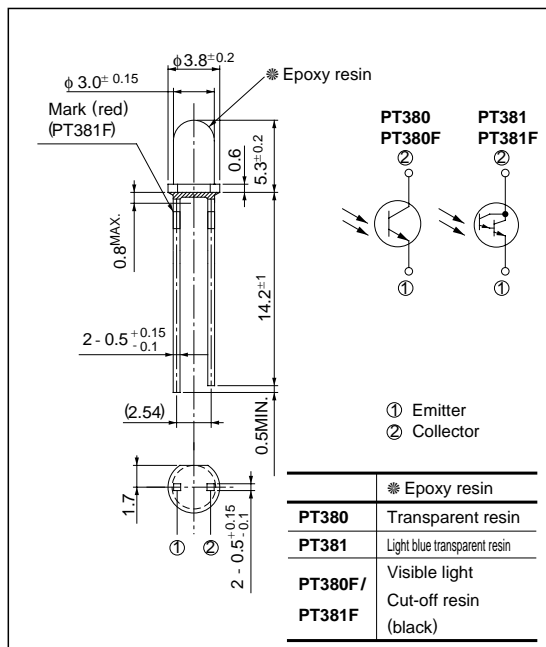

■ Absolute Maximum Ratings

($T_a = 25^\circ C$)

Parameter	Symbol	Rating	Unit
Collector-emitter voltage	V_{CEO}	35	V
Emitter-collector voltage	V_{ECO}	6	V
Collector current	I_C	20	mA
Collector power dissipation	P_C	50	mW
Operating temperature	T_{opr}	- 25 to + 85	$^\circ C$
Storage temperature	T_{stg}	- 40 to + 85	$^\circ C$
*1 Soldering temperature	T_{sol}	260	$^\circ C$

*1 For 3 seconds at the position of 1.4mm from the bottom face of resin package

■ Electro-optical Characteristics

($T_a = 25^\circ\text{C}$)

Parameter		Symbol	Conditions	MIN.	TYP.	MAX.	Unit
² Collector current	PT380	I_C	$E_v = 100l_x$	0.16	-	1.17	mA
	PT380F		$V_{CE} = 5V$	0.095	-	0.90	
	PT381		$E_v = 2l_x$	0.12	-	1.5	
	PT381F		$V_{CE} = 10V$	0.07	-	1.08	
Collector dark current	PT380/PT380F	I_{CEO}	$E_e = 0, V_{CE} = 20V$	-	-	0.1	μA
	PT381/PT381F		$E_e = 0, V_{CE} = 10V$	-	-	1.0	
² Collector-emitter saturation voltage	PT380/PT380F	$V_{CE(sat)}$	$E_e = 10\text{mW/cm}^2, I_C = 0.5\text{mA}$	-	0.2	0.4	V
	PT381/PT381F		$E_e = 1\text{mW/cm}^2, I_C = 2.5\text{mA}$	-	-	1.0	
Collector-emitter breakdown voltage		BV_{CEO}	$I_C = 0.1\text{mA}$ $E_e = 0$	35	-	-	V
Emitter-Collector breakdown voltage		BV_{ECO}	$I_C = 0.01\text{mA}$ $E_e = 0$	6	-	-	V
Peak sensitivity wavelength	PT380/PT381	λ_P	-	-	800	-	nm
	PT380F/PT381F			-	860	-	
Response time	Rise time	t_r	$V_{CE} = 20V, I_C = 1\text{mA}, R_L = 1\text{k}\Omega$	-	10	40	μs
			$V_{CE} = 2V, I_C = 10\text{mA}, R_L = 100\Omega$	-	100	400	
	Fall time	t_f	$V_{CE} = 20V, I_C = 1\text{mA}, R_L = 1\text{k}\Omega$	-	8	35	
			$V_{CE} = 2V, I_C = 10\text{mA}, R_L = 100\Omega$	-	100	400	
Half intensity angle		$\Delta\theta$	-	-	± 20	-	$^\circ$

*2 E_v, E_e : Illuminance, irradiance by CIE standard light source A (tungsten lamp)

Fig. 1 Collector Power Dissipation vs. Ambient Temperature

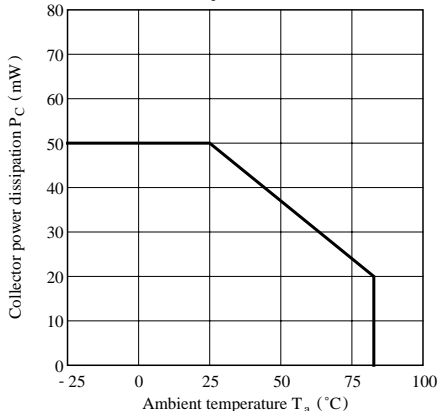

Fig. 2-a Collector Dark Current vs. Ambient Temperature (PT380/PT380F)

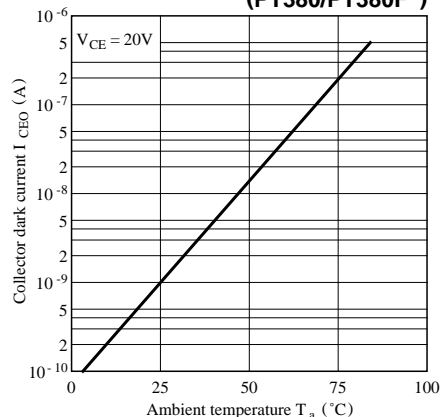

Fig. 2-b Collector Dark Current vs. Ambient Temperature (PT381/381F)

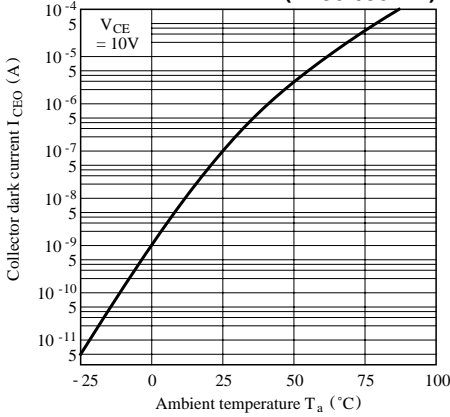

Fig. 3-a Relative Collector Current vs. Ambient Temperature (PT380/PT380F)

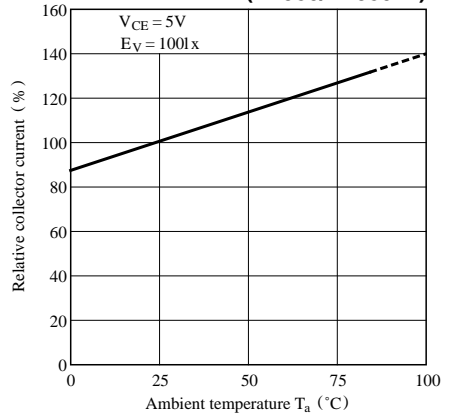

Fig. 3-b Relative Collector Current vs. Ambient Temperature (PT381/PT381F)

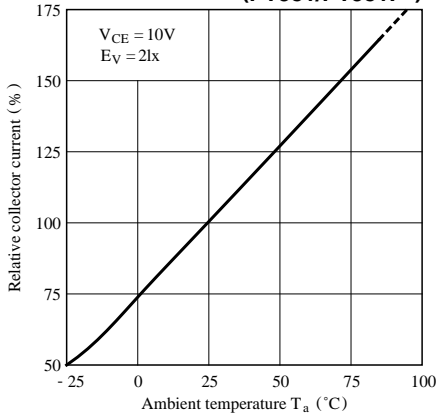

Fig. 4-a Collector Current vs. Irradiance (PT380/380F)

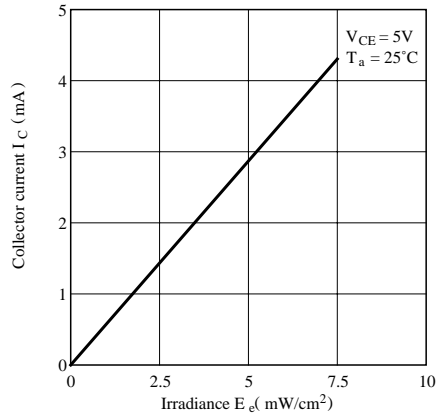

Fig. 4-b Collector Current vs. Irradiance (PT381/PT381F)

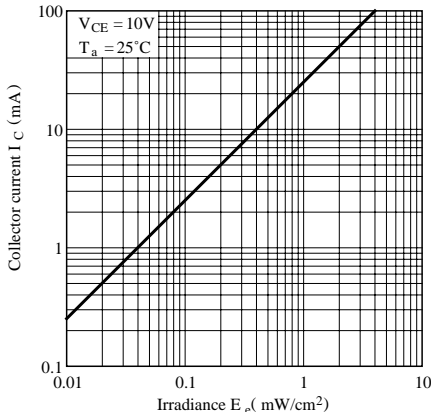

Fig. 5-a Collector Current vs. Collector-emitter Voltage (PT380/380F)

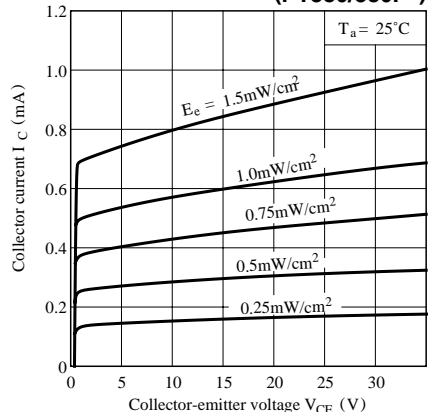

Fig. 5-b Collector Current vs. Collector-emitter Voltage (PT381/381F)

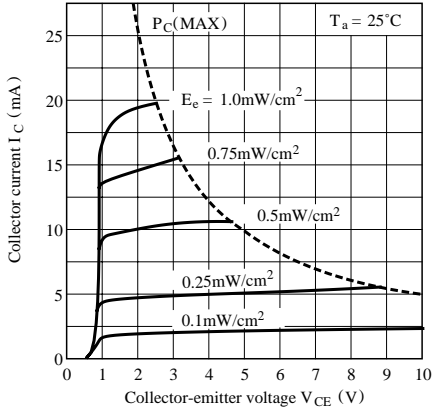

Fig. 6 Spectral Sensitivity

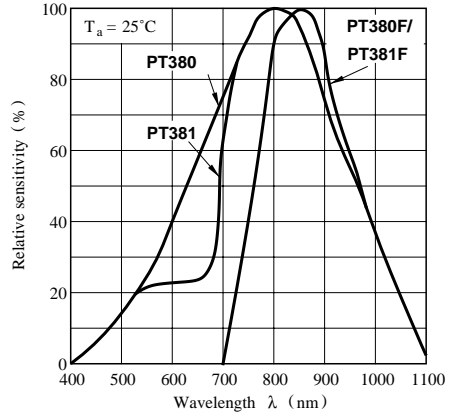
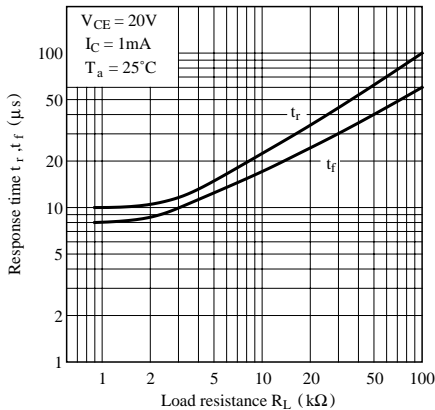

Fig. 7-a Response Time vs. Load Resistance (PT380/PT380F)



Test Circuit for Response Time

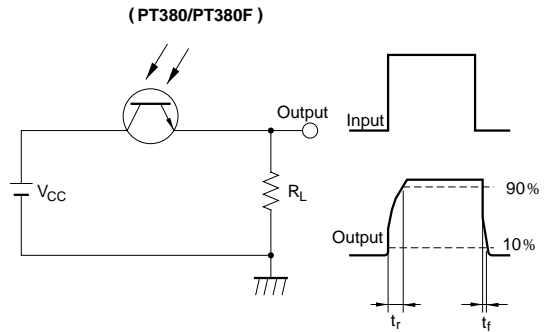
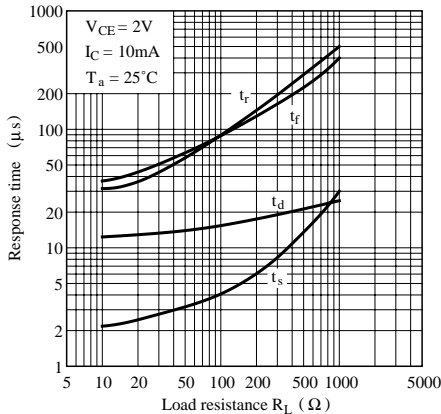

Fig. 7-b Response Time vs. Load Resistance (PT381/381F)



Test Circuit for Response Time

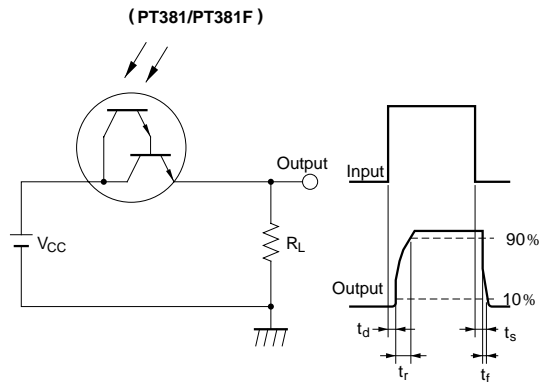

Fig. 8-a Collector-emitter Saturation Voltage vs. Irradiance (PT380/380F)

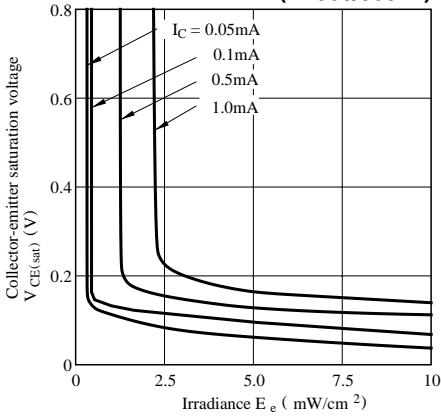

Fig. 8-b Collector-emitter Saturation Voltage vs. Irradiance (PT381/381F)

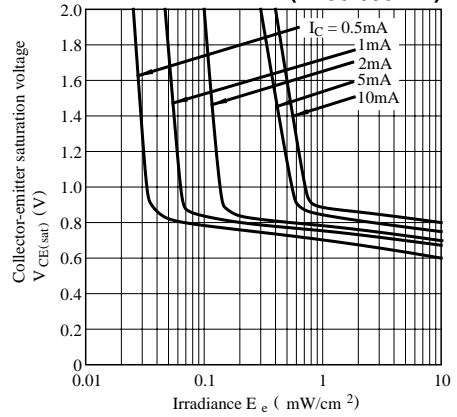

Fig. 9 Sensitivity Diagram (T_a = 25°C)

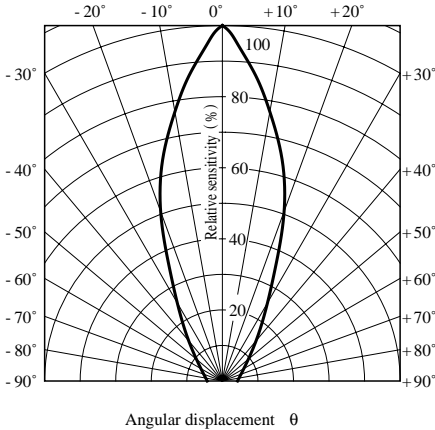
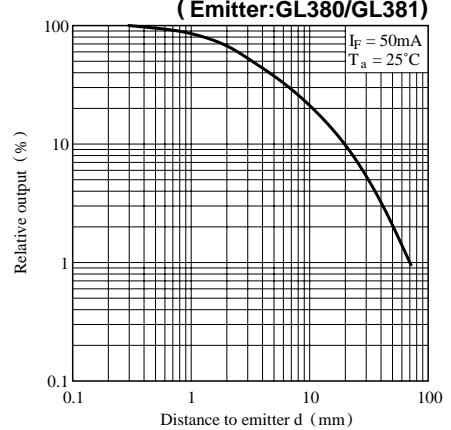

Fig.10 Relative Collector Current vs. Distance to Emitter (Emitter:GL380/GL381)



Please refer to the chapter “Precautions for Use.”