

## P-Channel Enhancement-Mode MOSFET Transistor

### Product Summary

$V_{(BR)DSS}$ Min (V)	$r_{DS(on)}$ Max ( $\Omega$ )	$V_{GS(th)}$ (V)	$I_D$ (A)
-60	5 @ $V_{GS} = -10$ V	-2 to -4.5	-0.41

### Features

- High-Side Switching
- Low On-Resistance: 2.5  $\Omega$
- Moderate Threshold: -3.4 V
- Fast Switching Speed: 40 ns
- Low Input Capacitance: 75 pF

### Benefits

- Ease in Driving Switches
- Low Offset (Error) Voltage
- Low-Voltage Operation
- High-Speed Switching
- Easily Driven Without Buffer0

### Applications

- Drivers: Relays, Solenoids, Lamps, Hammers, Displays, Memories, Transistors, etc.
- Battery Operated Systems
- Power Supply, Converter Circuits
- Motor Control

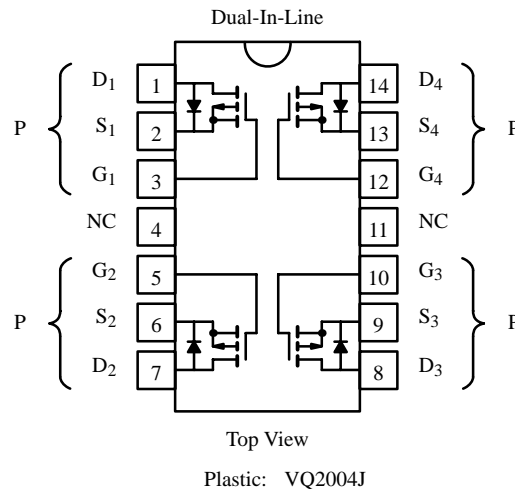

### Absolute Maximum Ratings ( $T_A = 25^\circ\text{C}$ Unless Otherwise Noted)

Parameter	Symbol	Single	Total Quad	Unit
Drain-Source Voltage	$V_{DS}$	-60		V
Gate-Source Voltage	$V_{GS}$	$\pm 30$		
Continuous Drain Current ( $T_J = 150^\circ\text{C}$ )	$I_D$	$T_A = 25^\circ\text{C}$	-0.41	A
		$T_A = 100^\circ\text{C}$	-0.23	
Pulsed Drain Current <sup>a</sup>	$I_{DM}$	-3		
Power Dissipation	$P_D$	$T_A = 25^\circ\text{C}$	1.3	2
		$T_A = 100^\circ\text{C}$	0.52	0.8
Maximum Junction-to-Ambient	$R_{thJA}$	96	62.5	$^\circ\text{C}/\text{W}$
Operating Junction and Storage Temperature Range	$T_J, T_{stg}$	-55 to 150		$^\circ\text{C}$

Notes

a. Pulse width limited by maximum junction temperature.

Updates to this data sheet may be obtained via facsimile by calling Siliconix FaxBack, 1-408-970-5600. Please request FaxBack document #70220.

# VQ2004J

## Specifications<sup>a</sup>

Parameter	Symbol	Test Conditions	Limits			Unit
			Min	Typ <sup>b</sup>	Max	
<b>Static</b>						
Drain-Source Breakdown Voltage	$V_{(BR)DSS}$	$V_{GS} = 0 \text{ V}, I_D = -10 \mu\text{A}$	-60	-110		V
Gate-Threshold Voltage	$V_{GS(th)}$	$V_{DS} = V_{GS}, I_D = -1 \text{ mA}$	-2	-3.4	-4.5	
Gate-Body Leakage	$I_{GSS}$	$V_{DS} = 0 \text{ V}, V_{GS} = \pm 30 \text{ V}$ $T_J = 125^\circ\text{C}$			$\pm 100$	nA
					$\pm 500$	
Zero Gate Voltage Drain Current	$I_{DSS}$	$V_{DS} = -60 \text{ V}, V_{GS} = 0 \text{ V}$			-10	$\mu\text{A}$
		$V_{DS} = -48 \text{ V}, V_{GS} = 0 \text{ V}, T_J = 125^\circ\text{C}$			-500	
On-State Drain Current <sup>c</sup>	$I_{D(on)}$	$V_{DS} = -10 \text{ V}, V_{GS} = -10 \text{ V}$	-1	-2		A
Drain-Source On-Resistance <sup>c</sup>	$r_{DS(on)}$	$V_{GS} = -10 \text{ V}, I_D = -1 \text{ A}$ $T_J = 125^\circ\text{C}$		2.5	5	$\Omega$
				4.4	8	
Forward Transconductance <sup>c</sup>	$g_{fs}$	$V_{DS} = -10 \text{ V}, I_D = -0.5 \text{ A}$	200	325		mS
Common Source Output Conductance <sup>c</sup>	$g_{os}$	$V_{DS} = -7.5 \text{ V}, I_D = -0.1 \text{ A}$		0.45		
<b>Dynamic</b>						
Input Capacitance	$C_{iss}$	$V_{DS} = -25 \text{ V}, V_{GS} = 0 \text{ V}$ $f = 1 \text{ MHz}$		75	150	pF
Output Capacitance	$C_{oss}$			40	60	
Reverse Transfer Capacitance	$C_{rss}$			18	25	
<b>Switching<sup>d</sup></b>						
Turn-On Time	$t_{d(on)}$	$V_{DD} = -25 \text{ V}, R_L = 47 \Omega$ $I_D \cong -0.5 \text{ A}, V_{GEN} = -10 \text{ V}$ $R_G = 25 \Omega$		11	15	ns
	$t_r$			30	40	
Turn-Off Time	$t_{d(off)}$			20	30	
	$t_f$			20	30	

### Notes

- $T_A = 25^\circ\text{C}$  unless otherwise noted.
- For DESIGN AID ONLY, not subject to production testing.
- Pulse test:  $PW \leq 300 \mu\text{s}$  duty cycle  $\leq 2\%$ .
- Switching time is essentially independent of operating temperature.

VPDV10

## Typical Characteristics (25°C Unless Otherwise Noted)

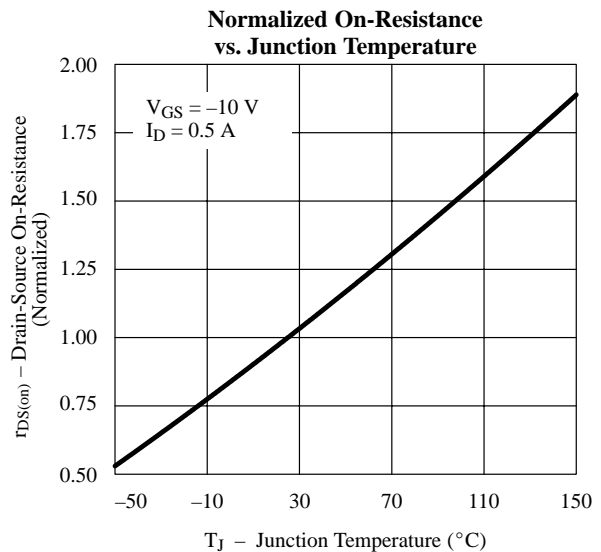
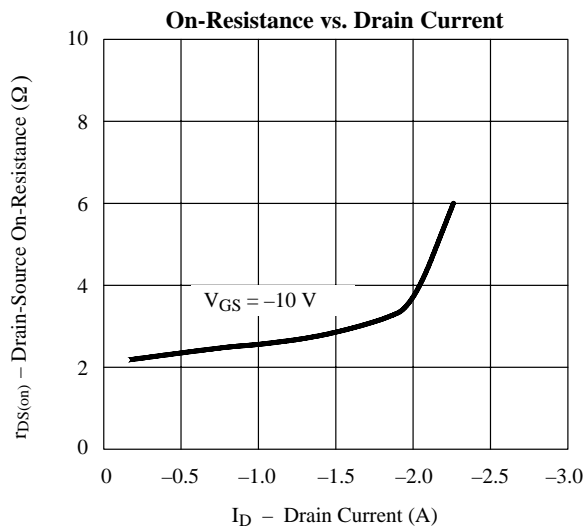
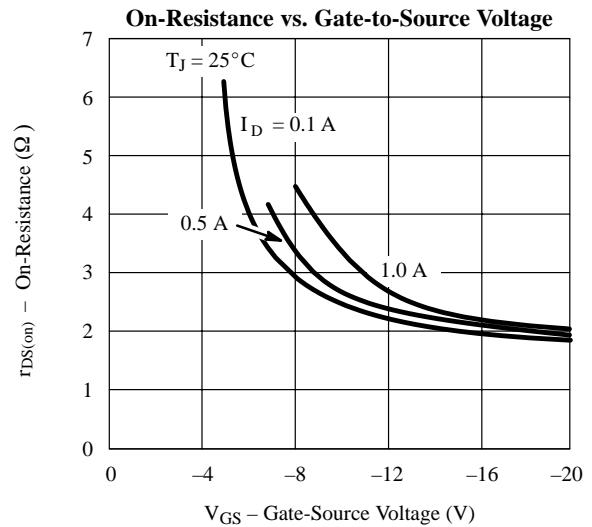
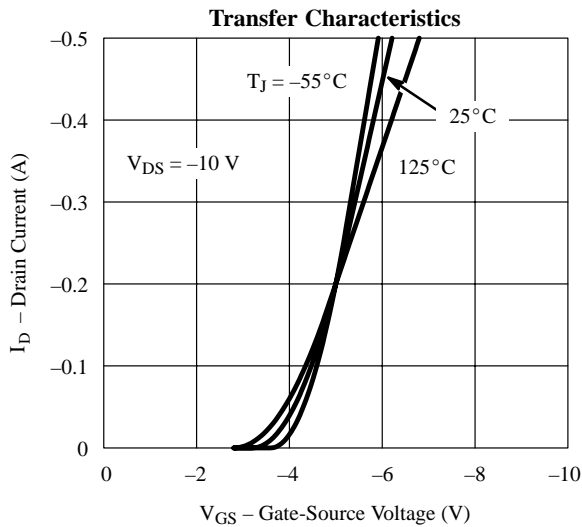
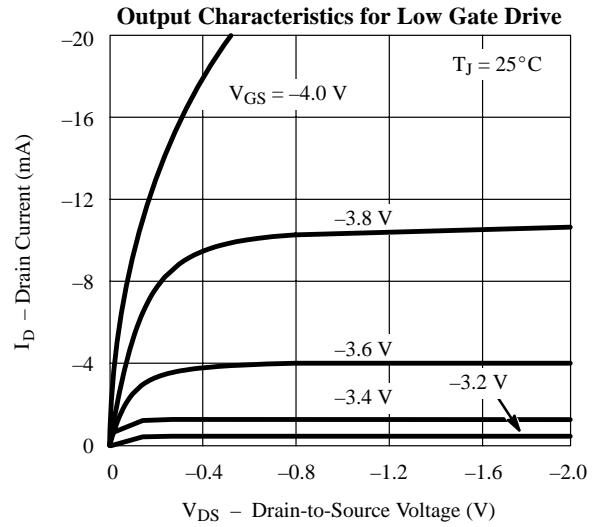
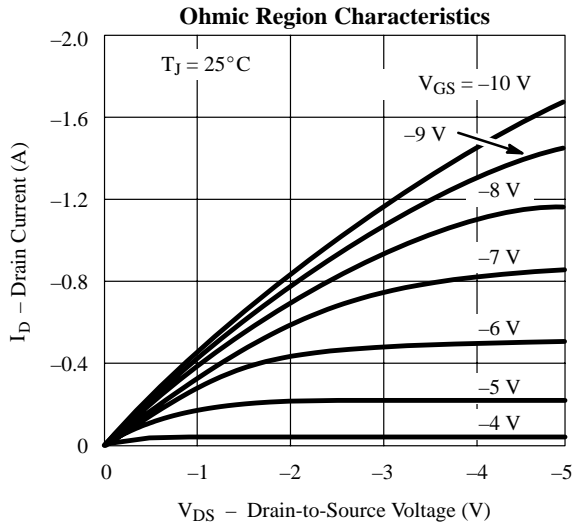

# VQ2004J

## Typical Characteristics (25°C Unless Otherwise Noted) (Cont'd)

