



# BTA10 and BTB10 Series

SNUBBERLESSTM & STANDARD

10A TRIACs

**Table 1: Main Features**

Symbol	Value	Unit
$I_{T(RMS)}$	10	A
$V_{DRM}/V_{RRM}$	600 and 800	V
$I_{GT}(Q_1)$	25 to 50	mA

## DESCRIPTION

Available either in through-hole or surface-mount packages, the **BTA10** and **BTB10** triac series is suitable for general purpose AC switching. They can be used as an ON/OFF function in applications such as static relays, heating regulation, induction motor starting circuits... or for phase control operation in light dimmers, motor speed controllers,...

The snubberless version (W suffix) is specially recommended for use on inductive loads, thanks to their high commutation performances.

By using an internal ceramic pad, the BTA series provides voltage insulated tab (rated at 2500V<sub>RMS</sub>) complying with UL standards (File ref.: E81734).

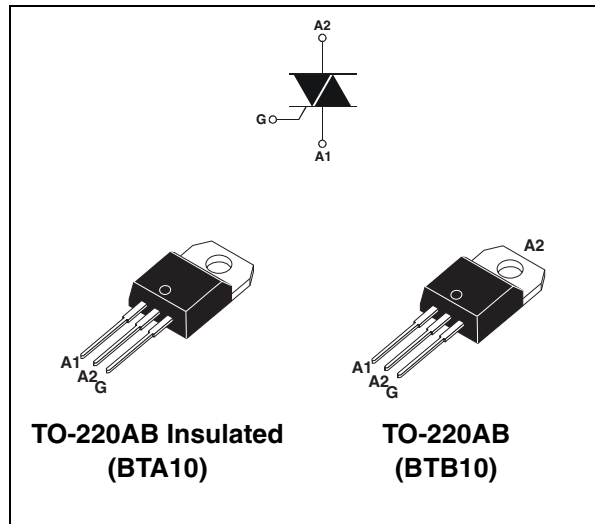

**Table 2: Order Codes**

Part Number	Marking
BTA10-xxxxxRG	See page table 8 on page 6
BTB10-xxxxxRG	

**Table 3: Absolute Maximum Ratings**

Symbol	Parameter	Value	Unit	
$I_{T(RMS)}$	RMS on-state current (full sine wave)	TO-220AB $T_c = 105^\circ\text{C}$	10	A
		TO-220AB Ins. $T_c = 95^\circ\text{C}$		
$I_{TSM}$	Non repetitive surge peak on-state current (full cycle, $T_j$ initial = $25^\circ\text{C}$ )	F = 50 Hz t = 20 ms	100	A
		F = 60 Hz t = 16.7 ms		
$I^2t$	$I^2t$ Value for fusing $t_p = 10$ ms		55	A <sup>2</sup> s
di/dt	Critical rate of rise of on-state current $I_G = 2 \times I_{GT}$ , $t_r \leq 100$ ns	F = 120 Hz $T_j = 125^\circ\text{C}$	50	A/ $\mu\text{s}$
$V_{DSM}/V_{RSM}$	Non repetitive surge peak off-state voltage	$t_p = 10$ ms $T_j = 25^\circ\text{C}$	$V_{DSM}/V_{RSM} + 100$	V
$I_{GM}$	Peak gate current	$t_p = 20$ $\mu\text{s}$ $T_j = 125^\circ\text{C}$	4	A
$P_{G(AV)}$	Average gate power dissipation	$T_j = 125^\circ\text{C}$	1	W
$T_{stg}$ $T_j$	Storage junction temperature range Operating junction temperature range		- 40 to + 150 - 40 to + 125	$^\circ\text{C}$

## BTA10 and BTB10 Series

**Tables 4: Electrical Characteristics** ( $T_j = 25^\circ\text{C}$ , unless otherwise specified)

### ■ SNUBBERLESS (3 quadrants)

Symbol	Test Conditions	Quadrant		BTA10 / BTB10		Unit
				CW	BW	
$I_{GT}$ (1)	$V_D = 12\text{ V}$ $R_L = 33\ \Omega$	I - II - III	MAX.	35	50	mA
$V_{GT}$		I - II - III	MAX.	1.3		V
$V_{GD}$	$V_D = V_{DRM}$ $R_L = 3.3\ \text{k}\Omega$ $T_j = 125^\circ\text{C}$	I - II - III	MIN.	0.2		V
$I_H$ (2)	$I_T = 500\ \text{mA}$		MAX.	35	50	mA
$I_L$	$I_G = 1.2 I_{GT}$	I - III	MAX.	50	70	mA
		II		60	80	
$dV/dt$ (2)	$V_D = 67\ \%V_{DRM}$ gate open $T_j = 125^\circ\text{C}$		MIN.	500	1000	V/ $\mu\text{s}$
$(dI/dt)_c$ (2)	Without snubber $T_j = 125^\circ\text{C}$		MIN.	5.5	9.0	A/ms

### ■ Standard (4 quadrants)

Symbol	Test Conditions	Quadrant		BTA10 / BTB10		Unit
				C	B	
$I_{GT}$ (1)	$V_D = 12\text{ V}$ $R_L = 33\ \Omega$	I - II - III IV	MAX.	25 50	50 100	mA
$V_{GT}$		ALL	MAX.	1.3		V
$V_{GD}$	$V_D = V_{DRM}$ $R_L = 3.3\ \text{k}\Omega$ $T_j = 125^\circ\text{C}$	ALL	MIN.	0.2		V
$I_H$ (2)	$I_T = 500\ \text{mA}$		MAX.	25	50	mA
$I_L$	$I_G = 1.2 I_{GT}$	I - III - IV	MAX.	40	50	mA
		II		80	100	
$dV/dt$ (2)	$V_D = 67\ \%V_{DRM}$ gate open $T_j = 125^\circ\text{C}$		MIN.	200	400	V/ $\mu\text{s}$
$(dV/dt)_c$ (2)	$(dI/dt)_c = 4.4\ \text{A/ms}$ $T_j = 125^\circ\text{C}$		MIN.	5	10	V/ $\mu\text{s}$

**Table 5: Static Characteristics**

Symbol	Test Conditions			Value	Unit
$V_T$ (2)	$I_{TM} = 14\ \text{A}$ $t_p = 380\ \mu\text{s}$	$T_j = 25^\circ\text{C}$	MAX.	1.55	V
$V_{t0}$ (2)	Threshold voltage	$T_j = 125^\circ\text{C}$	MAX.	0.85	V
$R_d$ (2)	Dynamic resistance	$T_j = 125^\circ\text{C}$	MAX.	40	$\text{m}\Omega$
$I_{DRM}$ $I_{RRM}$	$V_{DRM} = V_{RRM}$	$T_j = 25^\circ\text{C}$	MAX.	5	$\mu\text{A}$
		$T_j = 125^\circ\text{C}$		1	mA

**Note 1:** minimum  $I_{GT}$  is guaranteed at 5% of  $I_{GT}$  max.

**Note 2:** for both polarities of A2 referenced to A1.

Table 6: Thermal resistance

Symbol	Parameter		Value	Unit
$R_{th(j-c)}$	Junction to case (AC)	TO-220AB	1.5	$^{\circ}\text{C}/\text{W}$
		TO-220AB Insulated	2.4	
$R_{th(j-a)}$	Junction to ambient	TO-220AB	60	$^{\circ}\text{C}/\text{W}$
		TO-220AB Insulated		

Figure 1: Maximum power dissipation versus RMS on-state current (full cycle)

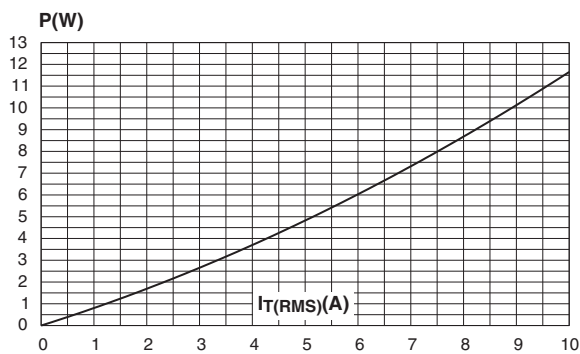

Figure 2: RMS on-state current versus case temperature (full cycle)

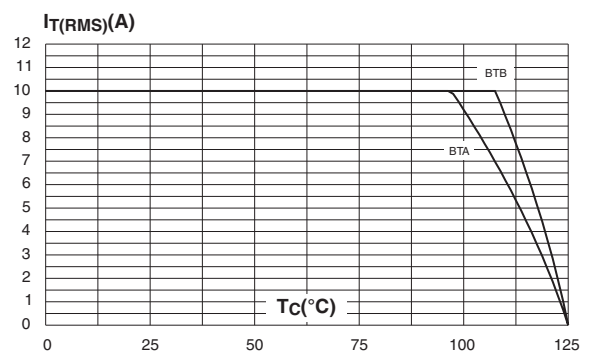

Figure 3: Relative variation of thermal impedance versus pulse duration

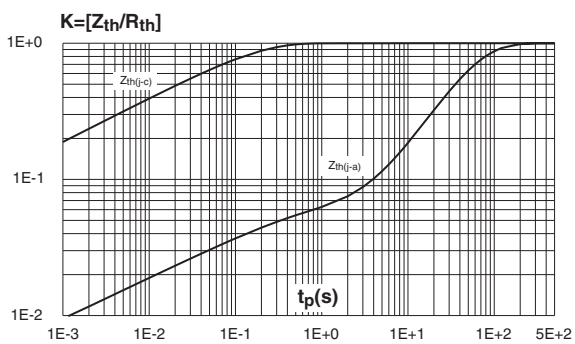

Figure 4: On-state characteristics (maximum values)

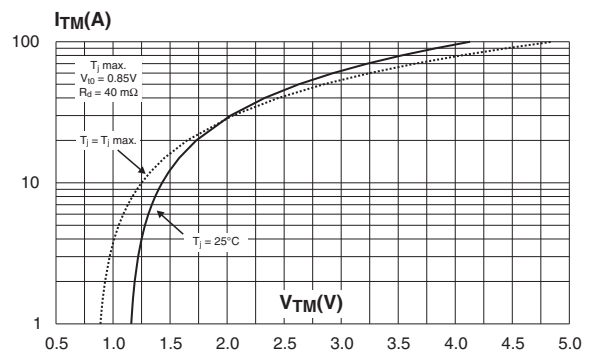

Figure 5: Surge peak on-state current versus number of cycles

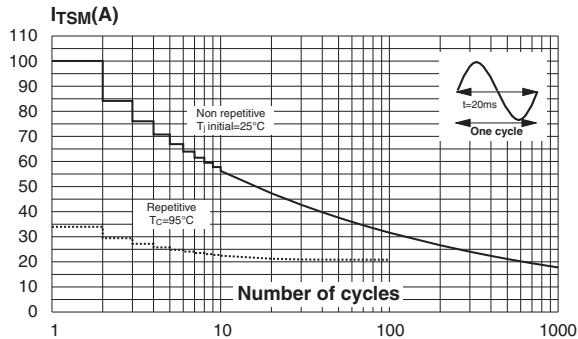

Figure 6: Non-repetitive surge peak on-state current for a sinusoidal pulse with width  $t_p < 10$  ms and corresponding value of  $I^2t$

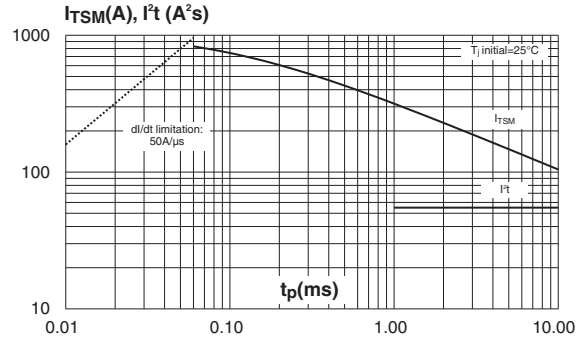

Figure 7: Relative variation of gate trigger current, holding current and latching current versus junction temperature (typical values)

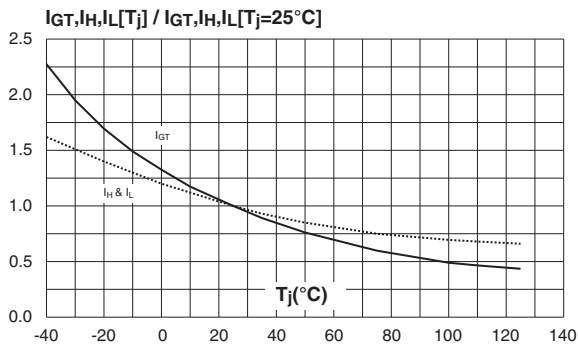

Figure 8: Relative variation of critical rate of decrease of main current versus  $(dV/dt)_c$  (typical values)

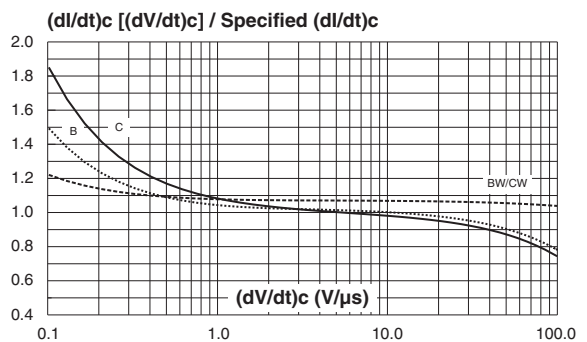

Figure 9: Relative variation of critical rate of decrease of main current versus junction temperature

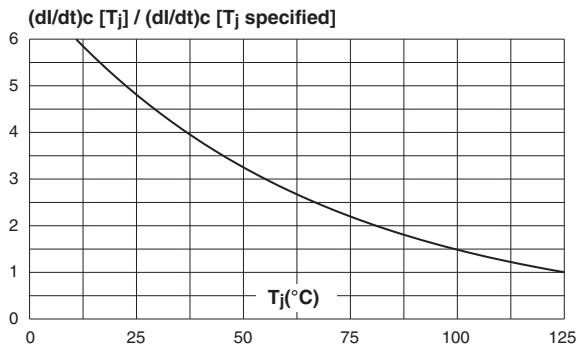

Figure 10: Ordering Information Scheme

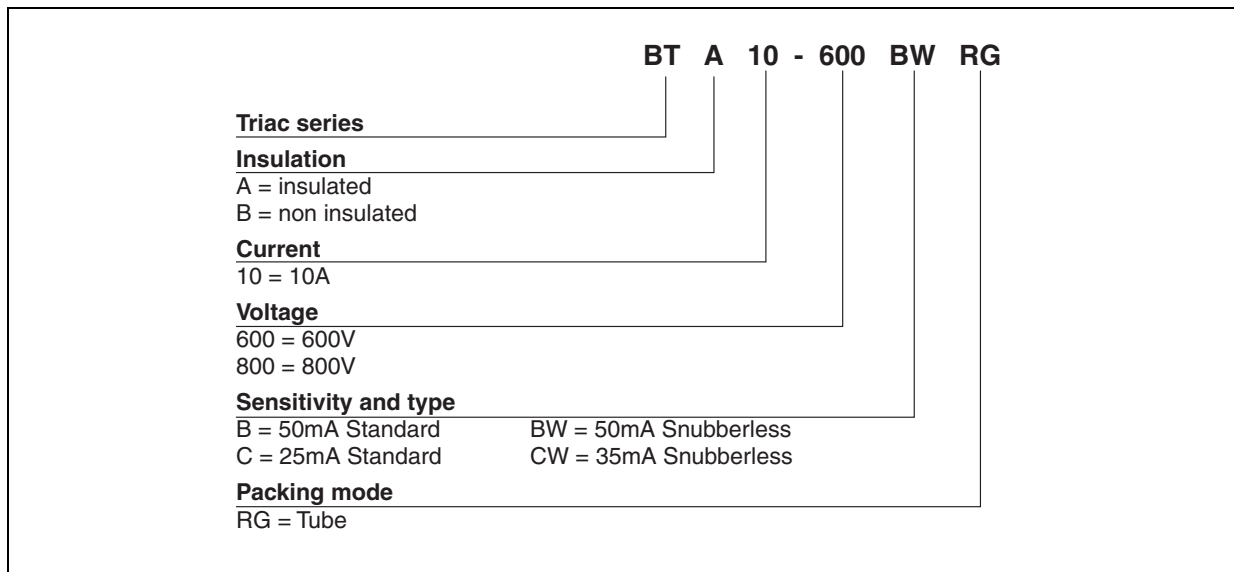

Table 7: Product Selector

Part Number	Voltage (xxx)		Sensitivity	Type	Package
	600 V	800 V			
BTA/BTB10-xxxB	X	X	50 mA	Standard	TO-220AB
BTA/BTB10-xxxBW	X	X	50 mA	Snubberless	TO-220AB
BTA/BTB10-xxxC	X	X	25 mA	Standard	TO-220AB
BTA/BTB10-xxxCW	X	X	35 mA	Snubberless	TO-220AB

**BTB:** non insulated TO-220AB package

## BTA10 and BTB10 Series

Figure 11: TO-220AB (insulated and non insulated) Package Mechanical Data

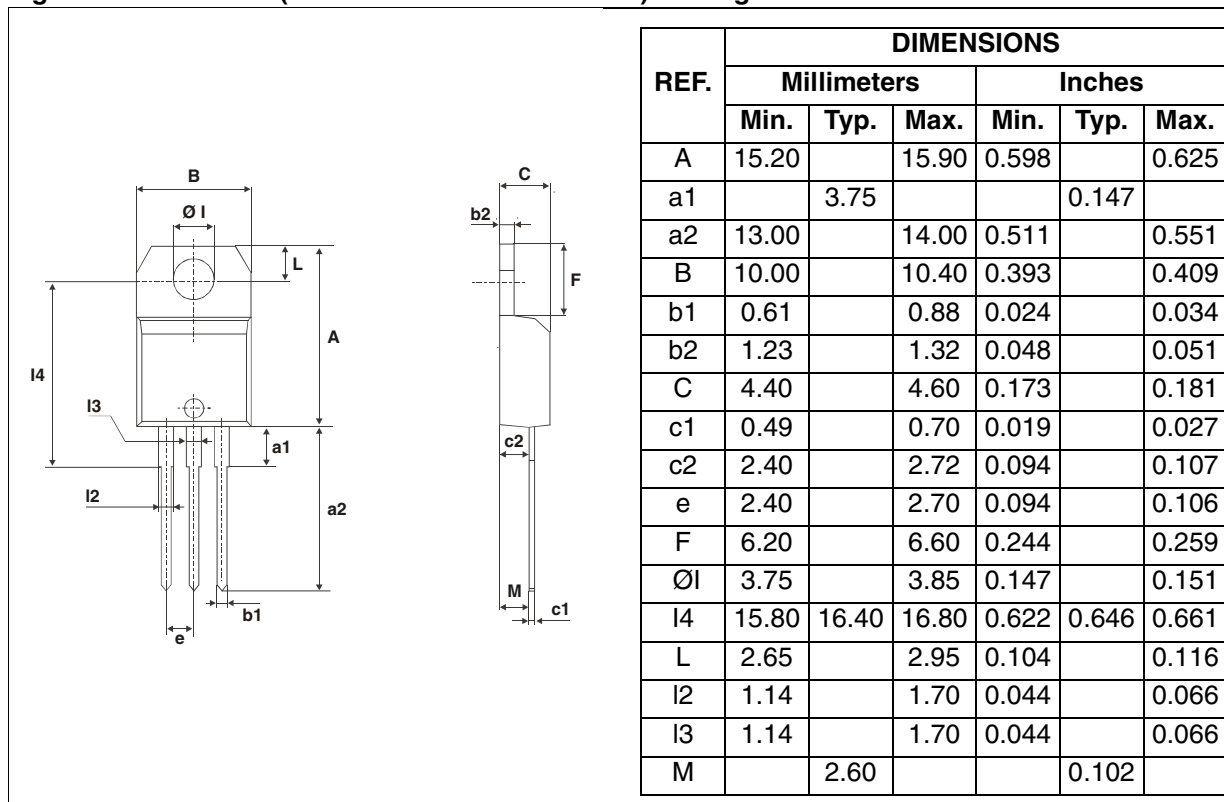

In order to meet environmental requirements, ST offers these devices in ECOPACK® packages. These packages have a Lead-free second level interconnect. The category of second level interconnect is marked on the package and on the inner box label, in compliance with JEDEC Standard JESD97. The maximum ratings related to soldering conditions are also marked on the inner box label. ECOPACK is an ST trademark. ECOPACK specifications are available at: [www.st.com](http://www.st.com).

Table 8: Ordering Information

Ordering type	Marking	Package	Weight	Base qty	Delivery mode
BTA/BTB10-xxxzyRG	BTA/BTB10-xxxzyz	TO-220AB	2.3 g	50	Tube

Note: xxx = voltage, yy = sensitivity, z = type

Table 9: Revision History

Date	Revision	Description of Changes
Apr-2002	5A	Last update.
13-Feb-2006	6	TO-220AB delivery mode changed from bulk to tube. ECOPACK statement added.

Information furnished is believed to be accurate and reliable. However, STMicroelectronics assumes no responsibility for the consequences of use of such information nor for any infringement of patents or other rights of third parties which may result from its use. No license is granted by implication or otherwise under any patent or patent rights of STMicroelectronics. Specifications mentioned in this publication are subject to change without notice. This publication supersedes and replaces all information previously supplied. STMicroelectronics products are not authorized for use as critical components in life support devices or systems without express written approval of STMicroelectronics.

The ST logo is a registered trademark of STMicroelectronics.  
All other names are the property of their respective owners

© 2006 STMicroelectronics - All rights reserved

**STMicroelectronics group of companies**

Australia - Belgium - Brazil - Canada - China - Czech Republic - Finland - France - Germany - Hong Kong - India - Israel - Italy - Japan -  
Malaysia - Malta - Morocco - Singapore - Spain - Sweden - Switzerland - United Kingdom - United States of America  
[www.st.com](http://www.st.com)