

# Power management (dual transistors)

## EMF9

2SC5585 and 2SK3019 are housed independently in a EMT6 package.

### ●Application

Power management circuit

### ●Features

- 1) Power switching circuit in a single package.
- 2) Mounting cost and area can be cut in half.

### ●Structure

Silicon epitaxial planar transistor

### ●Equivalent circuits

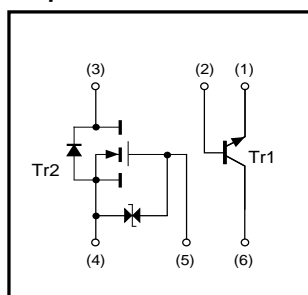

### ●External dimensions (Units : mm)

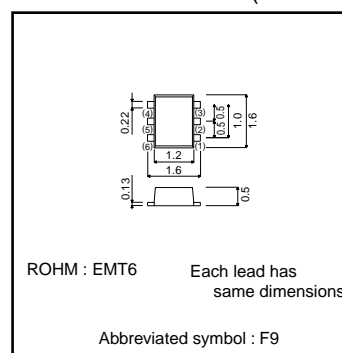

### ●Packaging specifications

Type	EMF9
Package	EMT6
Marking	F9
Code	T2R
Basic ordering unit (pieces)	8000

## Transistors

## ●Absolute maximum ratings (Ta=25°C)

Tr1

Parameter	Symbol	Limits	Unit
Collector-base voltage	V <sub>CB0</sub>	15	V
Collector-emitter voltage	V <sub>CE0</sub>	12	V
Emitter-base voltage	V <sub>EB0</sub>	6	V
Collector current	I <sub>c</sub>	500	mA
	I <sub>CP</sub>	1.0	A *
Junction temperature	T <sub>j</sub>	150	°C
Range of storage temperature	T <sub>stg</sub>	-55~+150	°C

\* Single pulse P<sub>w</sub>=1ms

Tr2

Parameter	Symbol	Limits	Unit
Drain-source voltage	V <sub>DSS</sub>	30	V
Gate-source voltage	V <sub>GSS</sub>	±20	V
Drain current	Continuous I <sub>d</sub>	100	mA
	Pulsed I <sub>DP</sub>	200	mA *
Reverse drain current	Continuous I <sub>DR</sub>	100	mA
	Pulsed I <sub>DRP</sub>	200	mA *
Channel temperature	T <sub>ch</sub>	150	°C
Range of storage temperature	T <sub>stg</sub>	-55~+150	°C

\* P<sub>w</sub>≤10ms Duty cycles≤50%

Tr1, Tr2

Parameter	Symbol	Limits	Unit
Total power dissipation	P <sub>D</sub>	150(TOTAL)	mW *

\* 120mW per element must not be exceeded. Each terminal mounted on a recommended land.

## ●Electrical characteristics (Ta=25°C)

Tr1

Parameter	Symbol	Min.	Typ.	Max.	Unit	Conditions
Collector-emitter breakdown voltage	BV <sub>CE0</sub>	12	–	–	V	I <sub>c</sub> =1mA
Collector-base breakdown voltage	BV <sub>CB0</sub>	15	–	–	V	I <sub>c</sub> =10μA
Emitter-base breakdown voltage	BV <sub>EB0</sub>	6	–	–	V	I <sub>E</sub> =10μA
Collector cut-off current	I <sub>CB0</sub>	–	–	100	nA	V <sub>CB</sub> =15V
Emitter cut-off current	I <sub>EB0</sub>	–	–	100	nA	V <sub>EB</sub> =6V
Collector-emitter saturation voltage	V <sub>CE(sat)</sub>	–	100	250	mV	I <sub>c</sub> =200mA, I <sub>B</sub> =10mA
DC current gain	h <sub>FE</sub>	270	–	680	–	V <sub>CE</sub> =2V, I <sub>c</sub> =10mA
Transition frequency	f <sub>r</sub>	–	320	–	MHz	V <sub>CE</sub> =2V, I <sub>E</sub> =-10mA, f=100MHz
Collector output capacitance	C <sub>ob</sub>	–	7.5	–	pF	V <sub>CB</sub> =10V, I <sub>E</sub> =0mA, f=1MHz

Tr2

Parameter	Symbol	Min.	Typ.	Max.	Unit	Conditions
Gate-source leakage	I <sub>GSS</sub>	–	–	±1	μA	V <sub>GS</sub> =±20V, V <sub>DS</sub> =0V
Drain-source breakdown voltage	V <sub>(BR)DSS</sub>	30	–	–	V	I <sub>D</sub> =10μA, V <sub>GS</sub> =0V
Zero gate voltage drain current	I <sub>DSS</sub>	–	–	1.0	μA	V <sub>DS</sub> =30V, V <sub>GS</sub> =0V
Gate-threshold voltage	V <sub>GS(th)</sub>	0.8	–	1.5	V	V <sub>DS</sub> =3V, I <sub>D</sub> =100μA
Static drain-source on-state resistance	R <sub>DS(on)</sub>	–	5	8	Ω	I <sub>D</sub> =10mA, V <sub>GS</sub> =4V
		–	7	13	Ω	I <sub>D</sub> =1mA, V <sub>GS</sub> =2.5V
Forward transfer admittance	Y <sub>fs</sub>	20	–	–	mS	V <sub>DS</sub> =3V, I <sub>D</sub> =10mA
Input capacitance	C <sub>iss</sub>	–	13	–	pF	V <sub>DS</sub> =5V, V <sub>GS</sub> =0V, f=1MHz
Output capacitance	C <sub>oss</sub>	–	9	–	pF	
Reverse transfer capacitance	C <sub>rss</sub>	–	4	–	pF	
Turn-on delay time	t <sub>d(on)</sub>	–	15	–	ns	I <sub>D</sub> =10mA, V <sub>DD</sub> ≐5V, V <sub>GS</sub> =5V, R <sub>L</sub> =500Ω, R <sub>GS</sub> =10Ω
Rise time	t <sub>r</sub>	–	35	–	ns	
Turn-off delay time	t <sub>d(off)</sub>	–	80	–	ns	
Fall time	t <sub>f</sub>	–	80	–	ns	

Transistors

●Electrical characteristic curves

Tr1

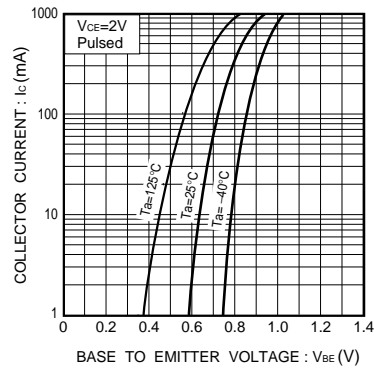

Fig.1 Grounded emitter propagation characteristics

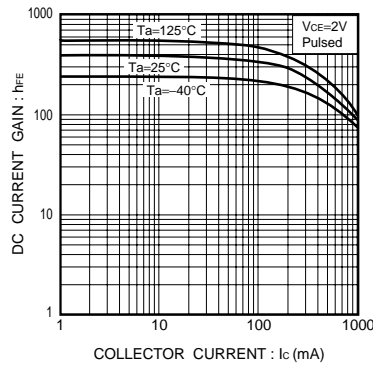

Fig.2 DC current gain vs. collector current

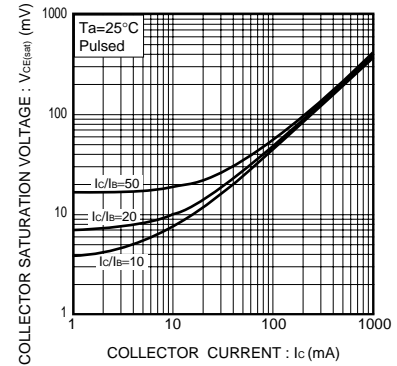

Fig.3 Collector-emitter saturation voltage vs. collector current ( I )

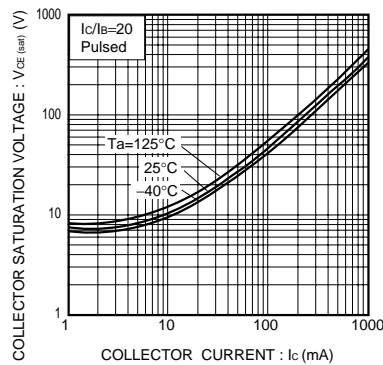

Fig.4 Collector-emitter saturation voltage vs. collector current ( II )

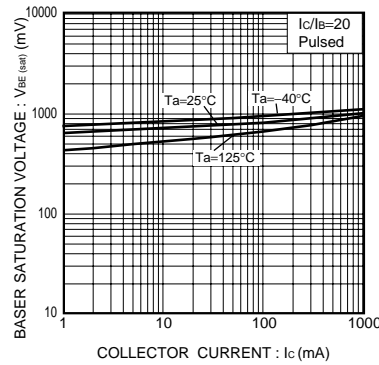

Fig.5 Base-emitter saturation voltage vs. collector current

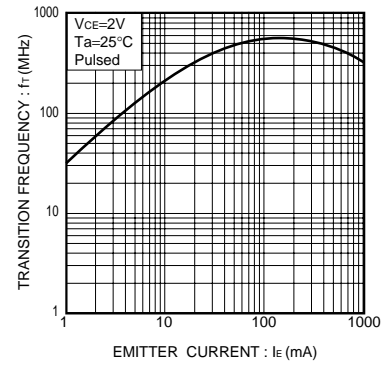

Fig.6 Gain bandwidth product vs. emitter current

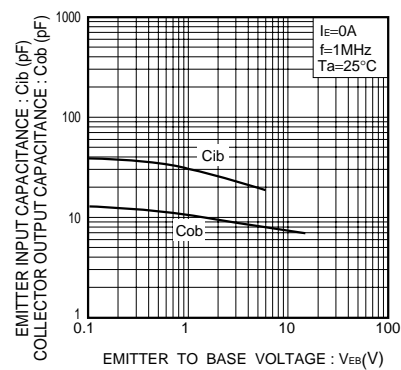

Fig.7 Collector output capacitance vs. collector-base voltage  
Emitter input capacitance vs. emitter-base voltage

Transistors

Tr2

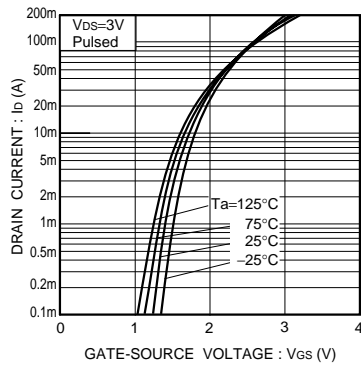

Fig.9 Typical transfer characteristics

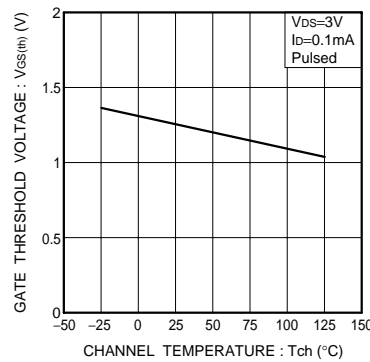

Fig.10 Gate threshold voltage vs. channel temperature

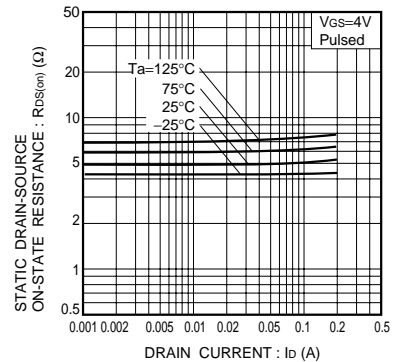

Fig.11 Static drain-source on-state resistance vs. drain current ( I )

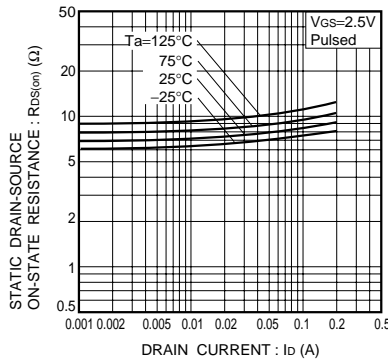

Fig.12 Static drain-source on-state resistance vs. drain current ( II )

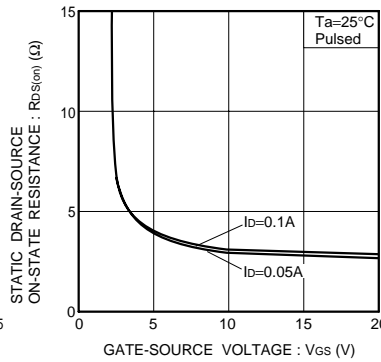

Fig.13 Static drain-source on-state resistance vs. gate-source voltage

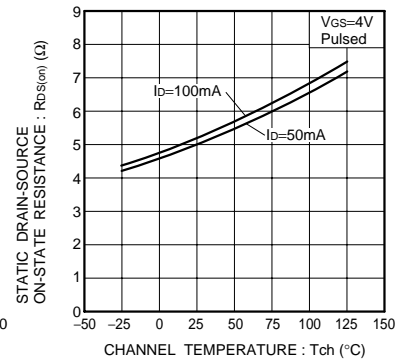

Fig.14 Static drain-source on-state resistance vs. channel temperature

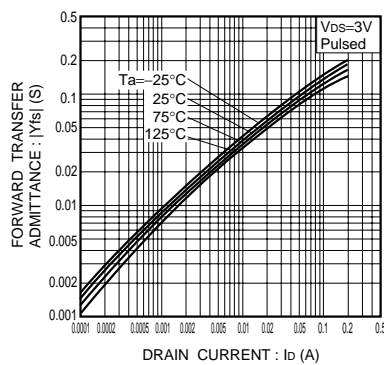

Fig.15 Forward transfer admittance vs. drain current

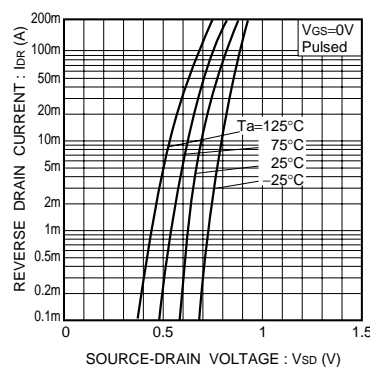

Fig.16 Reverse drain current vs. source-drain voltage ( I )

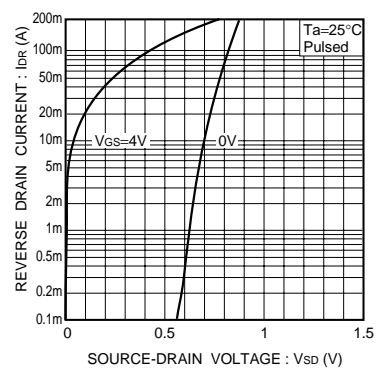

Fig.17 Reverse drain current vs. source-drain voltage ( II )

## Transistors

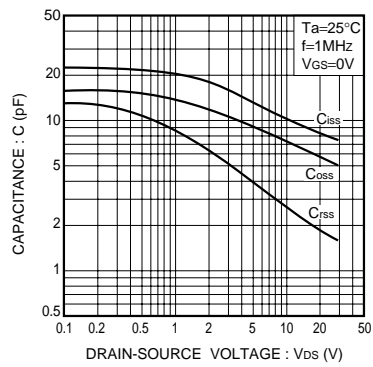

Fig.18 Typical capacitance vs. drain-source voltage

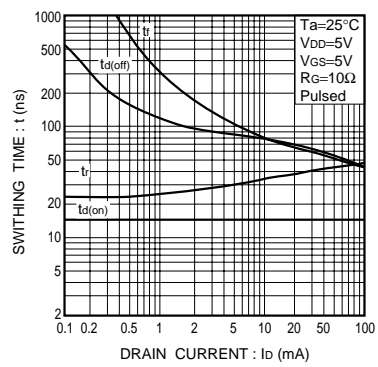

Fig.19 Switching characteristics