

# Monitoring Relays

## True RMS 3-Phase, 3-Phase+N, Multi-function

### Types DPB01, PPB01

CARLO GAVAZZI



DPB01



PPB01

- TRMS 3-phase over and under voltage, phase sequence and phase loss monitoring relays
- Detect when all 3 phases are present and have the correct phase sequence (except for N versions)
- Available versions (W4) supplied between phase and neutral
- Detect if all the 3-phase-phase or phase-neutral voltages are within the set limits
- Upper and lower limits separately adjustable
- Measure on own power supply
- Selection of measuring range by DIP-switches
- Adjustable voltage on relative scale
- Adjustable delay function (0.1 to 30 s)
- Output: 8 A SPDT relay N.E.
- For mounting on DIN-rail in accordance with DIN/EN 50 022 (DPB01) or plug-in module (PPB01)
- 22.5 mm Euronorm housing (DPB01) or 36 mm plug-in module (PPB01)
- LED indication for relay, alarm and power supply ON

## Product Description

3-phase or 3-phase+neutral line voltage monitoring relay for phase sequence, phase loss, over and under voltage (separately adjustable set

points) with built-in time delay function.

Supply ranges from 208 to 480 VAC covered by two multivoltage relays.

## Ordering Key

**DPB 01 C M23**

Housing \_\_\_\_\_  
 Function \_\_\_\_\_  
 Type \_\_\_\_\_  
 Item number \_\_\_\_\_  
 Output \_\_\_\_\_  
 Power supply \_\_\_\_\_

## Type Selection

Mounting	Phase sequence detection	Output	Supply: 208 to 240 VAC	Supply: 380 to 415 VAC	Supply: 380 to 480 VAC
DIN-rail	yes	SPDT	<b>DPB 01 C M23</b>	<b>DPB 01 C M48 W4</b>	<b>DPB 01 C M48</b>
Plug-in	yes	SPDT	<b>PPB 01 C M23</b>	<b>PPB 01 C M48 W4</b>	
Plug-in	yes	SPDT		<b>PPB 01 C M48</b>	
DIN-rail	no	SPDT	<b>DPB 01 C M23 N</b>	<b>DPB 01 C M48 N W4</b>	<b>DPB 01 C M48 N</b>
Plug-in	no	SPDT	<b>PPB 01 C M23 N</b>	<b>PPB 01 C M48 N W4</b>	
Plug-in	no	SPDT		<b>PPB 01 C M48 N</b>	

## Input Specifications

Input	DPB01: Terminals L1, L2, L3, N PPB01: Terminals 5, 6, 7, 11 Measure on own supply	Ranges	
L1, L2, L3, N		Upper level	+2 to +22% of the nominal voltage
		Lower level	-22 to -2% of the nominal voltage
Note: Connect the neutral only if it is intrinsically at the star centre		<b>Note:</b> The input voltage must not exceed the maximum rated voltage or drop below the minimum rated voltage reported above.	
<b>Measuring ranges</b>		<b>Hysteresis</b>	
208 to 240 VAC	177 to 275 V <sub>L-L</sub> AC M23 versions	Set points from 2 to 5%	1%
380 to 415 VAC	323 to 475 V <sub>L-L</sub> AC PPB01CM48 PPB01CM48N D/P PB01CM48W4 D/P PB01CM48NW4	Set points from 5 to 22%	2%
380 to 480 VAC	323 to 550 V <sub>L-L</sub> AC DPB01CM48 DPB01CM48N		

## Output Specifications

<b>Output</b> Rated insulation voltage	SPDT relay 250 VAC
<b>Contact ratings</b> (AgSnO <sub>2</sub> ) Resistive loads AC 1 DC 12 Small inductive loads AC 15 DC 13	μ 8 A @ 250 VAC 5 A @ 24 VDC 2.5 A @ 250 VAC 2.5 A @ 24 VDC
<b>Mechanical life</b>	≥ 30 x 10 <sup>6</sup> operations
<b>Electrical life</b>	≥ 10 <sup>5</sup> operations (at 8 A, 250 V, cos φ = 1)
<b>Operating frequency</b>	≤ 7200 operations/h
<b>Dielectric strength</b> Dielectric voltage Rated impulse withstand volt.	2 kVAC (rms) 4 kV (1.2/50 μs)

## Supply Specifications

<b>Power supply</b> Rated operational voltage through terminals: L1, L2, L3, N (DPB01) 5, 6, 7, 11 (PPB01)  D/P PB01CM23, D/P PB01CM23N  D/P PB01CM48W4, D/P PB01CM48NW4, PPB01CM48, PPB01CM48N  DPB01CM48, DPB01CM48N	Overvoltage cat. III (IEC 60664, IEC 60038)  208 to 240 V <sub>L-L</sub> AC ±15% 45 to 65 Hz  380 to 415 V <sub>L-L</sub> AC ±15% (220 to 240 V <sub>L-N</sub> AC ±15%) 45 to 65 Hz  380 to 480 V <sub>L-L</sub> AC ±15% (220 to 277 V <sub>L-N</sub> AC ±15%) 45 to 65 Hz
<b>Rated operational power</b> DPB01CM23x, PPB01CM23x DPB01CM48x, PPB01CM48x  DPB01CM48xW4 DPB01CM48xW4	13 VA @ 230 ΔVAC, 50 Hz 13 VA @ 400 ΔVAC, 50 Hz Supplied by L1 and L2  13 VA @ 400 ΔVAC, 50 Hz Supplied by L1 and N

## General Specifications

<b>Power ON delay</b>	1 s ± 0.5 s or 6 s ± 0.5 s
<b>Reaction time</b> Incorrect phase sequence or total phase loss Voltage level  Alarm ON delay Alarm OFF delay	< 200 ms (input signal variation from -20% to +20% or from +20% to -20% of set value) < 200 ms (delay < 0.1 s) < 200 ms (delay < 0.1 s)
<b>Accuracy</b> Temperature drift Delay ON alarm Repeatability	(15 min warm-up time) ± 1000 ppm/°C ± 10% on set value ± 50 ms ± 0.5% on full-scale
<b>Indication for</b> Power supply ON Alarm ON  Output relay ON	LED, green LED, red (flashing 2 Hz during delay time) LED, yellow
<b>Environment</b> Degree of protection Pollution degree Operating temperature @ Max. voltage, 50 Hz @ Max. voltage, 60 Hz Storage temperature	IP 20 3 (DPB01), 2 (PPB01) -20 to 60°C, R.H. < 95% -20 to 50°C, R.H. < 95% -30 to 80°C, R.H. < 95%
<b>Housing</b> Dimensions DPB01 PPB01	22.5 x 80 x 99.5 mm 36 x 80 x 94 mm
<b>Weight</b>	Approx. 120 g
<b>Screw terminals</b> Tightening torque	Max. 0.5 Nm according to IEC 60947
<b>Approvals</b>	UL, CSA (except for W4 versions)
<b>CE Marking</b>	Yes
<b>EMC</b> Immunity Emissions	Electromagnetic Compatibility According to EN 61000-6-2 According to EN 61000-6-3

## Mode of Operation

Connected to the 3 phases (and neutral) DPB01 and PPB01 operate when all 3 phases are present at the same time, the phase sequence is correct (not N versions) and the phase-phase (or phase-neutral) voltage levels are within set limits.

If one or more phase-phase or phase-neutral voltages exceeds the upper set level or drops below the lower set level, the red LED starts

flashing 2 Hz and the output relay releases after the set time period. In any case if phase-neutral measurement is selected both phase-phase and phase-neutral voltages are monitored. If the phase sequence is wrong or one phase is lost, the output relay releases immediately.

Only 200 ms delay occurs. The failure is indicated by the red LED flashing 5 Hz during the alarm condition.

### Example 1 (mains network monitoring)

The relay monitors over and under voltage, phase loss and correct phase sequence. In case of N versions, the relay monitors over and under voltage.

### Example 2 (load monitoring)

The relay releases in case of interruption of one or more phases, when one or more voltages drop below the lower set level or exceed the upper set level.

## Function/Range/Level and Time Delay Setting

Adjust the input range setting the DIP switches 3 and 4 as shown below.

To access the DIP switches open the grey plastic cover as shown below

**Selection of level and time delay:**

**Centre knob:**  
Setting of upper level on relative scale.

Select the desired function setting the DIP switches 1 and 2 as shown below.

**Upper knob:**  
Setting of lower level on relative scale.

**Lower knob:**  
Setting of delay on alarm time on absolute scale (0.1 to 30 s).

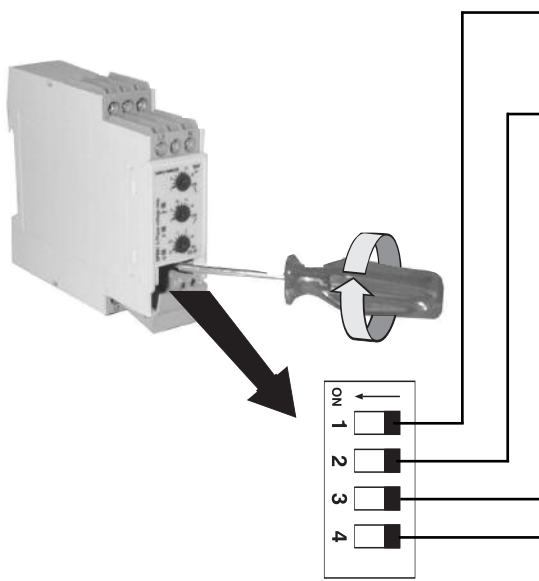

**Power ON delay**  
ON: 6 s ± 0.5 s  
OFF: 1 s ± 0.5 s

**Monitored voltage**  
ON: Phase-Neutral  
OFF: Phase-Phase

Measuring range				
SW3	ON	ON	OFF	OFF
SW4	ON	OFF	ON	OFF
M23 Ph-Ph Voltage	208 VAC	220 VAC	230 VAC	240 VAC
M48 Ph-Ph Voltage	380 VAC	400 VAC	415 VAC	480 VAC DPB01CM48, DPB01CM48N only
M48 Ph-N Voltage	220 VAC	230 VAC	240 VAC	277 VAC DPB01CM48, DPB01CM48N only

## Operation Diagrams

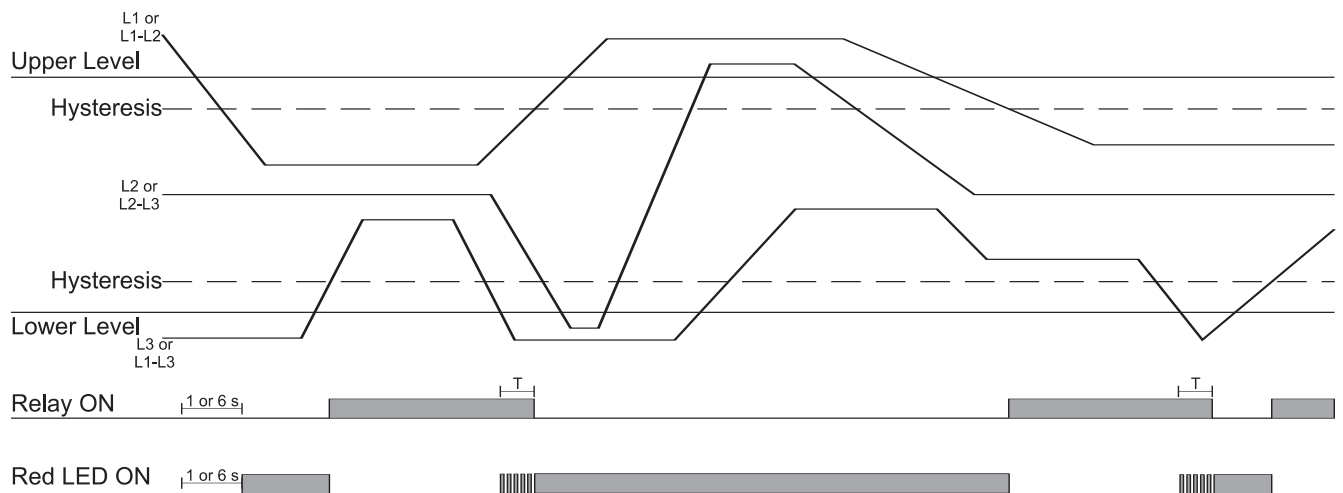

## Operation Diagrams (cont.)

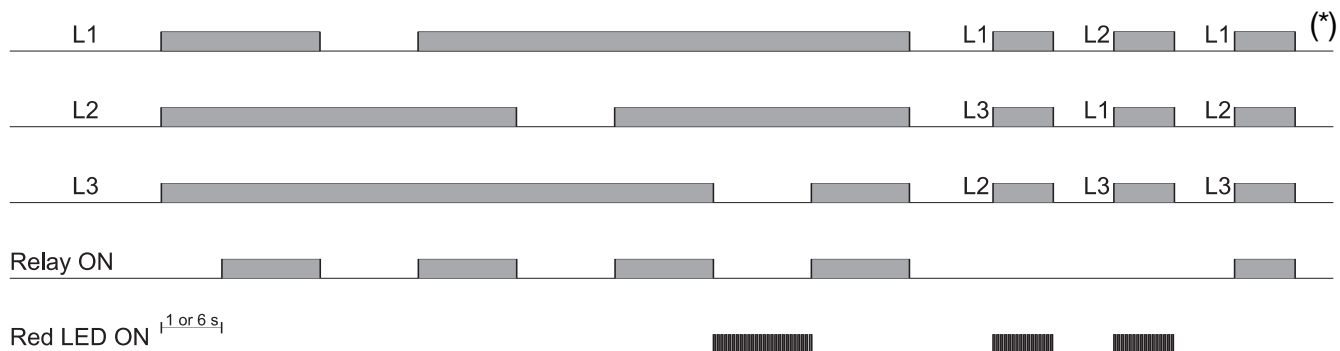

(\*) N versions don't detect incorrect phase sequence.

## Wiring Diagrams

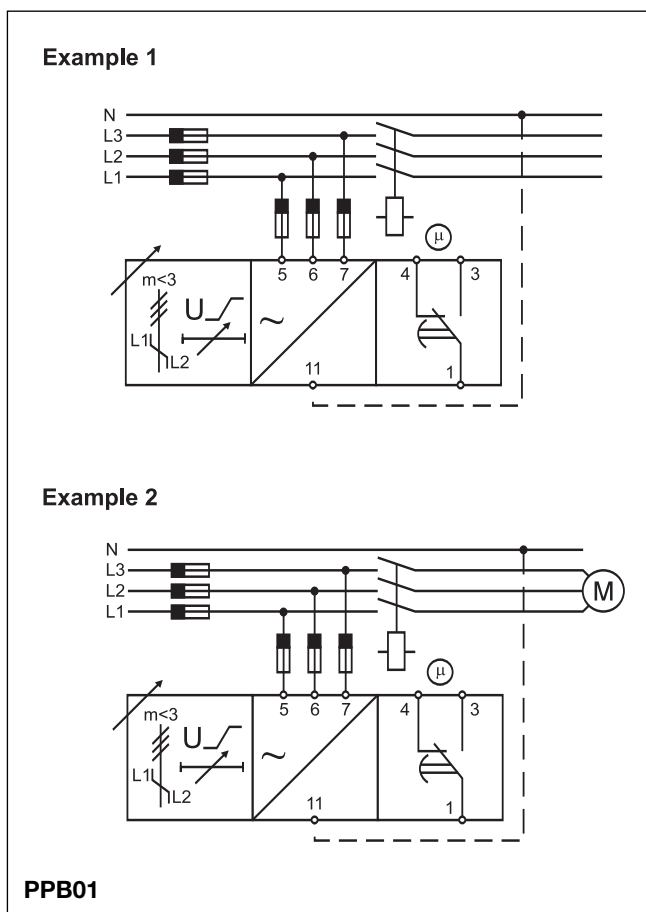
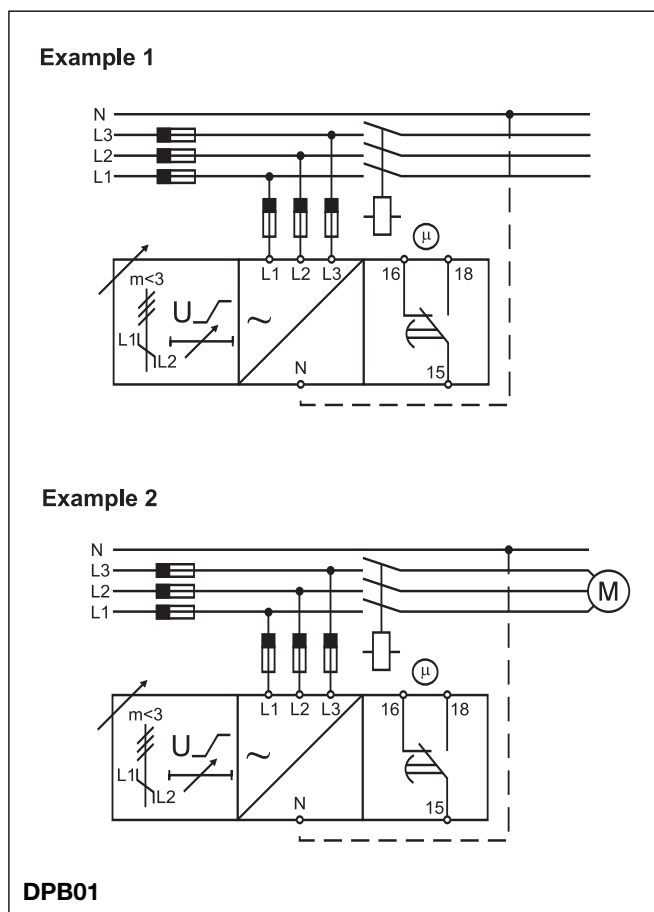

## Note

When DPB01 or PPB01 is used with phase indicator lamps (see examples in the following diagrams), the lamp H1 or H2 might be dimly lit when there is a phase loss in L1 or L2. This might happen if the lamps used are the typical low power indicator lamps, and there are no other loads present.

This fact can be avoided by using W4 models. Note that the neutral must be always connected to the device.

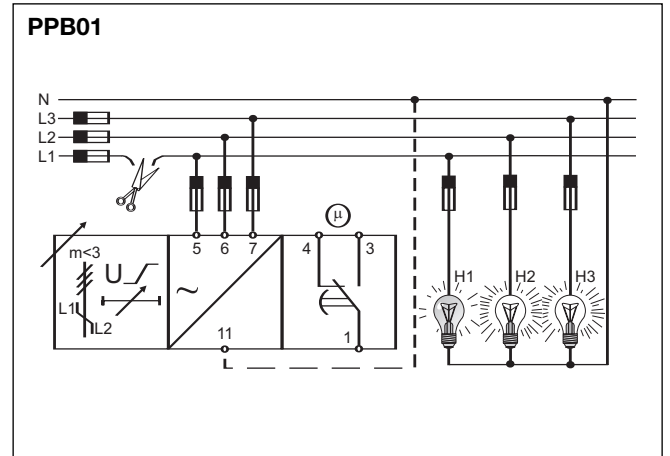
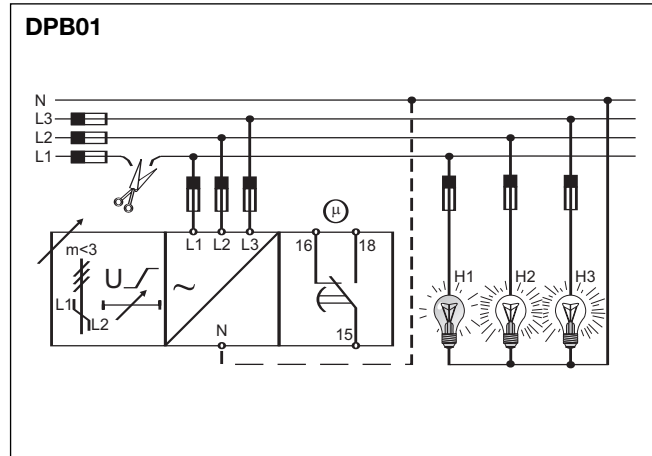

## Dimensions

