



Obsolescence Notice

This product is obsolete.

This information is available for your convenience only.

For more information on Zarlink's obsolete products and replacement product lists, please visit

http://products.zarlink.com/obsolete_products/

***THIS DOCUMENT IS FOR MAINTENANCE
PURPOSES ONLY AND IS NOT
RECOMMENDED FOR NEW DESIGNS***

SL1615

WIDEBAND LOG IF STRIP AMPLIFIER

The SL1615 is a bipolar monolithic integrated circuit wideband amplifier intended for use in successive detection logarithmic IF strips, operating at centre frequencies between 10MHz and 60MHz. The device provides amplification, limiting and rectification, is suitable for direct coupling and incorporates supply line decoupling. The mid-band voltage gain of the SL1615 is typically 12dB.

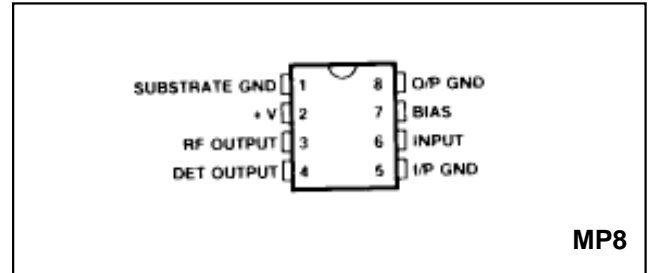

Fig.1 Pin connections - top view

FEATURES

- Well Defined Gain
- 4.5dB Noise Figure
- High I/P impedance
- Low O/P impedance
- 150MHz Bandwidth
- On-Chip Supply Decoupling
- Low External Component Count

APPLICATIONS

- Logarithmic IF Strips with Gains up to 108dB and Linearity Better than 2dB
- Low Cost Radar
- Radio Telephone Filed Strength Meters

ABSOLUTE MAXIMUM RATINGS

Storage temperature range	-55°C to +150°C
Operating temperature range	-30°C to +85°C
Thermal resistance	
Chip-to-ambient	163°C/W
Chip-to-case	57°C/W
Maximum instantaneous voltage	
at video output	+12V
Supply voltage	9V

ORDERING INFORMATION

SL1615 NA MP

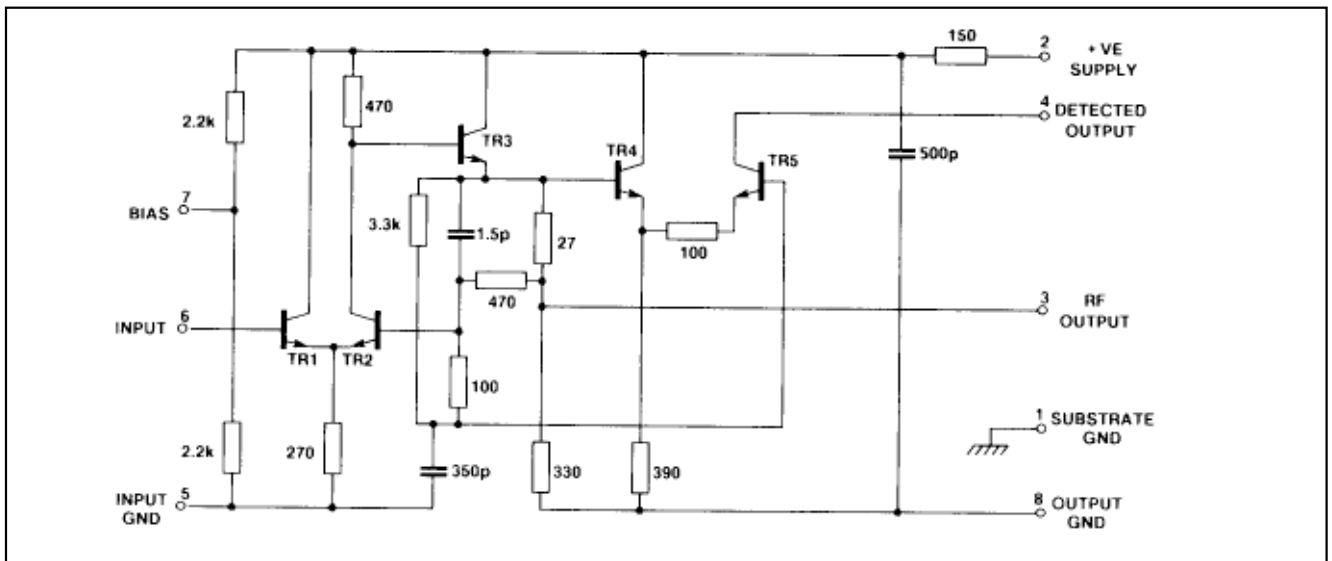

Fig.2 Circuit diagram

SL1615

ELECTRICAL CHARACTERISTICS

These characteristics are guaranteed over the following conditions (unless otherwise stated)

Temperature = +22°C ±2°C, Supply Voltage = +6V, DC Connection between Input and Bias Pins

Characteristic	Value			Units	Conditions
	Min.	Typ.	Max.		
Voltage Gain, f = 30MHz	10		14	dB	10Ω Source, 8pF Load
Voltage Gain, f = 60MHz	10.7		13.3	dB	10Ω Source, 8pF Load
Upper Cut-off frequency (Fig.3)	130	170		MHz	10Ω Source, 8pF Load
Lower Cut-off frequency (Fig.3)		5		MHz	10Ω Source, 8pF Load
Propagation Delay		2		ns	
Maximum rectified Video Output Current (Fig.4 and 5)	0.80		1.40	mA	f = 60MHz, 0.5V rms Input
Variation of Gain with Supply Voltage		0.7		db/V	
Variation of Maximum Rectified Output Current with Supply Voltage		25		%/V	
Maximum Input Signal before Overload	1.8	1.9		V/rms	See Note below
Noise Figure (Fig.6)		4		dB	f = 60MHz, Rs = 450Ω
Supply Current	11.5		20	mA	
Maximum RF Output Voltage		1.2		Vp-p	

Note: Overload occurs when the input signal reaches a level sufficient to forward bias the base-collector junction of TR1 on peaks

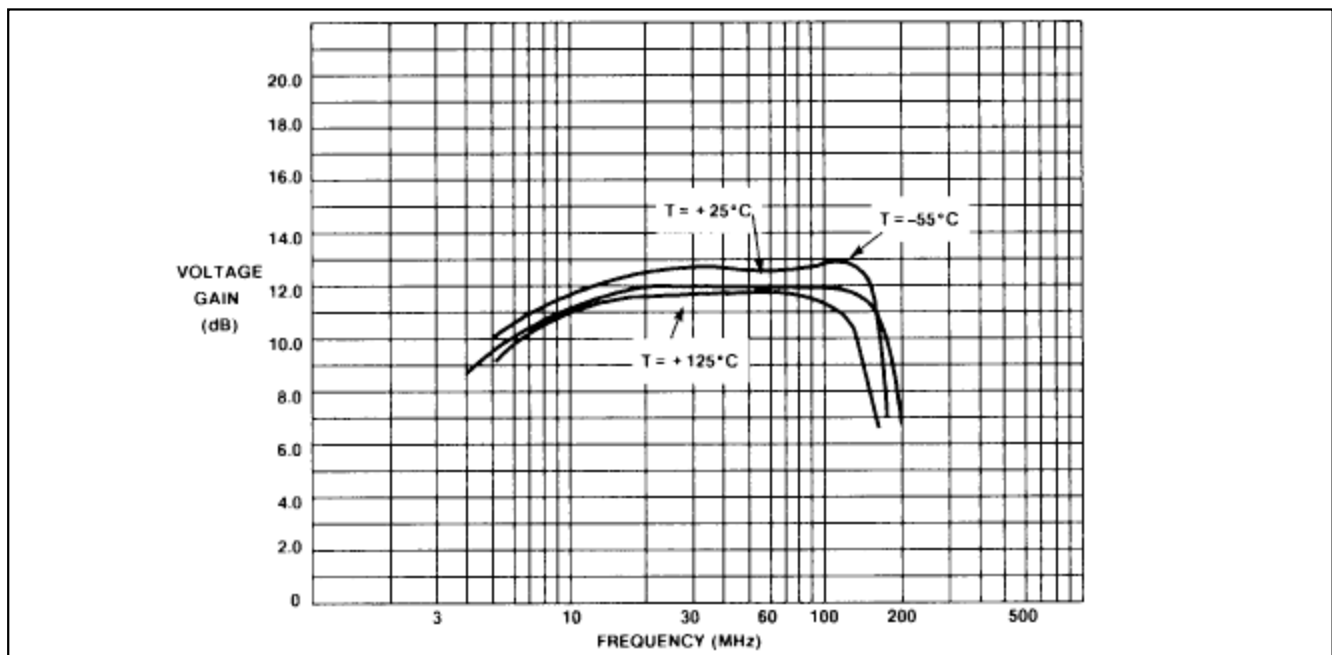

Fig.3 Voltage gain v. frequency

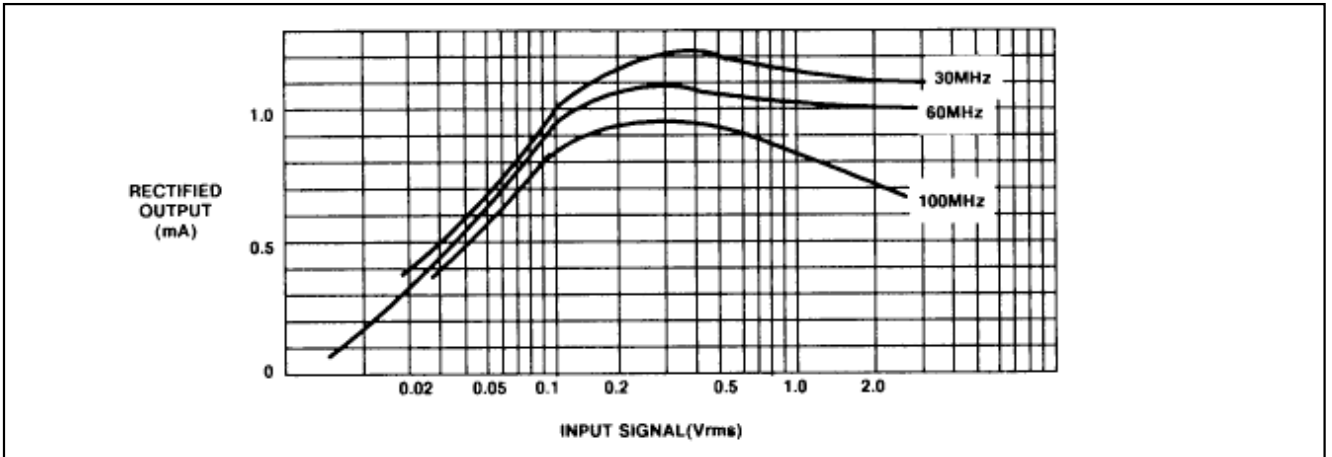

Fig.4 Rectified Output Current v. Input Signal

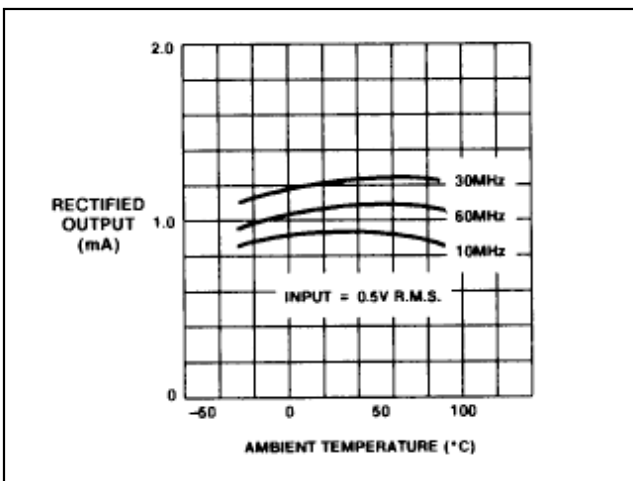

Fig.5 Maximum Rectified Output Current v. Temperature

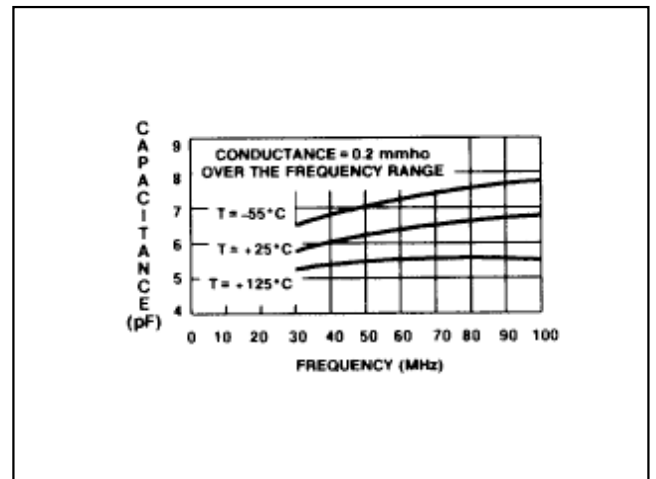

Fig.7 Input Admittance with Open Circuit Output

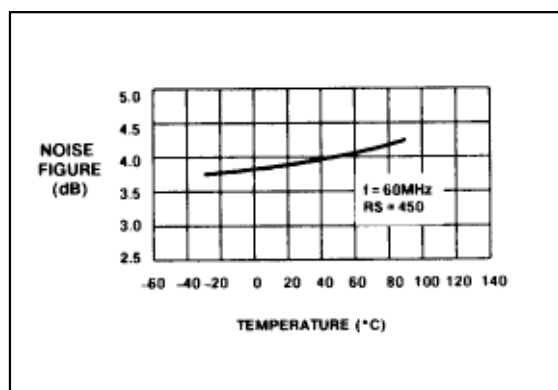

Fig.6 Typical Noise Figure v. Temperature

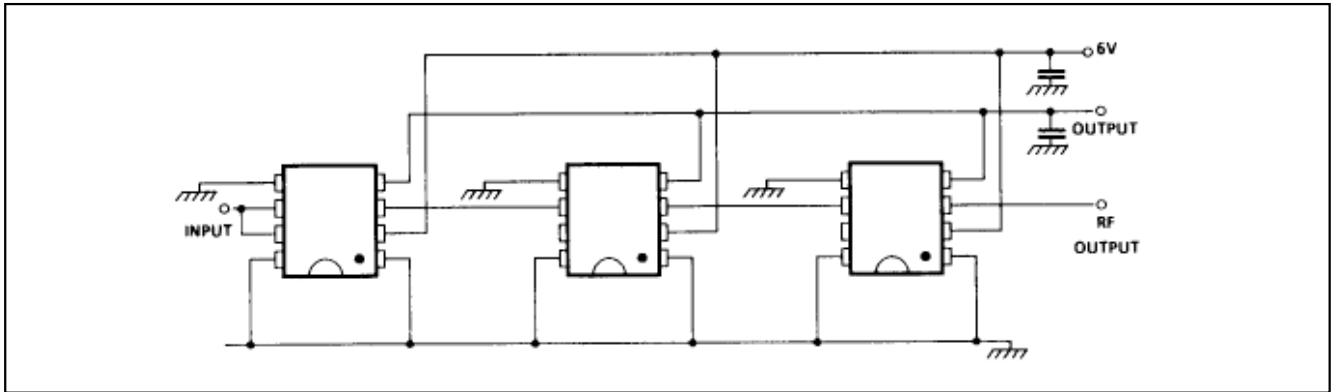

Fig.8 Direct coupled amplifiers

OPERATING NOTES

The amplifiers are intended for use directly coupled, as shown in Fig. 8.

The seventh stage in an untuned cascade will be giving virtually full output on noise.

Noise may be reduced by inserting a single tuned circuit in the chain. As there is a large mismatch between stages a simple parallel or series circuit cannot be used. This choice of network is also controlled by the need to avoid distorting the logarithmic law: the network must give unity voltage transfer at resonance. A suitable network is shown in Fig. 9. The value of C3 must be chosen so that at resonance its admittance equals the total loss conductance across the tuned circuit. Resistor R12 may be introduced to improve the symmetry of filter response, providing other values are adjusted for unity gain at resonance.

A single capacitor may not be suitable for decoupling the output line if many stages and fast rise times are required.

Values of supply line decoupling capacitor required for untuned cascades are given below. Smaller values can be used in high frequency tuned cascades.

The amplifiers have been provided with two ground leads to avoid the introduction of common ground lead inductance between input and output circuits. the equipment designer should take care to avoid the subsequent introduction of such inductance.

	Number of stages			
	6 or more	5	4	3
Minimum capacitance	30nF	10nF	3nF	1nF

The on-chip 500pF supply decoupling capacitor has a resistance of, typically 10Ω. It is a junction type having a low breakdown voltage and consequently the positive supply current will increase rapidly if the supply voltage exceeds 7.5V. (See Absolute Maximum Ratings).

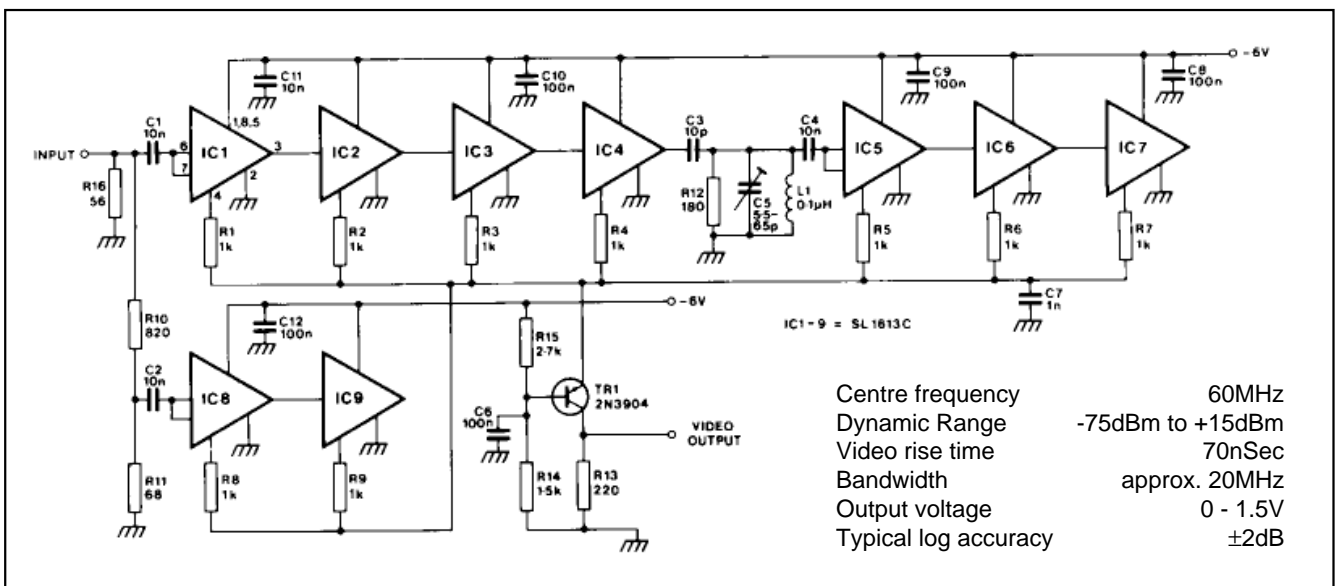

Centre frequency 60MHz
 Dynamic Range -75dBm to +15dBm
 Video rise time 70nSec
 Bandwidth approx. 20MHz
 Output voltage 0 - 1.5V
 Typical log accuracy ±2dB

Fig.9 Circuit diagram of low strip



HEADQUARTERS OPERATIONS

GEC PLESSEY SEMICONDUCTORS

Cheney Manor, Swindon,
Wiltshire SN2 2QW, United Kingdom.
Tel: (0793) 518000
Fax: (0793) 518411

GEC PLESSEY SEMICONDUCTORS

P.O. Box 660017
1500 Green Hills Road,
Scotts Valley, California 95067-0017,
United States of America.
Tel: (408) 438 2900
Fax: (408) 438 5576

CUSTOMER SERVICE CENTRES

- **FRANCE & BENELUX** Les Ulis Cedex Tel: (1) 64 46 23 45 Tx: 602858F
Fax : (1) 64 46 06 07
- **GERMANY** Munich Tel: (089) 3609 06-0 Tx: 523980 Fax : (089) 3609 06-55
- **ITALY** Milan Tel: (02) 66040867 Fax: (02) 66040993
- **JAPAN** Tokyo Tel: (03) 3296-0281 Fax: (03) 3296-0228
- **NORTH AMERICA Integrated Circuits and Microwave Products** Scotts Valley, USA
Tel (408) 438 2900 Fax: (408) 438 7023.
Hybrid Products, Farmingdale, USA Tel (516) 293 8686
Fax: (516) 293 0061.
- **SOUTH EAST ASIA** Singapore Tel: (65) 3827708 Fax: (65) 3828872
- **SWEDEN** Stockholm, Tel: 46 8 702 97 70 Fax: 46 8 640 47 36
- **UNITED KINGDOM & SCANDINAVIA**
Swindon Tel: (0793) 518510 Tx: 444410 Fax : (0793) 518582

These are supported by Agents and Distributors in major countries world-wide.

© GEC Plessey Semiconductors 1993 Publication No. DS3613 Issue No. 1.0 June 1993

This publication is issued to provide information only which (unless agreed by the Company in writing) may not be used, applied or reproduced for any purpose nor form part of any order or contract nor to be regarded as a representation relating to the products or services concerned. No warranty or guarantee express or implied is made regarding the capability, performance or suitability of any product or service. The Company reserves the right to alter without prior knowledge the specification, design or price of any product or service. Information concerning possible methods of use is provided as a guide only and does not constitute any guarantee that such methods of use will be satisfactory in a specific piece of equipment. It is the user's responsibility to fully determine the performance and suitability of any equipment using such information and to ensure that any publication or data used is up to date and has not been superseded. These products are not suitable for use in any medical products whose failure to perform may result in significant injury or death to the user. All products and materials are sold and services provided subject to the Company's conditions of sale, which are available on request.



**For more information about all Zarlink products
visit our Web Site at
www.zarlink.com**

Information relating to products and services furnished herein by Zarlink Semiconductor Inc. or its subsidiaries (collectively "Zarlink") is believed to be reliable. However, Zarlink assumes no liability for errors that may appear in this publication, or for liability otherwise arising from the application or use of any such information, product or service or for any infringement of patents or other intellectual property rights owned by third parties which may result from such application or use. Neither the supply of such information or purchase of product or service conveys any license, either express or implied, under patents or other intellectual property rights owned by Zarlink or licensed from third parties by Zarlink, whatsoever. Purchasers of products are also hereby notified that the use of product in certain ways or in combination with Zarlink, or non-Zarlink furnished goods or services may infringe patents or other intellectual property rights owned by Zarlink.

This publication is issued to provide information only and (unless agreed by Zarlink in writing) may not be used, applied or reproduced for any purpose nor form part of any order or contract nor to be regarded as a representation relating to the products or services concerned. The products, their specifications, services and other information appearing in this publication are subject to change by Zarlink without notice. No warranty or guarantee express or implied is made regarding the capability, performance or suitability of any product or service. Information concerning possible methods of use is provided as a guide only and does not constitute any guarantee that such methods of use will be satisfactory in a specific piece of equipment. It is the user's responsibility to fully determine the performance and suitability of any equipment using such information and to ensure that any publication or data used is up to date and has not been superseded. Manufacturing does not necessarily include testing of all functions or parameters. These products are not suitable for use in any medical products whose failure to perform may result in significant injury or death to the user. All products and materials are sold and services provided subject to Zarlink's conditions of sale which are available on request.

Purchase of Zarlink's I²C components conveys a licence under the Philips I²C Patent rights to use these components in and I²C System, provided that the system conforms to the I²C Standard Specification as defined by Philips.

Zarlink, ZL and the Zarlink Semiconductor logo are trademarks of Zarlink Semiconductor Inc.

Copyright Zarlink Semiconductor Inc. All Rights Reserved.

TECHNICAL DOCUMENTATION - NOT FOR RESALE
