

## Single Phase Rectifier Bridge

$I_{dAV} = 38 \text{ A}$   
 $V_{RRM} = 800-1600 \text{ V}$

Standard and Avalanche Types

$V_{RSM}$ V	$V_{BRmin}$ ① V	$V_{RRM}$ V	Standard Types	Avalanche Types
900		800	VBO 25-08NO2	
1300	1230	1200	VBO 25-12NO2	VBO 25-12AO2
1500	1430	1400	VBO 25-14NO2	VBO 25-14AO2
1700	1630	1600	VBO 25-16NO2	VBO 25-16AO2

① For Avalanche Types only

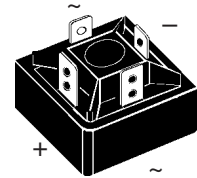
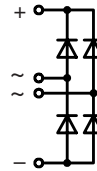

Symbol	Test Conditions	Maximum Ratings	Features	
$I_{dAV}$ ②	$T_C = 85^\circ\text{C}$ , module	38 A	<ul style="list-style-type: none"> <li>Avalanche rated parts available</li> <li>Package with DCB ceramic base plate</li> <li>Isolation voltage 3600 V~</li> <li>Planar passivated chips</li> <li>Low forward voltage drop</li> <li>1/4" fast-on terminals</li> <li>UL registered E 72873</li> </ul>	
$I_{dAVM}$	module	40 A		
$P_{RSM}$	$T_{VJ} = T_{VJM}$ t = 10 $\mu\text{s}$	3.4 kW		
$I_{FSM}$	$T_{VJ} = 45^\circ\text{C}$ ; $V_R = 0$	t = 10 ms (50 Hz), sine		370 A
		t = 8.3 ms (60 Hz), sine		390 A
$I^2t$	$T_{VJ} = 45^\circ\text{C}$ ; $V_R = 0$	t = 10 ms (50 Hz), sine		320 A
		t = 8.3 ms (60 Hz), sine		340 A
$T_{VJ}$	$T_{VJ} = T_{VJM}$ ; $V_R = 0$	t = 10 ms (50 Hz), sine		680 A <sup>2</sup> s
		t = 8.3 ms (60 Hz), sine		640 A <sup>2</sup> s
$T_{VJM}$	$T_{VJ} = T_{VJM}$	510 A <sup>2</sup> s		
$T_{stg}$	$V_R = 0$	470 A <sup>2</sup> s		
$V_{ISOL}$	50/60 Hz, RMS t = 1 min $I_{ISOL} \leq 1 \text{ mA}$ t = 1 s	3000 V~		
		3600 V~		
$M_d$	Mounting torque (M5) (10-32 UNF)	1.5-2 Nm 13-18 lb.in.		
Weight	typ.	15 g		

### Features

- Avalanche rated parts available
- Package with DCB ceramic base plate
- Isolation voltage 3600 V~
- Planar passivated chips
- Low forward voltage drop
- 1/4" fast-on terminals
- UL registered E 72873

### Applications

- Supplies for DC power equipment
- Input rectifiers for PWM inverter
- Battery DC power supplies
- Field supply for DC motors

### Advantages

- Easy to mount with one screw
- Space and weight savings
- Improved temperature and power cycling

### Dimensions in mm (1 mm = 0.0394")

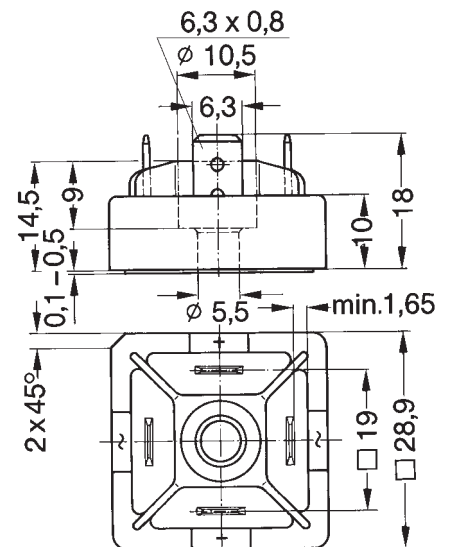

Symbol	Test Conditions	Characteristic Values
$I_R$	$V_R = V_{RRM}$ ; $T_{VJ} = 25^\circ\text{C}$	$\leq 0.3 \text{ mA}$
	$V_R = V_{RRM}$ ; $T_{VJ} = T_{VJM}$	$\leq 5 \text{ mA}$
$V_F$	$I_F = 55 \text{ A}$ ; $T_{VJ} = 25^\circ\text{C}$	$\leq 1.36 \text{ V}$
$V_{T0}$	For power-loss calculations only	0.85 V
$r_T$	$T_{VJ} = T_{VJM}$	8 m $\Omega$
$R_{thJC}$	per diode, DC current	2.8 K/W
	per module	0.7 K/W
$R_{thJK}$	per diode, DC current	3.2 K/W
	per module	0.8 K/W
$d_s$	Creeping distance on surface	13 mm
$d_A$	Creepage distance in air ③	9.5 mm
$a$	Max. allowable acceleration	50 m/s <sup>2</sup>

Data according to IEC 60747 and refer to a single diode unless otherwise stated  
 ② for resistive load at bridge output, ③ with isolated fast-on tabs.

IXYS reserves the right to change limits, test conditions and dimensions.

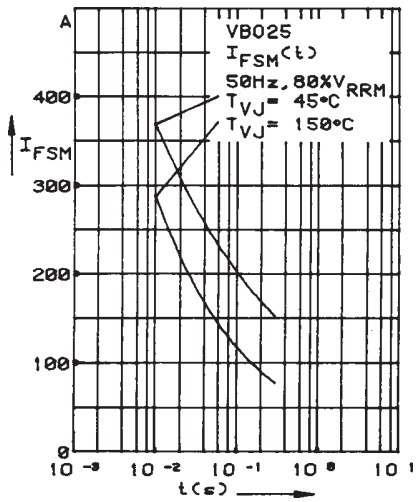

Fig. 1 Surge overload current per diode  
 $I_{FSM}$ : Crest value,  $t$ : duration

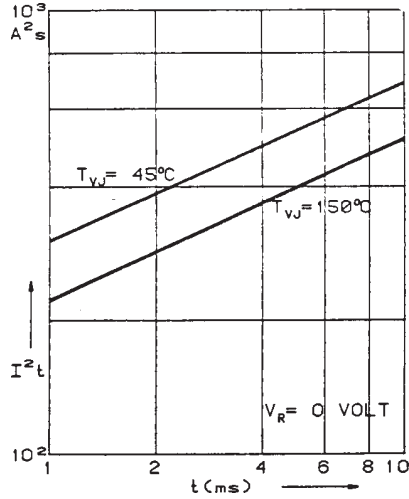

Fig. 2  $I^2t$  versus time (1-10 ms) per diode

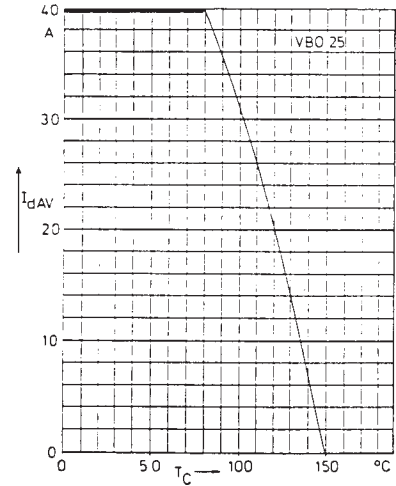

Fig. 3 Max. forward current at case temperature

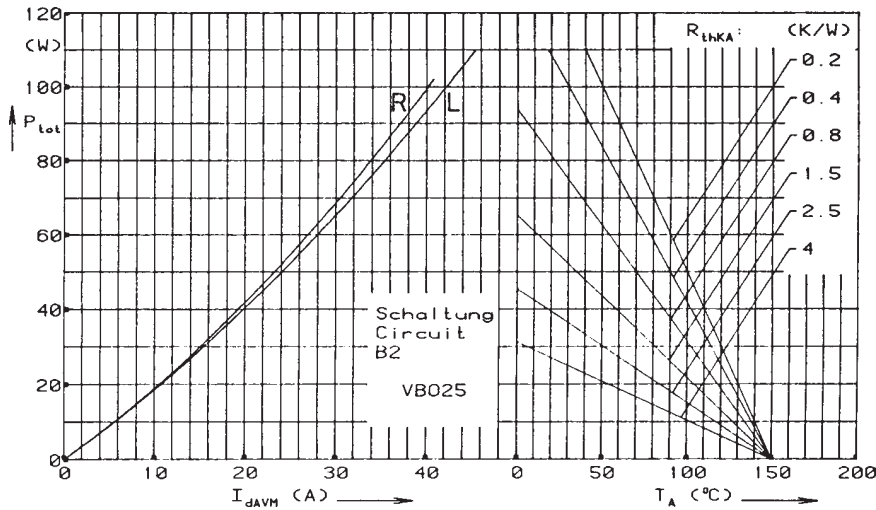

Fig. 4 Power dissipation versus direct output current and ambient temperature

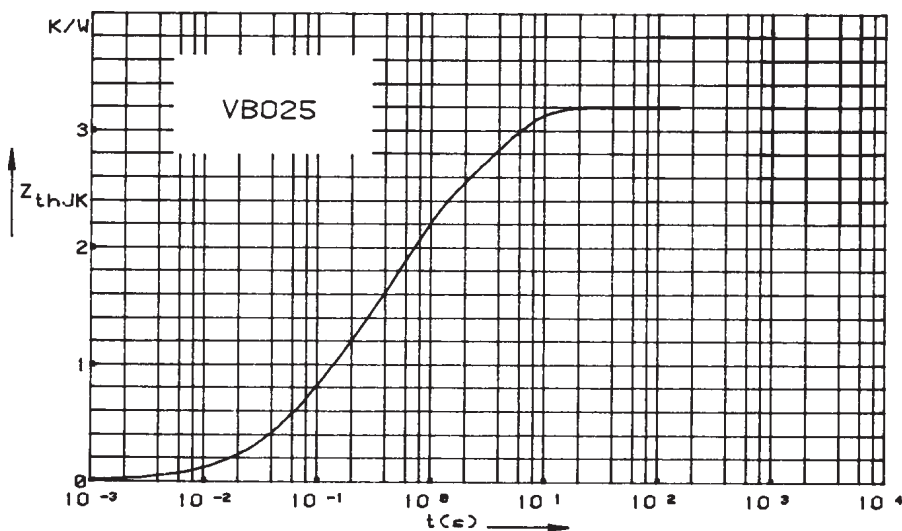

Fig. 5 Transient thermal impedance junction to heatsink per diode

IXYS reserves the right to change limits, test conditions and dimensions.

Constants for  $Z_{thJK}$  calculation:

i	$R_{thi}$ (K/W)	$t_i$ (s)
1	0.775	0.0788
2	1.390	0.504
3	1.055	3.701